

MDT 319

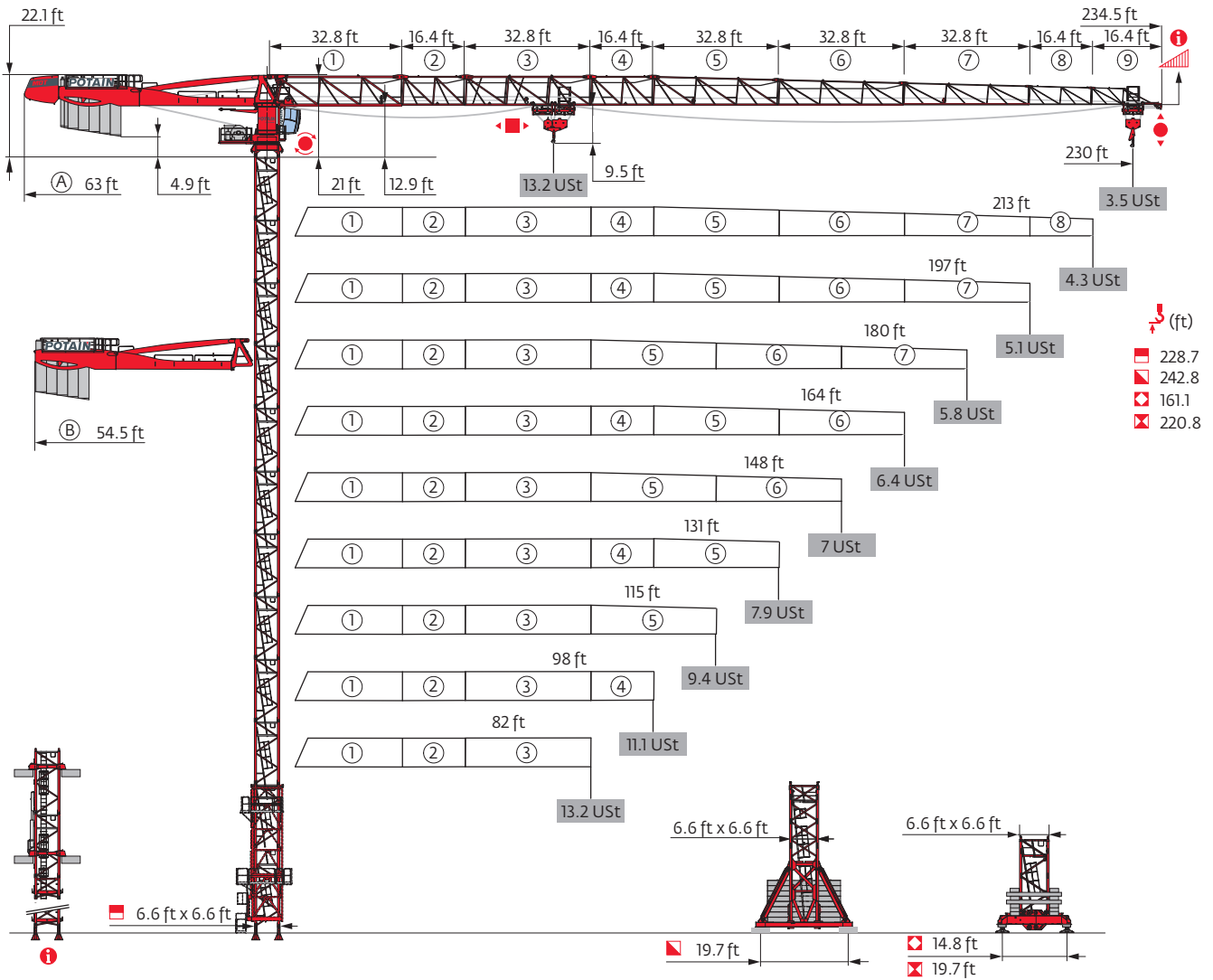

Potain Plus



Power Control

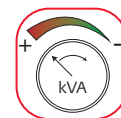

CraneSTAR



Top Site

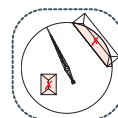

Top Tracing 3

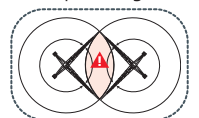

Mast - Reactions

6.6 ft - P 602B										
Height (ft)	82	98	115	131	148	164	180	197	213	230
Height (ft)	223.1	223.1	223.1	228.7	223.1	223.1	223.1	206.7	206.7	206.7
Height/P _r (ft)	223.1	223.1	223.1	228.7	223.1	223.1	223.1	206.7	206.7	206.7
10.9 ft	2	2	2	1	2	2	2	2	2	2
16.4 ft	12	12	12	13	12	12	12	11	11	11
F2 (Ust)	● 207	210	208	215	209	210	210	206	208	210
	■ 297	301	300	320	303	311	312	266	276	284
F3 (Ust)	● 147	148	145	149	144	143	143	139	141	143
	■ 243	245	244	261	244	251	252	206	215	223

6.6 ft - V 60A										
Height (ft)	82	98	115	131	148	164	180	197	213	230
Height (ft)	226	226	226	226	220.8	226	226	209.6	209.6	209.6
Height/P _r (ft)	226	226	226	226	220.8	226	226	209.6	209.6	209.6
10.9 ft	1	1	1	1	2	1	1	1	1	1
16.4 ft	12	12	12	12	11	12	12	11	11	11
F1 (Ust)	● 122	124	123	124	119	125	125	121	121	122
	■ 156	157	156	160	150	162	162	137	142	147

6.6 ft - V 63A										
Height (ft)	82	98	115	131	148	164	180	197	213	230
Height (ft)	237.2	242.8	242.8	242.8	237.2	237.2	237.2	220.8	226.4	226.4
Height/P _r (ft)	237.2	242.8	242.8	242.8	237.2	237.2	237.2	220.8	226.4	226.4
10.9 ft	2	1	1	1	2	2	2	2	1	1
16.4 ft	11	12	12	12	11	11	11	10	11	11
F1 (Ust)	● 136	140	140	141	136	136	136	128	131	135
	■ 176	186	185	188	178	182	183	156	169	174

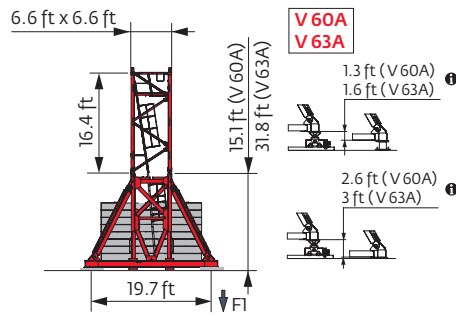
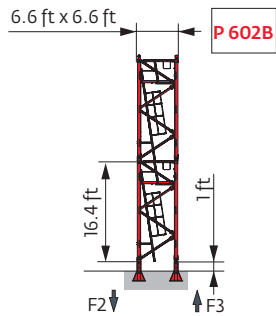

6.6 ft - ZD 463 -

WIND (ft)	82	98	115	131	148	164	180	197	213	230
\downarrow (ft)	161.1	155.5	161.1	155.5	161.1	161.1	161.1	149.9	144.7	149.9
\downarrow/P_{st} (ft)	161.1	155.5	161.1	155.5	161.1	161.1	161.1	149.9	144.7	149.9
10.9 ft	2	0	2	0	2	2	2	1	2	1
16.4 ft	8	9	8	9	8	8	8	8	7	8
FI (Ust)	● 116	113	114	113	115	115	115	115	111	115
	■ 107	101	105	102	107	109	109	101	97	106

6.6 ft - ZX 6830 -

WIND (ft)	82	98	115	131	148	164	180	197	213	230
\downarrow (ft)	215.2	220.8	220.8	220.8	215.2	220.8	220.8	204.4	204.4	204.4
\downarrow/P_{st} (ft)	215.2	220.8	220.8	220.8	215.2	220.8	220.8	204.4	204.4	204.4
10.9 ft	1	0	0	0	1	0	0	0	0	0
16.4 ft	12	13	13	13	12	13	13	12	12	12
FI (Ust)	● 116	119	119	120	116	121	121	117	118	119
	■ 139	148	147	150	141	153	153	128	133	138

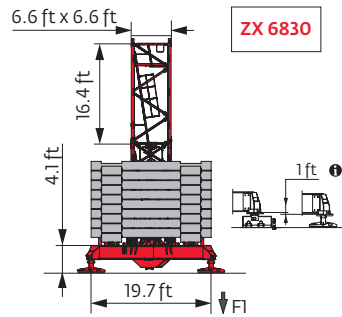
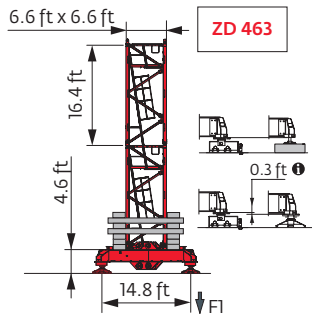

Note: When "ASCE" is noted in this data sheet it is referring to 115 mph Wind Zone, Exposure B, Design Wind Speed = 98 mph. See back cover for design wind speed calculations.

i Motorized accesses: adapted mast compositions, base ballast and reactions.

Anchorage

i

Base ballast

Ust) / 6.6 ft - V 60A -

(ft)	82	98	115	131	148	164	180	197	213	230
226	145.5	145.5	145.5	145.5	145.5	145.5	145.5			
220.8	145.5	145.5	132.3	132.3	132.3	132.3	132.3			
209.6	132.3	119.1	119.1	119.1	119.1	119.1	119.1	132.3	132.3	132.3
193.2	105.8	105.8	105.8	105.8	105.8	92.6	92.6	105.8	105.8	105.8
176.8	92.6	92.6	92.6	79.4	92.6	79.4	79.4	92.6	92.6	92.6
160.4	79.4	79.4	79.4	66.1	66.1	66.1	66.1	79.4	79.4	79.4
144	66.1	66.1	66.1	52.9	52.9	52.9	52.9	66.1	66.1	66.1
127.6	52.9	52.9	52.9	52.9	52.9	52.9	52.9	52.9	39.7	52.9
111.2	52.9	52.9	52.9	52.9	52.9	52.9	52.9	52.9	39.7	52.9
94.8	52.9	52.9	52.9	52.9	52.9	52.9	52.9	52.9	39.7	39.7
78.4	52.9	52.9	52.9	52.9	52.9	52.9	52.9	52.9	39.7	39.7
62	52.9	52.9	52.9	52.9	52.9	52.9	52.9	52.9	39.7	39.7

Ust) / 6.6 ft - V 63A -

(ft)	82	98	115	131	148	164	180	197	213	230
242.8	185.2	185.2	185.2							
237.2	185.2	172	172	172	172	172	172			
226.4	158.7	158.7	145.5	145.5	145.5	145.5	158.7		145.5	158.7
220.8	145.5	145.5	145.5	145.5	132.3	145.5	145.5	145.5	145.5	145.5
204.4	119.1	119.1	119.1	119.1	119.1	105.8	105.8	119.1	119.1	119.1
188	105.8	105.8	105.8	92.6	105.8	92.6	92.6	105.8	105.8	105.8
171.6	92.6	92.6	92.6	79.4	79.4	79.4	79.4	92.6	92.6	92.6
155.2	79.4	79.4	66.1	66.1	66.1	66.1	66.1	79.4	66.1	66.1
138.8	66.1	66.1	52.9	52.9	52.9	52.9	52.9	52.9	52.9	52.9
122.4	52.9	52.9	52.9	52.9	52.9	52.9	52.9	39.7	39.7	52.9
106	52.9	52.9	52.9	52.9	52.9	52.9	52.9	39.7	39.7	52.9
89.6	52.9	52.9	52.9	52.9	52.9	52.9	52.9	39.7	39.7	39.7
73.2	52.9	52.9	52.9	52.9	52.9	52.9	52.9	39.7	39.7	39.7

Ust) / 6.6 ft - ZD 463 -

(ft)	82	98	115	131	148	164	180	197	213	230
161.1	137.8		126.8		126.8	121.3	121.3			
155.5	126.8	126.8	121.3	121.3	121.3	110.2	110.2			
149.9	121.3	115.7	115.7	115.7	110.2	104.7	104.7	121.3		115.7
144.7	115.7	110.2	110.2	110.2	104.7	99.2	99.2	115.7	110.2	110.2
128.3	93.7	99.2	93.7	99.2	93.7	88.2	88.2	93.7	88.2	88.2
111.9	88.2	93.7	93.7	93.7	88.2	88.2	88.2	82.7	77.2	82.7
95.5	88.2	93.7	93.7	93.7	88.2	88.2	88.2	82.7	77.2	82.7
79.1	88.2	93.7	93.7	93.7	88.2	88.2	88.2	82.7	77.2	77.2

Ust) / 6.6 ft - ZX 6830 -

(ft)	82	98	115	131	148	164	180	197	213	230
220.8	133.4	133.4	133.4			133.4	133.4			
215.2	133.4	122.4	122.4	122.4	122.4	122.4	122.4			
204.4	122.4	111.3	111.3	100.3	111.3	100.3	100.3	122.4	122.4	122.4
188	100.3	100.3	100.3	89.3	89.3	89.3	89.3	100.3	100.3	100.3
171.6	89.3	78.3	78.3	78.3	78.3	67.2	67.2	89.3	78.3	78.3
155.2	67.2	67.2	67.2	56.2	67.2	56.2	56.2	67.2	67.2	67.2
138.8	56.2	56.2	56.2	56.2	56.2	45.2	45.2	56.2	45.2	45.2
122.4	45.2	56.2	56.2	56.2	56.2	45.2	45.2	45.2	45.2	45.2
106	45.2	56.2	56.2	56.2	56.2	45.2	45.2	45.2	45.2	45.2
89.6	45.2	56.2	56.2	56.2	56.2	45.2	45.2	45.2	45.2	45.2
73.2	45.2	56.2	56.2	56.2	56.2	45.2	45.2	45.2	45.2	45.2

Load curves



(ft)		72	82	89	98	105	115	121	131	138	148	154	164	171	180	187	197	203	213	220	230	ft	
MAX	13.2 USt 6.6 USt																						
230	10 → 74	136 - 148	13.2	11.8	10.9	9.7	9	8.1	7.6	6.9	6.6	6.6	6.4	5.8	5.5	5	4.7	4.3	4.1	3.8	3.6	3.3	USt
	10 → 75	137 - 148	13.2	11.9	10.9	9.7	9	8.1	7.6	6.9	6.6	6.6	6.4	5.9	5.7	5.3	5	4.6	4.3	4	3.8	3.5	USt P+
213	10 → 78	144 - 155	13.2	12.5	11.5	10.2	9.5	8.6	8.1	7.4	7	6.6	6.6	6.1	5.7	5.2	4.9	4.5	4.3	4			USt
	10 → 78	144 - 155	13.2	12.5	11.5	10.2	9.5	8.6	8.1	7.4	7	6.6	6.6	6.2	6	5.5	5.2	4.8	4.6	4.3			USt P+
197	10 → 82	152 - 164	13.2	13.2	12.2	10.9	10.1	9.2	8.6	7.9	7.4	6.9	6.6	6.5	6.1	5.6	5.3	4.9					USt
	10 → 82	153 - 164	13.2	13.2	12.2	10.9	10.1	9.2	8.6	7.9	7.4	6.9	6.6	6.6	6.3	5.9	5.5	5.1					USt P+
180	10 → 80	148 - 159	13.2	12.9	11.9	10.6	9.8	8.9	8.3	7.6	7.2	6.7	6.6	6.4	6.1	5.8							USt
	10 → 80	148 - 159	13.2	12.9	11.9	10.6	9.8	8.9	8.3	7.6	7.2	6.7	6.6	6.4	6.1	5.8							USt P+
164	10 → 81	149 - 161	13.2	13	11.9	10.6	9.9	8.9	8.4	7.7	7.3	6.7	6.6	6.4									USt
	10 → 81	149 - 161	13.2	13	11.9	10.6	9.9	8.9	8.4	7.7	7.3	6.7	6.6	6.4									USt P+
148	10 → 84		13.2	13.2	12.4	11	10.3	9.3	8.7	8	7.6	7											USt
	10 → 84		13.2	13.2	12.4	11	10.3	9.3	8.7	8	7.6	7											USt P+
131	10 → 84		13.2	13.2	12.4	11	10.2	9.2	8.6	7.9													USt
	10 → 84		13.2	13.2	12.4	11	10.2	9.2	8.6	7.9													USt P+
115	10 → 84		13.2	13.2	12.5	11.1	10.3	9.3															USt
	10 → 84		13.2	13.2	12.5	11.1	10.3	9.3															USt P+
98	10 → 84		13.2	13.2	12.5	11.1																	USt
	10 → 84		13.2	13.2	12.5	11.1																	USt P+
82	10 → 82		13.2	13.2																			USt
	10 → 82		13.2	13.2																			USt P+

$W_{jib} = W_{counter-jib} - 0.72 \text{ USt max.}$



(ft)		72	82	89	98	105	115	121	131	138	148	154	164	171	180	187	197	203	213	220	230	ft	
MAX	13.2 USt 6.6 USt																						
230	8 → 74	137 - 139	13.2	11.9	11	9.7	9.1	8.2	7.7	7	6.6	6.2	5.9	5.4	5	4.5	4.2	3.8	3.6	3.3	3.1	2.9	USt
	8 → 75	138 - 140	13.2	11.9	11	9.7	9	8.2	7.7	7	6.6	6.2	5.9	5.5	5.2	4.8	4.5	4.2	3.9	3.6	3.4	3.1	USt P+
213	8 → 78	145 - 148	13.2	12.6	11.6	10.3	9.6	8.7	8.1	7.4	7	6.6	6.3	5.7	5.3	4.8	4.5	4.1	3.9	3.6			USt
	8 → 78	145 - 148	13.2	12.6	11.6	10.3	9.6	8.6	8.1	7.4	7	6.6	6.3	5.8	5.6	5.1	4.8	4.4	4.2	3.9			USt P+
197	8 → 83	153 - 157	13.2	13.2	12.3	10.9	10.2	9.2	8.7	7.9	7.5	6.9	6.6	6.2	5.8	5.2	4.9	4.5					USt
	8 → 83	154 - 157	13.2	13.2	12.3	11	10.2	9.2	8.7	7.9	7.5	6.9	6.6	6.3	6	5.5	5.2	4.8					USt P+
180	8 → 81	150 - 152	13.2	13	11.9	10.6	9.9	8.9	8.4	7.7	7.3	6.7	6.5	6.1	5.8	5.4							USt
	8 → 81	150 - 152	13.2	13	11.9	10.6	9.9	8.9	8.4	7.7	7.3	6.7	6.5	6.1	5.8	5.4							USt P+
164	8 → 81	151 - 154	13.2	13.1	12	10.7	10	9	8.5	7.7	7.3	6.8	6.6	6.1									USt
	8 → 81	151 - 154	13.2	13.1	12	10.7	10	9	8.5	7.7	7.3	6.8	6.6	6.1									USt P+
148	8 → 84		13.2	13.2	12.5	11.1	10.3	9.4	8.8	8.1	7.6	7											USt
	8 → 84		13.2	13.2	12.5	11.1	10.3	9.4	8.8	8.1	7.6	7											USt P+
131	8 → 84		13.2	13.2	12.5	11.1	10.3	9.3	8.7	7.9													USt
	8 → 84		13.2	13.2	12.5	11.1	10.3	9.3	8.7	7.9													USt P+
115	8 → 85		13.2	13.2	12.5	11.1	10.4	9.4															USt
	8 → 85		13.2	13.2	12.5	11.1	10.4	9.4															USt P+
98	8 → 85		13.2	13.2	12.6	11.1																	USt
	8 → 85		13.2	13.2	12.6	11.1																	USt P+
82	8 → 82		13.2	13.2																			USt
	8 → 82		13.2	13.2																			USt P+

$W_{jib} = W_{counter-jib} - 0.21 \text{ USt max.}$

Jib weight & counter-jib ballast

(ft)	(lb) (+/- 5%)								
				10,141 lb	3,373 lb	(lb)	6,768 lb	3,373 lb	(lb)
230 ft	32,320	31,526	32,430	5	2	57,452	8	1	57,519
213 ft	31,658	30,931	31,780	5	2	57,452	8	1	57,519
197 ft	30,799	30,137	30,931	5	2	57,452	8	1	57,519
180 ft	28,704	28,043	28,836	5	0	50,706	7	1	50,750
164 ft	28,991	28,329	29,123	5	0	50,706	7	1	50,750
148 ft	26,896	26,235	27,029	4	2	47,311	7	0	47,377
131 ft	26,566	25,904	26,698	4	1	43,938	6	1	43,982
115 ft	24,736	24,074	24,868	4	0	40,565	6	0	40,609
98 ft	23,391	22,730	23,523	3	2	37,170	5	1	37,214
82 ft	21,738	21,076	21,870	3	1	33,797	5	0	33,841

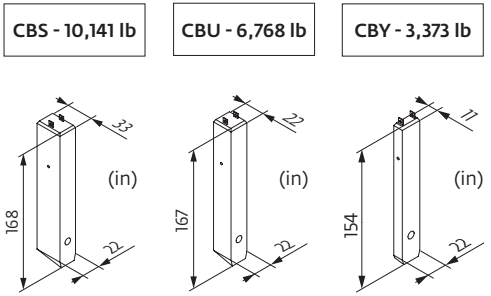





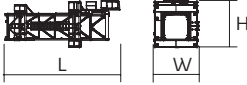

Dimensions and weight

Slewing crane part:  230 ft -  -  50 LVF

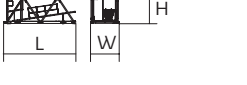

Slewing crane part		L (ft)	W (ft)	H (ft)	lb (+/- 5%)
Counter-jib		36.1 36.1	3.7 3.7	8.1 8.1	21,826 20,503
Cab mast + cab		16.1	7.3	8.2	13,228
Towerhead + Hoisting winch (+ rope)		17.3	8.3	9.2	21,054
Towerhead		9.7	8.1	8.2	13,228
Hoisting winch (+ rope)		14	7.5	7.6	9,921
Jib section		35.8	5.6	9	9,348
Jib section		33.8 33.5 33.6 33.4	3.9 3.9 3.9 3.9	7.9 7.8 6.9 6	5,335 3,439 2,723 1,753
Jib section		17.6 17.3 16.7 16.7	3.9 3.9 3.9 3.9	8 7.8 5 4.6	3,164 2,116 683 485
Trolley		6.1	5	3.4	882
Pulley block		3.9	1.4	7.6	1,003
Trolley		5.2	5	3.2	463
Trolley		5.6 6.1	5 5	3.4 3.2	540 520
Pulley block		5.4 3.6	0.7 0.9	5.8 5.3	992 584

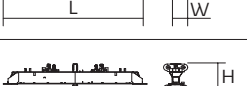
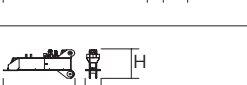
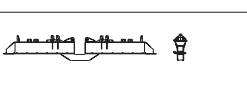
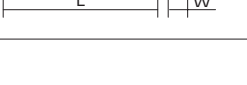
Crane tower		L (ft)	W (ft)	H (ft)	lb (+/- 5%)	
Telescopic cage T 61		6.6 ft	35.5	13.6	14.7	21,385
K 649B KM 649E		6.6 ft	33.6 33.8	6.8 6.7	6.7 6.7	11,663 10,692
KR 649A KRMT 649A K 649A KMT 649A		6.6 ft	17.2 17.2 17.2 17.2	6.9 6.9 6.8 6.8	6.8 6.8 6.7 6.7	7,165 6,724 6,184 5,666
K 649C KMT 649C KRMT 649C		6.6 ft	11.7 11.7 11.7	6.8 6.8 6.9	6.7 6.7 6.8	4,376 4,542 5,401
Fixing angles		P 602B	2.1	2.1	4.2	650
Basic mast unit		V 60A V 63A	16.4 32.9	7.9 7.9	7.9 7.9	9,674 16,502
Struts		V 60A V 63A	14.8 14.8	1 1.1	1 1.1	919 1,135
Half-bearer		V 60A V 63A	22 22	2.3 2.3	7.6 7.6	3,519 4,079
Cross girder		ZD 463	25.1	3.8	4.5	7,904
1/2 Cross girder		ZD 463	11.2	2.3	4.4	3,649
Cross girder		ZX 6830	29.9 29.9	2.5 3.7	4.9 3.6	12,004 11,607

Mechanisms

480 V - 60 Hz											hp	kW			
	50 LVF 30 Optima	fpm	105	135	185	267	54	71	97	135	50	37	1,106 ft		
		USt	6.6	5	3.3	1.1	13.2	9.9	6.6	2.5					
	90 HPL™ 30	fpm	176	228	326	469	723	90	120	172	244	361	90	66	2,772 ft
		USt	6.6	5	3.3	1.7	0.2	13.2	9.9	6.6	3.3	0.9			
	6 DVF 4 Optima	fpm	0 → 164 (13.2 USt) 0 → 328 (6.6 USt) 0 → 394 (3.3 USt)								5.5	4			
	RVF 162 Optima+	rpm					0 → 0.9				2 x 7.5	2 x 5.5			

480 V (+6% -10%) 60 Hz	50 LVF: 58 → 38 kVA 90 HPL™: 90 → 54 kVA	

50 LVF 30 Optima

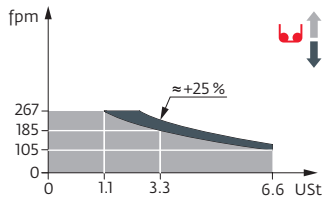

These most combinations meet the EN 14439 and ASME B30.3-2016 specifications for “out of service” wind conditions, provided the illustrated wind speed matches required design wind speed for the location of the tower crane. The “out of service” design wind speed was determined in accordance with ASCE 7-10, Figure 26.5-1A. The wind velocity, used for this configuration was 98 mph (158 kph), which represents a nominal design 3-second wind gust at 33 ft (10 m) above ground for Exposure B category. A factor of 0.85 was applied to the 700-year ultimate design wind speed of 115 mph (185 kph), per ASCE 37-02, with the assumption that this crane is considered a temporary structure used during a construction period of 2 years or less.

- Jib elevation
- Total ballast weight
- Travelling
- Standard equipment
- Jib weight
- Required power
- Options
- Lorry 44 ft
- Power Control Function: wind speeds adapted to the available power
- Potain Plus function: Plus load curves
- Container High Cube 40 ft, and/or Flat Rack 20 ft
- Consult us
- Hook heights with Plus load curves
- Hoisting
- Reactions in service
- Trolleying
- Reactions out of service
- Slewing

This commercial document is not legally binding. For any technical information, please refer to the corresponding instructions.

