

MAXIM
1-877-MAX-LIFT

GROVE[®]
by **Manitowoc**

GRT8100

Product Guide

ANSI B30.5
Imperial 85%



Features

- 100 t (100 USt) capacity
- 12 m – 47 m (39.2 ft – 154.3 ft) five-section full-power boom
- 10 m – 17 m (33 ft – 56 ft) manual offsettable bi-fold lattice swingaway extension
- 9979 kg (22,000 lb) standard counterweight hydraulically installed and removed
- Intuitive, user friendly controls with electronic joysticks and operator customizable function speeds
- Full vision cab with 20° tilt feature

GROVE GRT8100

The GRT8100 was designed after gathering feedback from crane owners and operators to ensure that it is loaded with the features and reliability you demand.

Features

> Cab

The cab is designed with operator comfort and productivity in mind with full-vision design and 20° tilt for improved viewing at high boom angles. The tilt/telescoping steering wheel can be positioned for optimum use.



> Control system

The new Crane Control System (CCS) offers a user-friendly interface, two full graphic displays mounted vertically for easier viewing and a jog dial for easier navigation and data input. The system allows the electronic controllers to be reprogrammed by the operator for specific speed and reaction. Parts commonality across Grove, Manitowoc and Potain product lines enhances operator familiarization and serviceability.



> Boom

Lifting performance is enhanced by the 12 m – 47 m (39.2 ft – 154.3 ft) five-section, full-power MEGAFORM™ boom with sequenced, synchronized extension capability. The boom system offers three operational modes of extension and retraction and one mode specifically for maintenance.

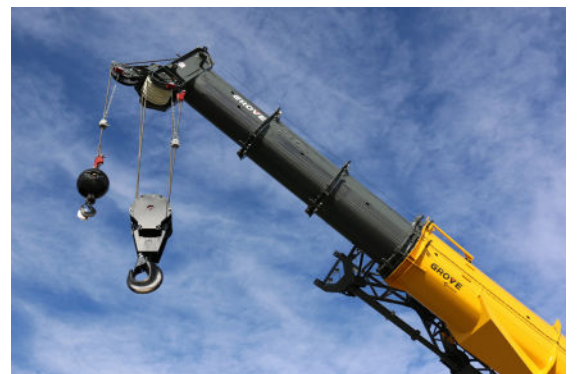

> Backing up our promise

We stand behind our new line of GRT cranes, and we are willing to prove it. With new three-, four- or five-year extended warranty programs as well as a new two-year standard warranty; our GRT line of cranes are built to be GROVE REAL TOUGH.

THE ONLY FIVE-YEAR
WARRANTY PROGRAM
AVAILABLE IN THE INDUSTRY

GRT8100 benefits

- > Higher nominal capacity and stronger load charts ensure higher rental rates.
- > Outstanding height and reach provide higher utilization and greater versatility.
- > The GRT8100 transports to the job site quickly and efficiently with a weight under 42 749 kg (94,246 lb) after removal of counterweight and boom extension.
- > Counterweight is hydraulically self-removable and installed by the crane.
- > Three operator selectable telescoping modes for flexibility in any application.
- > ECO mode for intelligent power management and decreased fuel consumption.



Manitowoc Crane Care when you need it.
The assurance of the world's most advanced crane service and support to get you back to work fast.



Manitowoc Finance helps you get right to work generating profits for your business.
Financial tools that help you capitalize on opportunity with solutions that fit your needs.

Contents

- Dimensions 5
- Weights 6
- Working range 7
- Main boom range / load charts 8
- Working range with bi-fold extension 11
- Extensions range / load charts 12
- Rigging charts..... 27
- Load handling 28
- Specifications..... 29

Dimensions

Tire Size: 29.5 x 25													
A	B	C	D	E	F	G	A	B	C	D	E	F	G
16,3 m (53' 6")	16,8 m (55' 1")	13,6 m (44' 7")	12,9 m (42' 4")	12,5 m (41' 0")	10,1 m (33' 2")	8,8 m (28' 10")	11,8 m (38' 9")	12,2 m (40' 0")	8,4 m (27' 7")	7,7 m (25' 3")	7,3 m (23' 11")	4,9 m (16' 1")	4,6 m (15' 1")
Two-Wheel Steer							Four-Wheel Steer						

Dimensions in mm (in) unless otherwise specified.

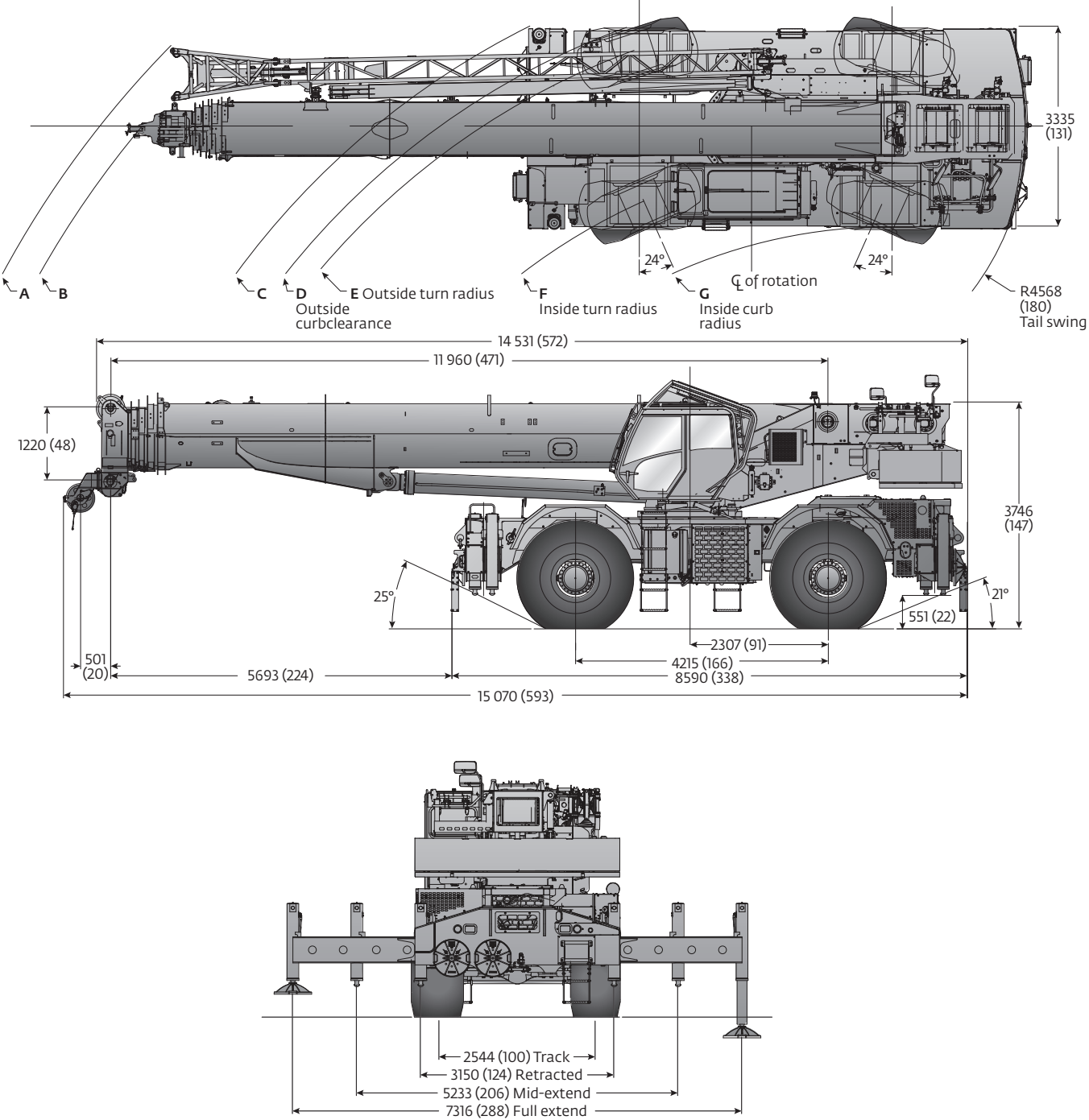

Weights

Weights						
	GVW		Front		Rear	
	kg	lb	kg	lb	kg	lb
Basic Machine (T4F): including 47 m (154.3 ft) main boom, main and auxiliary hoist with 214 m (702 ft) of rope, manual offsettable bi-fold swingaway, 9980 kg (22,000 lb) counterweight, 11 t (12 USt) headache ball, and 81,5 t (90 USt) hook block.	54 073	119,211	28 944	63,811	25 129	55,400
Add: 2268 kg (5000 lb) heavy counterweight	2255	4971	-827	-1824	3082	6795
crane weight	56 328	124,182	28 117	61,987	28 211	62,195
Remove: 9980 kg (22,000 lb) counterweight (manual offsettable S/A)	-10 000	-22,046	3735	8234	-13 735	-30,280
crane weight	44 073	97,165	32 679	72,045	11 394	25,120
Remove: 12 247 kg (27,000 lb) counterweight (manual offsettable S/A)	-12 255	-27,017	4562	10,058	-16 817	-37,075
crane weight	44 073	97,165	32 679	72,045	11 394	25,120
Remove: manual bi-fold extension	-1324	-2919	-2321	-5116	997	2,197
crane weight	42 749	92,246	30 358	66,929	12 391	27,317
Basic unit as noted above SUB: Hydraulic offsettable bi-fold swingaway	54 220	119,534	29 286	64,564	24 934	54,970
Basic unit with heavy counterweight Hydraulic offsettable bi-fold swingaway	56 475	124,505	28 458	62,740	28 016	61,765
Remove: 9980 kg (22,000 lb) counterweight (Hydraulic offsettable S/A)	-10 000	-22,046	3735	8234	-13 735	-30,280
crane weight	44 220	97,488	33 021	72,798	11 199	24,690
Remove: 12 247 kg (27,000 lb) counterweight (Hydraulic offsettable S/A)	-12 255	-27,017	4562	10,058	-16 817	-37,075
crane weight	44 220	97,488	33 021	72,798	11 199	24,690
Remove: Hydraulic bi-fold extension	-1317	-2904	-2307	-5085	989	2181
crane weight	42 903	94,584	30 714	67,713	12 188	26,871

THIS CHART IS ONLY A GUIDE AND SHOULD NOT BE USED TO OPERATE THE CRANE.

The individual crane's load chart, operating instructions and other instructional plates must be read and understood prior to operating the crane

Working range

Working range diagram with bi-fold extension

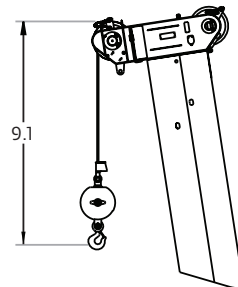
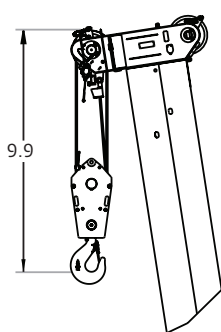
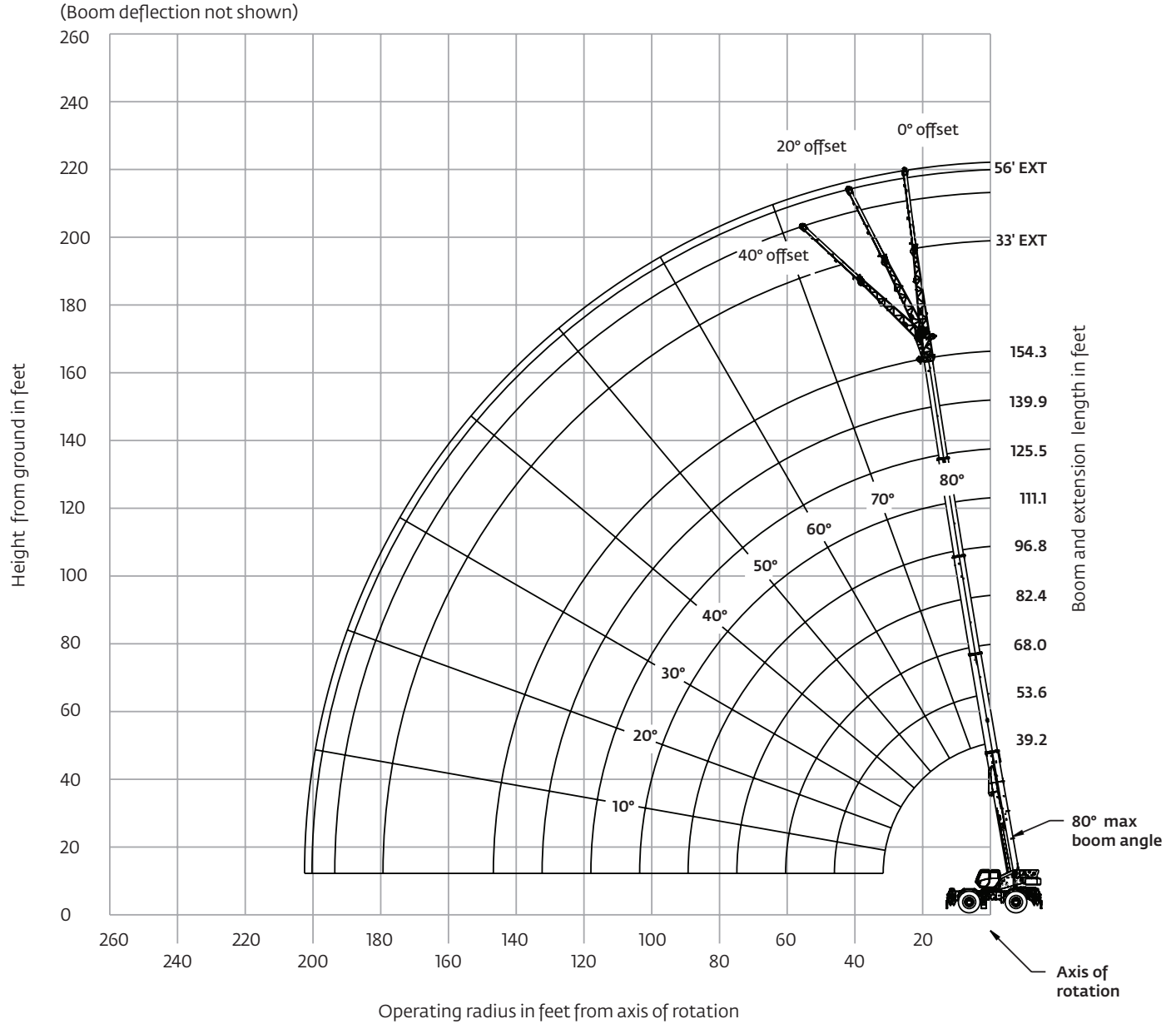

Dimensions are for the largest Grove furnished hook block and overhaul ball, with anti-two block activated.

*THIS CHART IS ONLY A GUIDE AND SHOULD NOT BE USED TO OPERATE THE CRANE.
The individual crane's load chart, operating instructions and other instructional plates must be read and understood prior to operating the crane*

Load chart



39.2 ft - 154.3 ft



22,000 lb



100%



360°



Pounds

Feet	Main boom length in feet											
	39.2	53.6	53.6	68.0	68.0	68.0	82.4	82.4	82.4	96.8	96.8	96.8
Tele I	0%	0%	50%	0%	50%	100%	0%	50%	100%	0%	50%	100%
Tele II	0%	17%	0%	33%	17%	0%	50%	33%	17%	67%	50%	33%
Tele III	0%	17%	0%	33%	17%	0%	50%	33%	17%	67%	50%	33%
Tele IV	0%	17%	0%	33%	17%	0%	50%	33%	17%	67%	50%	33%
Mode	A,X, B	A	X,B	A	X	B	A	X	B	A	X	B
8	200,000 (72.5)	—	—	—	—	—	—	—	—	—	—	—
9	187,500 (71)	—	—	—	—	—	—	—	—	—	—	—
10	177,000 (69)	56,100 (75.5)	136,500 (75.5)	55,550 (78.5)	55,500 (78.5)	97,600 (79)	*55,500 (80)	*55,500 (80)	*55,450 (80)	—	—	—
12	158,500 (66)	56,100 (73)	136,500 (73)	55,550 (77)	55,500 (77)	97,600 (77)	55,500 (79.5)	55,500 (79.5)	55,450 (79.5)	—	—	—
15	135,500 (61)	56,100 (69.5)	134,500 (69.5)	55,550 (74)	55,500 (74)	93,750 (74.5)	55,500 (77)	55,500 (77)	55,450 (77.5)	37,850 (79.5)	55,500 (79.5)	55,450 (79.5)
20	103,000 (51.5)	56,100 (63.5)	102,000 (63.5)	55,550 (69.5)	55,500 (69.5)	76,300 (70)	55,500 (73.5)	55,500 (73.5)	55,450 (74)	37,850 (76.5)	55,500 (76.5)	55,450 (76.5)
25	79,800 (40)	56,100 (57)	78,200 (57)	55,550 (65)	55,500 (65)	63,400 (65)	55,500 (70)	55,500 (69.5)	55,450 (70)	37,850 (73.5)	55,500 (73.5)	54,200 (73.5)
30	59,750 (23.5)	56,100 (50)	55,250 (50)	55,550 (60)	55,500 (60)	53,800 (60.5)	55,500 (66)	55,500 (66)	49,150 (66.5)	37,850 (70)	55,500 (70)	46,150 (70.5)
35	—	46,000 (42)	41,900 (42)	46,950 (55)	43,900 (55)	43,500 (55)	47,750 (62)	45,800 (62)	42,300 (62.5)	34,400 (67)	47,850 (67)	39,750 (67)
40	—	35,800 (32.5)	32,650 (32)	37,200 (49.5)	34,700 (49)	33,200 (49.5)	38,200 (58)	36,100 (58)	34,300 (58.5)	30,550 (63.5)	38,100 (63.5)	34,600 (64)
45	—	28,650 (16.5)	25,000 (16.5)	30,350 (43.5)	28,200 (43)	25,950 (43.5)	31,450 (53.5)	29,300 (53.5)	27,150 (54)	27,350 (60)	30,900 (60)	28,250 (60.5)
50	—	—	—	25,100 (36)	22,600 (36)	20,450 (36)	26,450 (49)	24,200 (48.5)	21,800 (49.5)	24,750 (56.5)	25,550 (56.5)	22,950 (57)
55	—	—	—	21,050 (27)	18,200 (27)	16,200 (27)	22,600 (44)	20,300 (43.5)	17,650 (44)	22,500 (53)	21,450 (53)	18,850 (53)
60	—	—	—	17,800 (11)	14,700 (10.5)	12,800 (11)	19,500 (38.5)	17,150 (38)	14,300 (38.5)	19,950 (49)	18,150 (49)	15,550 (49)
65	—	—	—	—	—	—	16,900 (31.5)	14,550 (31.5)	11,550 (32)	17,350 (45)	15,400 (44.5)	12,900 (45)
70	—	—	—	—	—	—	14,550 (23)	12,350 (23)	9280 (23.5)	15,100 (40)	13,150 (40)	10,700 (40)
75	—	—	—	—	—	—	—	—	—	13,200 (35)	11,250 (34.5)	8770 (35)
80	—	—	—	—	—	—	—	—	—	11,500 (28.5)	9570 (28.5)	7120 (28.5)
85	—	—	—	—	—	—	—	—	—	9990 (20.5)	8080 (20)	5690 (20.5)
Minimum boom angle (°) for indicated length (no load)												0
Maximum boom length (ft) at 0° boom angle (no load) – Mode A and X												125.5
Maximum boom length (ft) at 0° boom angle (no load) – Mode B												111.1

*This capacity is based on maximum boom angle

Boom angle	Lifting capacities at 0° boom angle											
	39.2	53.6	53.6	68.0	68.0	68.0	82.4	82.4	82.4	96.8	96.8	96.8
0°	28,350 (31.7)	18,300 (46.1)	16,000 (46.1)	13,100 (60.5)	10,600 (60.5)	8410 (60.5)	9240 (74.8)	7240 (74.8)	5390 (74.8)	6590 (89.2)	4920 (89.2)	3380 (89.2)

NOTE: () Reference radii in feet.

Shaded area indicates optimal lift capacity within boom length sections.

THIS CHART IS ONLY A GUIDE AND SHOULD NOT BE USED TO OPERATE THE CRANE.

80081371-1

The individual crane's load chart, operating instructions and other instructional plates must be read and understood prior to operating the crane

Load chart

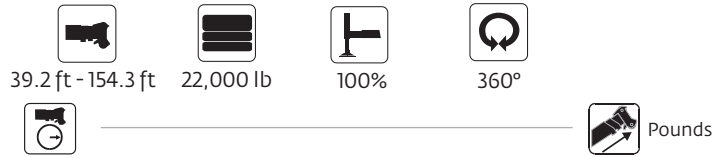

Feet	Main boom length in feet <i>cont'd</i>								
	111.1	111.1	111.1	125.5	125.5	125.5	139.9	139.9	154.3
Tele I	0%	50%	100%	0%	50%	100%	50%	100%	100%
Tele II	83%	67%	50%	100%	83%	67%	100%	83%	100%
Tele III	83%	67%	50%	100%	83%	67%	100%	83%	100%
Tele IV	83%	67%	50%	100%	83%	67%	100%	83%	100%
Mode	A	X	B	A	X	B	A, X	B	A, X, B
15	*26,350 (80)	*37,750 (80)	*54,500 (80)	—	—	—	—	—	—
20	26,350 (78.5)	37,750 (78.5)	54,500 (78.5)	21,650 (80)	26,300 (80)	*37,700 (80)	*21,600 (80)	*26,250 (80)	—
25	26,350 (76)	37,750 (76)	50,600 (76)	21,650 (78)	26,300 (78)	37,700 (78)	21,600 (79.5)	26,250 (79.5)	*21,550 (80)
30	26,350 (73)	37,750 (73.5)	43,800 (73.5)	21,650 (75.5)	26,300 (75.5)	37,700 (75.5)	21,600 (77.5)	26,250 (77.5)	21,550 (79)
35	26,350 (70.5)	37,750 (70.5)	37,950 (70.5)	21,650 (73)	26,300 (73)	36,300 (73)	21,600 (75)	26,250 (75.5)	21,550 (77)
40	26,350 (67.5)	34,300 (68)	33,050 (67.5)	21,650 (70.5)	26,300 (70.5)	31,900 (70.5)	21,600 (73)	26,250 (73)	21,550 (75)
45	24,400 (65)	30,950 (65)	29,100 (65)	21,650 (68)	26,300 (68)	28,100 (68)	21,600 (71)	26,250 (71)	21,550 (73)
50	22,000 (62)	26,900 (62)	24,050 (62)	20,050 (65.5)	24,550 (65.5)	24,650 (66)	21,600 (68.5)	24,200 (69)	21,150 (71)
55	19,900 (59)	22,550 (59)	20,000 (59)	18,100 (63)	22,350 (63)	20,550 (63.5)	20,050 (66.5)	21,150 (66.5)	21,150 (69)
60	18,150 (56)	19,100 (56)	16,750 (56)	16,450 (60.5)	19,300 (60.5)	17,300 (60.5)	18,300 (64)	17,900 (64.5)	18,500 (67.5)
65	16,600 (52.5)	16,300 (52.5)	14,100 (52.5)	15,000 (58)	16,550 (58)	14,700 (58)	16,750 (62)	15,250 (62)	15,850 (65.5)
70	15,250 (49)	13,950 (49)	11,900 (49)	13,700 (55)	14,300 (55)	12,500 (55)	14,600 (59.5)	13,100 (59.5)	13,650 (63.5)
75	13,650 (45.5)	12,000 (45.5)	10,050 (45.5)	12,600 (52)	12,350 (52)	10,650 (52)	12,700 (57)	11,250 (57.5)	11,800 (61)
80	12,000 (41.5)	10,300 (41.5)	8,470 (41.5)	11,600 (49)	10,700 (49)	9,080 (49)	11,100 (54.5)	9,670 (54.5)	10,250 (59)
85	10,550 (37)	8,810 (37)	7,060 (37)	10,700 (46)	9,310 (45.5)	7,710 (46)	9,750 (52)	8,300 (52)	8,890 (56.5)
90	9,340 (32)	7,510 (32)	5,820 (32)	9,760 (42.5)	8,060 (42)	6,510 (42.5)	8,540 (49)	7,110 (49.5)	7,700 (54.5)
95	8,190 (26)	6,350 (26)	4,730 (26)	8,650 (38.5)	6,940 (38.5)	5,430 (38.5)	7,470 (46)	6,060 (46.5)	6,640 (52)
100	7,150 (18)	5,330 (18)	3,750 (18)	7,670 (34.5)	5,940 (34.5)	4,460 (34.5)	6,520 (43)	5,120 (43.5)	5,710 (49.5)
105	—	—	—	6,800 (29.5)	5,040 (29.5)	3,600 (29.5)	5,650 (39.5)	4,260 (40)	4,880 (47)
110	—	—	—	6,010 (24)	4,240 (24)	2,830 (24)	4,860 (36)	3,490 (36.5)	4,130 (44)
115	—	—	—	5,300 (16)	3,510 (16)	2,120 (16)	4,150 (32)	2,790 (32.5)	3,430 (41)
120	—	—	—	—	—	—	3,510 (27.5)	2,150 (28)	2,800 (38)
125	—	—	—	—	—	—	2,900 (22)	1,550 (22)	2,220 (34.5)
130	—	—	—	—	—	—	2,340 (14)	1,000 (14)	1,690 (30.5)
135	—	—	—	—	—	—	—	—	1,180 (26)
Minimum boom angle (°) for indicated length (no load)						15	13	13	25
Maximum boom length (ft) at 0° boom angle (no load) - Mode A and X									125.5
Maximum boom length (ft) at 0° boom angle (no load) - Mode B									111.1

*This capacity is based on maximum boom angle

Boom angle	Lifting capacities at 0° boom angle <i>cont'd</i>								
	111.1	111.1	111.1	125.5	125.5	125.5	139.9	139.9	154.3
0°	4680 (103.6)	3230 (103.6)	1910 (103.6)	3230 (118)	1950 (118)	—	—	—	—

NOTE: () Reference radii in feet.

Shaded area indicates optimal lift capacity within boom length sections.

THIS CHART IS ONLY A GUIDE AND SHOULD NOT BE USED TO OPERATE THE CRANE.

The individual crane's load chart, operating instructions and other instructional plates must be read and understood prior to operating the crane

80081371-2

Load chart

Manual extension

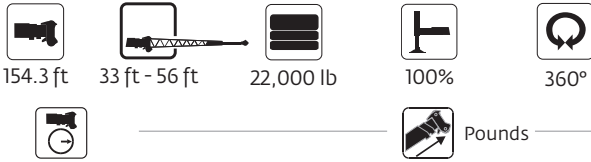

Feet	33 ft length			56 ft length		
	0° offset	20° offset	40° offset	0° offset	20° offset	40° offset
30	*13,900 (80)	—	—	—	—	—
35	13,900 (79.5)	—	—	*7960 (80)	—	—
40	13,900 (78)	*13,600 (80)	—	7960 (79)	—	—
45	13,900 (76.5)	13,600 (79.5)	—	7960 (78)	—	—
50	13,900 (75)	13,600 (78)	11,750 (80)	7960 (76.5)	—	—
55	13,900 (73.5)	13,600 (76.5)	11,600 (78.5)	7960 (75.5)	6700 (80)	—
60	13,900 (72)	13,550 (75)	11,450 (76.5)	7960 (74)	6450 (79)	—
65	13,900 (70.5)	13,300 (73)	11,300 (75)	7960 (72.5)	6240 (77.5)	*5000 (80)
70	13,900 (69)	13,000 (71.5)	11,150 (73.5)	7600 (71.5)	6040 (76)	5000 (79.5)
75	12,100 (67.5)	12,750 (70)	11,050 (71.5)	7190 (70)	5850 (74.5)	4900 (78)
80	10,500 (66)	11,500 (68.5)	10,950 (70)	6780 (68.5)	5660 (73)	4810 (76.5)
85	9150 (64.5)	10,050 (66.5)	10,750 (68)	6450 (67.5)	5500 (72)	4730 (74.5)
90	7930 (62.5)	8750 (64.5)	9370 (66.5)	6120 (66)	5350 (70.5)	4650 (73)
95	6870 (60.5)	7600 (63)	8170 (64.5)	5860 (64.5)	5200 (69)	4580 (71.5)
100	5920 (58.5)	6580 (61)	7100 (62.5)	5600 (63)	5050 (67.5)	4510 (69.5)
105	5070 (56.5)	5670 (58.5)	6140 (60.5)	5360 (61.5)	4920 (66)	4450 (68)
110	4310 (54.5)	4860 (56.5)	5280 (58)	4900 (60)	4800 (64)	4390 (66)
115	3620 (52.5)	4120 (54.5)	4500 (56)	4220 (58.5)	4690 (62.5)	4340 (64.5)
120	3000 (50)	3450 (52.5)	3800 (53.5)	3610 (56.5)	4580 (60.5)	4290 (62.5)
125	2430 (48)	2830 (50)	3150 (51)	3050 (54.5)	3950 (59)	4240 (61)
130	1910 (45.5)	2270 (47.5)	2560 (48.5)	2530 (52.5)	3370 (57)	3940 (59)
135	1430 (43.5)	1760 (45)	2020 (46)	2060 (50.5)	2850 (55)	3340 (57)
140	—	1280 (43)	1520 (43.5)	1630 (48.5)	2360 (52.5)	2790 (55)
145	—	—	1060 (40.5)	1220 (46.5)	1900 (50.5)	2280 (53)
150	—	—	—	—	1480 (48.5)	1800 (50.5)
155	—	—	—	—	1090 (46.5)	1360 (48)
Min. boom angle for indicated length (no load)	41°	40°	39°	45°	45°	46°
Max. boom length at 0° boom angle (no load)	97 ft			97 ft		

- 33 ft and 56 ft folding boom extension lengths may be used for single line lifting service only.
- For main boom lengths less than 154.3 ft with the boom extension erected, the rated loads are determined by boom angle. Use only the column that corresponds to the boom extension length and offset for which the machine is set up. For boom angles not shown, use rating of the next lower boom angle.
- WARNING: Operation of this machine with heavier loads than the capacities listed is strictly prohibited. Machine tipping with boom extension occurs rapidly and without advance warning.
- Boom angle is the angle above or below horizontal of the longitudinal axis of the boom base section after lifting rated load.
- Capacities listed are with outriggers properly extended and vertical jacks set only.
- When lifting over the main boom nose with 33 ft or 56 ft extension erected, the outriggers must be fully extended.

NOTE: () Boom angles are in degrees.

*This capacity is based on maximum obtainable boom angle.

80081438

THIS CHART IS ONLY A GUIDE AND SHOULD NOT BE USED TO OPERATE THE CRANE.

The individual crane's load chart, operating instructions and other instructional plates must be read and understood prior to operating the crane

Working range

Working range diagram with bi-fold extension and insert

(Boom deflection not shown)

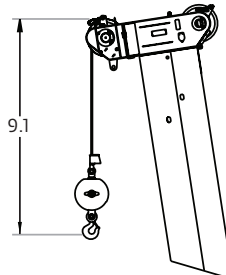
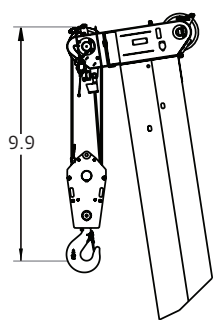
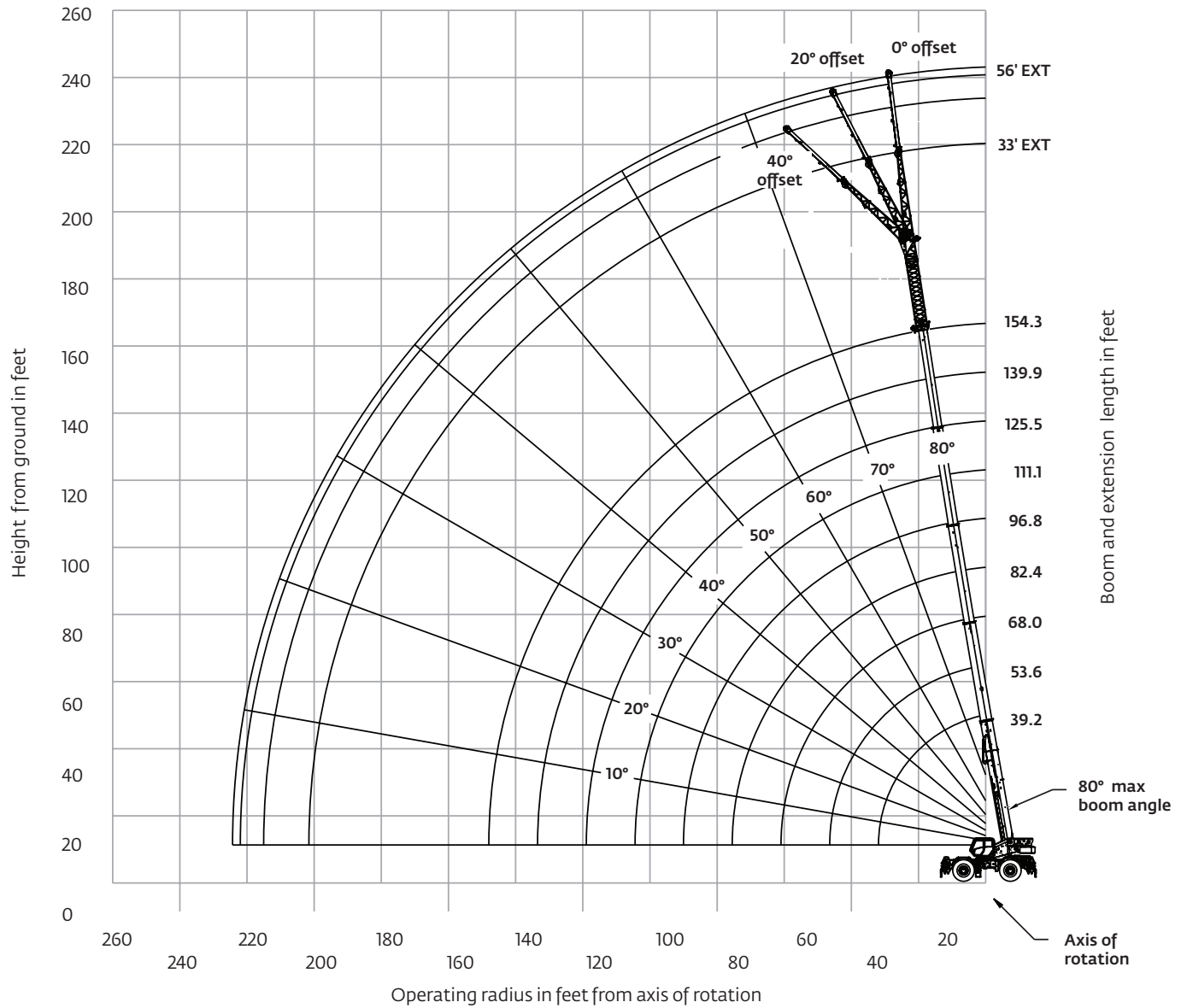

Dimensions are for the largest Grove furnished hook block and overhaul ball, with anti-two block activated.

*THIS CHART IS ONLY A GUIDE AND SHOULD NOT BE USED TO OPERATE THE CRANE.
The individual crane's load chart, operating instructions and other instructional plates must be read and understood prior to operating the crane*

Load chart

Manual extension

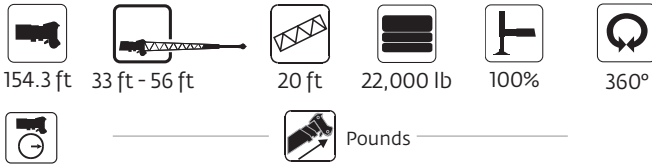

Feet	76 ft length (56 ft ext + 20 ft insert)		
	0° offset	20° offset	40° offset
40	*6190 (80)	—	—
45	6190 (79.5)	—	—
50	6190 (78.5)	—	—
55	6190 (77.5)	—	—
60	6190 (76)	*6000 (80)	—
65	6190 (75)	6000 (79.5)	—
70	6190 (74)	5940 (78)	—
75	6190 (72.5)	5760 (77)	4800 (80)
80	6190 (71.5)	5580 (75.5)	4800 (78.5)
85	6190 (70)	5420 (74.5)	4800 (77.5)
90	6190 (69)	5260 (73)	4740 (76)
95	6190 (68)	5130 (72)	4670 (74.5)
100	6090 (66.5)	5000 (70.5)	4610 (73)
105	5830 (65)	4880 (69.5)	4540 (71.5)
110	5100 (64)	4760 (68)	4480 (70.5)
115	4440 (62.5)	4650 (66.5)	4430 (69)
120	3840 (61)	4540 (65)	4380 (67.5)
125	3290 (59.5)	4150 (63.5)	4330 (66)
130	2780 (58)	3580 (61.5)	4220 (64)
135	2320 (56)	3060 (60)	3630 (62.5)
140	1900 (54.5)	2570 (58)	3080 (60.5)
145	1500 (52.5)	2130 (56)	2580 (58.5)
150	1140 (51)	1710 (54.5)	2110 (56.5)
155	—	1320 (52.5)	1680 (54.5)
160	—	—	1270 (52.5)
Min. boom angle for indicated length (no load)	50°	51°	51°
Max. boom length at 0° boom angle (no load)	82 ft		

1. The 56 ft folding boom extension length may be used for single line lifting service only.
2. For main boom lengths less than 154.3 ft with the boom extension erected, the rated loads are determined by boom angle. Use only the column that corresponds to the boom extension length and offset for which the machine is set up. For boom angles not shown, use rating of the next lower boom angle.
3. **WARNING:** Operation of this machine with heavier loads than the capacities listed is strictly prohibited. Machine tipping with boom extension occurs rapidly and without advance warning.
4. Boom angle is the angle above or below horizontal of the longitudinal axis of the boom base section after lifting rated load.
5. Capacities listed are with outriggers properly extended and vertical jacks set only.
6. When lifting over the main boom nose with the 56 ft extension erected and 20 ft insert, the outriggers must be fully extended.

80081445

NOTE: () Boom angles are in degrees.

*This capacity is based on maximum obtainable boom angle.

THIS CHART IS ONLY A GUIDE AND SHOULD NOT BE USED TO OPERATE THE CRANE.

The individual crane's load chart, operating instructions and other instructional plates must be read and understood prior to operating the crane

Load chart

Hydraulic extension



154.3 ft



33 ft - 56 ft
Fixed offset
angle



22,000 lb



100%



360°



Pounds

Radius in Feet	33 ft LENGTH			56 ft LENGTH		
	0° OFFSET	20° OFFSET	40° OFFSET	0° OFFSET	20° OFFSET	40° OFFSET
30	*13,900 (80)					
35	13,900 (79.5)			*7960 (80)		
40	13,900 (78)	*13,600 (80)		7960 (79)		
45	13,900 (76.5)	13,600 (79.5)		7960 (78)		
50	13,900 (75)	13,600 (78)	11,750 (80)	7960 (76.5)		
55	13,900 (73.5)	13,600 (76.5)	11,600 (78.5)	7960 (75.5)	6700 (80)	
60	13,900 (72)	13,550 (75)	11,450 (76.5)	7960 (74)	6450 (79)	
65	13,900 (70.5)	13,300 (73)	11,300 (75)	7960 (72.5)	6240 (77.5)	*5000 (80)
70	13,900 (69)	13,000 (71.5)	11,150 (73.5)	7600 (71.5)	6040 (76)	5000 (79.5)
75	12,100 (67.5)	12,750 (70)	11,050 (71.5)	7190 (70)	5850 (74.5)	4900 (78)
80	10,500 (66)	11,500 (68.5)	10,950 (70)	6780 (68.5)	5660 (73)	4810 (76.5)
85	9150 (64.5)	10,050 (66.5)	10,750 (68)	6450 (67.5)	5500 (72)	4730 (74.5)
90	7930 (62.5)	8750 (64.5)	9370 (66.5)	6120 (66)	5350 (70.5)	4650 (73)
95	6870 (60.5)	7600 (63)	8170 (64.5)	5860 (64.5)	5200 (69)	4580 (71.5)
100	5920 (58.5)	6580 (61)	7100 (62.5)	5600 (63)	5050 (67.5)	4510 (69.5)
105	5070 (56.5)	5670 (58.5)	6140 (60.5)	5360 (61.5)	4920 (66)	4450 (68)
110	4310 (54.5)	4860 (56.5)	5280 (58)	4900 (60)	4800 (64)	4390 (66)
115	3620 (52.5)	4120 (54.5)	4500 (56)	4220 (58.5)	4690 (62.5)	4340 (64.5)
120	3000 (50)	3450 (52.5)	3800 (53.5)	3610 (56.5)	4580 (60.5)	4290 (62.5)
125	2430 (48)	2830 (50)	3150 (51)	3050 (54.5)	3950 (59)	4240 (61)
130	1910 (45.5)	2270 (47.5)	2560 (48.5)	2530 (52.5)	3370 (57)	3940 (59)
135	1430 (43.5)	1760 (45)	2020 (46)	2060 (50.5)	2850 (55)	3340 (57)
140		1280 (43)	1520 (43.5)	1630 (48.5)	2360 (52.5)	2790 (55)
145			1060 (40.5)	1220 (46.5)	1900 (50.5)	2280 (53)
150					1480 (48.5)	1800 (50.5)
155					1090 (46.5)	1360 (48)
Min. boom angle for indicated length (no load)	41°	40°	39°	45°	45°	46°
Max. boom length at 5° boom angle (no load)	97 ft			97 ft		

NOTE: () Boom angles are in degrees.

80092359

*This capacity is based on maximum obtainable boom angle.

THIS CHART IS ONLY A GUIDE AND SHOULD NOT BE USED TO OPERATE THE CRANE.

The individual crane's load chart, operating instructions and other instructional plates must be read and understood prior to operating the crane

- 33 ft and 56 ft boom extension lengths may be used for single line lifting service only.
- WARNING: Lifting with the 33 ft extension base, with the 23 ft extension fly either erected or folded along side of extension base is strictly prohibited.
- Radii listed are for a 154 ft boom with the boom extension erected. For main boom lengths less than 154 ft, the rated loads are determined by the boom angle. Use only the column which corresponds to the boom extension length and offset for which the machine is configured. For boom angles not shown, use the rating of the next lower boom angle.

WARNING: Operation of this machine with heavier loads than the capacities listed is strictly prohibited. Machine tipping with boom extension occurs rapidly and without advance warning.
- Boom angle is the angle above or below horizontal of the longitudinal axis of the boom base section after lifting rated load.
- Capacities listed are with outriggers properly extended and vertical jacks set only.
- When lifting over the main boom nose with the 33 ft or the 56 ft extension erected and 20 ft insert, the outriggers must be fully extended.

Load chart

Hydraulic extension

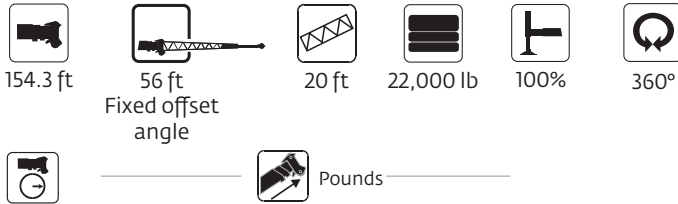

Radius in Feet	76 ft LENGTH		
	0° OFFSET	20° OFFSET	40° OFFSET
40	*6190 (80)		
45	6190 (79.5)		
50	6190 (78.5)		
55	6190 (77.5)		
60	6190 (76)	*6000 (80)	
65	6190 (75)	6000 (79.5)	
70	6190 (74)	5940 (78)	
75	6190 (72.5)	5760 (77)	4800 (80)
80	6190 (71.5)	5580 (75.5)	4800 (78.5)
85	6190 (70)	5420 (74.5)	4800 (77.5)
90	6190 (69)	5260 (73)	4740 (76)
95	6190 (68)	5130 (72)	4670 (74.5)
100	6090 (66.5)	5000 (70.5)	4610 (73)
105	5830 (65)	4880 (69.5)	4540 (71.5)
110	5100 (64)	4760 (68)	4480 (70.5)
115	4440 (62.5)	4650 (66.5)	4430 (69)
120	3840 (61)	4540 (65)	4380 (67.5)
125	3290 (59.5)	4150 (63.5)	4330 (66)
130	2780 (58)	3580 (61.5)	4220 (64)
135	2320 (56)	3060 (60)	3630 (62.5)
140	1900 (54.5)	2570 (58)	3080 (60.5)
145	1500 (52.5)	2130 (56)	2580 (58.5)
150	1140 (51)	1710 (54.5)	2110 (56.5)
155		1320 (52.5)	1680 (54.5)
160			1270 (52.5)
Min. boom angle for indicated length (no load)	50°	51°	51°
Max. boom length at 5° boom angle (no load)	82 ft		

NOTE: () Boom angles are in degrees. 80092360
 *This capacity is based on maximum obtainable boom angle.

1. The 56 ft boom extension lengths may be used for single line lifting service only.
2. Four main boom lengths less than 154 ft with the boom extension erected, the rated loads are determined by boom angle. Use only the column which corresponds to the boom extension length and offset for which the machine is set up. For boom angles not shown, use rating of the next lower boom angle.
3. WARNING: Operation of this machine with heavier loads than the capacities listed is strictly prohibited. Machine tipping with boom extension occurs rapidly and without advance warning.
4. Boom angle is the angle above or below horizontal of the longitudinal axis of the boom base section after lifting rated load.
5. Capacities listed are with outriggers properly extended and vertical jacks set only.
6. When lifting over the main boom nose with the 56 ft extension erected and 20 ft insert, the outriggers must be fully extended.

NOTE: Lifting with 33 ft extension base with 20 ft insert section installed is not permitted.

THIS CHART IS ONLY A GUIDE AND SHOULD NOT BE USED TO OPERATE THE CRANE.
 The individual crane's load chart, operating instructions and other instructional plates must be read and understood prior to operating the crane

Load chart

Hydraulic extension

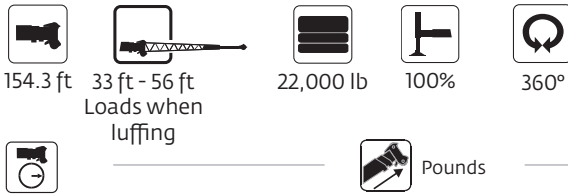

Radius in Feet	33 ft LENGTH		56 ft LENGTH	
	0° - 20° OFFSET	20° - 40° OFFSET	0° - 20° OFFSET	20° - 40° OFFSET
40	13,600			
45	13,600			
50	13,600	11,750		
55	13,600	11,600	6700	
60	13,550	11,350	6450	
65	13,100	11,150	6240	5000
70	12,650	10,950	6040	5000
75	12,100	10,750	5850	4900
80	10,500	10,550	5660	4810
85	9150	10,050	5500	4730
90	7930	8750	5350	4650
95	6870	7600	5200	4580
100	5920	6580	5050	4510
105	5070	5670	4920	4450
110	4310	4860	4800	4390
115	3620	4120	4220	4340
120	3000	3450	3610	4290
125	2430	2830	3050	3950
130	1910	2270	2530	3370
135	1430	1760	2060	2850
140		1280	1630	2360
145			1220	1900
150				1480
155				1090
Min. boom angle for indicated length (no load)	41°	40°	45°	46°
Max. boom length at 5° boom angle (no load)	97 ft		97 ft	

#RCL operating code. Refer to RCL manual for operating instructions.

80092367

- 33 ft and 56 ft boom extension lengths may be used for single line lifting service only.
- WARNING: Lifting with the 33 ft extension base, with the 23 ft extension fly either erected or folded along side of extension base is strictly prohibited.
- Capacities are applicable for a 154 ft main boom length only
WARNING: Operation of this machine with heavier loads than the capacities listed is strictly prohibited. Machine tipping with boom extension occurs rapidly and without advance warning.
- The loads for luffing depend on the angle of the main boom extension and dynamic working pressure of the luffing cylinder for the boom extension
- Capacities listed are with outriggers properly extended and vertical jacks set only.
- When lifting over the main boom nose with the 33 ft or the 56 ft extension erected, the outriggers must be fully extended.

THIS CHART IS ONLY A GUIDE AND SHOULD NOT BE USED TO OPERATE THE CRANE.

The individual crane's load chart, operating instructions and other instructional plates must be read and understood prior to operating the crane

Load chart

Hydraulic extension

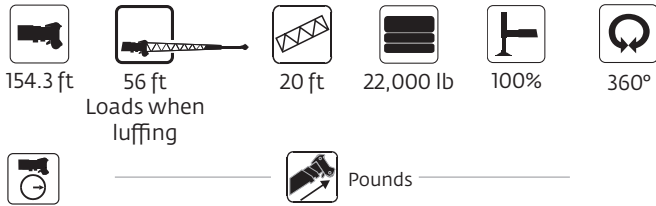

Radius in Feet	76 ft LENGTH	
	0° - 20° OFFSET	20° - 40° OFFSET
60	6000	
65	6000	
70	5940	
75	5760	4800
80	5580	4800
85	5420	4800
90	5260	4740
95	5130	4670
100	5000	4610
105	4880	4540
110	4760	4480
115	4440	4430
120	3840	4380
125	3290	4150
130	2780	3580
135	2320	3060
140	1900	2570
145	1500	2130
150	1140	1710
155		1320
Min. boom angle for indicated length (no load)	51°	51°
Max. boom length at 5° boom angle (no load)	82 ft.	

80092368

1. The 56 ft boom extension lengths may be used for single line lifting service only.

Warning: Lifting with the 33 ft extension base, with the 23 ft extension fly either erected or folded along side of extension base, is strictly prohibited.

3. Capacities are applicable for a 154 ft main boom length only.

WARNING: Operation of this machine with heavier loads than the capacities listed is strictly prohibited. Machine tipping with boom extension occurs rapidly and without advance warning.

4. The loads for luffing depend on the angle of the main boom, angle of the boom extension and dynamic working pressure of the luffing cylinder for the boom extension.
5. Capacities listed are with outriggers properly extended and vertical jacks set only.
6. When lifting over the main boom nose with the 33 ft or 56 ft extension erected, the outriggers must be fully extended.

NOTE: Lifting with 33 ft extension base with 20 ft insert section installed is not permitted.

THIS CHART IS ONLY A GUIDE AND SHOULD NOT BE USED TO OPERATE THE CRANE.

The individual crane's load chart, operating instructions and other instructional plates must be read and understood prior to operating the crane

Load chart

Main boom



Pounds

Feet	Main boom length in feet											
	39.2	53.6	53.6	68.0	68.0	68.0	82.4	82.4	82.4	96.8	96.8	96.8
Tele I	0%	0%	50%	0%	50%	100%	0%	50%	100%	0%	50%	100%
Tele II	0%	17%	0%	33%	17%	0%	50%	33%	17%	67%	50%	33%
Tele III	0%	17%	0%	33%	17%	0%	50%	33%	17%	67%	50%	33%
Tele IV	0%	17%	0%	33%	17%	0%	50%	33%	17%	67%	50%	33%
Mode	A,X,B	A	X,B	A	X	B	A	X	B	A	X	B
8	200,000 (72.5)	—	—	—	—	—	—	—	—	—	—	—
9	188,500 (71)	—	—	—	—	—	—	—	—	—	—	—
10	178,000 (69)	56,100 (75.5)	136,500 (75.5)	55,550 (78.5)	55,500 (78.5)	97,600 (79)	*55,500 (80)	*55,500 (80)	*55,450 (80)	—	—	—
12	159,500 (66)	56,100 (73)	136,500 (73)	55,550 (77)	55,500 (77)	97,600 (77)	55,500 (79.5)	55,500 (79.5)	55,450 (79.5)	—	—	—
15	137,500 (61)	56,100 (69.5)	136,500 (69.5)	55,550 (74)	55,500 (74)	93,750 (74.5)	55,500 (77)	55,500 (77)	55,450 (77.5)	37,850 (79.5)	55,500 (79.5)	55,450 (79.5)
20	106,000 (51.5)	56,100 (63.5)	105,000 (63.5)	55,550 (69.5)	55,500 (69.5)	76,300 (70)	55,500 (73.5)	55,500 (73.5)	55,450 (74)	37,850 (76.5)	55,500 (76.5)	55,450 (76.5)
25	82,200 (40)	56,100 (57)	81,000 (57)	55,550 (65)	55,500 (65)	63,400 (65)	55,500 (70)	55,500 (69.5)	55,450 (70)	37,850 (73.5)	55,500 (73.5)	54,200 (73.5)
30	65,150 (23.5)	56,100 (50)	60,650 (50)	55,550 (60)	55,500 (60)	53,800 (60.5)	55,500 (66)	55,500 (66)	49,150 (66.5)	37,850 (70)	55,500 (70)	46,150 (70.5)
35	—	50,250 (42)	46,150 (42)	51,200 (55)	48,150 (55)	46,350 (55)	49,350 (62)	50,050 (62)	42,300 (62.5)	34,400 (67)	52,100 (67)	39,750 (67)
40	—	39,300 (32.5)	36,350 (32)	40,750 (49.5)	38,200 (49)	36,700 (49.5)	41,700 (58)	39,600 (58)	36,850 (58.5)	30,550 (63.5)	41,650 (63.5)	34,600 (64)
45	—	31,600 (16.5)	28,150 (16.5)	33,350 (43.5)	31,200 (43)	28,950 (43.5)	34,450 (53.5)	32,300 (53.5)	30,100 (54)	27,350 (60)	33,900 (60)	30,400 (60.5)
50	—	—	—	27,700 (36)	25,350 (36)	23,050 (36)	29,050 (49)	26,850 (48.5)	24,400 (49.5)	24,750 (56.5)	28,200 (56.5)	25,550 (57)
55	—	—	—	23,350 (27)	20,600 (27)	18,500 (27)	24,900 (44)	22,650 (43.5)	19,950 (44)	22,500 (53)	23,750 (53)	21,150 (53)
60	—	—	—	19,850 (11)	16,850 (10.5)	14,850 (11)	21,550 (38.5)	19,250 (38)	16,400 (38.5)	20,600 (49)	20,250 (49)	17,650 (49)
65	—	—	—	—	—	—	18,750 (31.5)	16,400 (31.5)	13,450 (32)	18,900 (45)	17,250 (44.5)	14,800 (45)
70	—	—	—	—	—	—	16,350 (23)	14,100 (23)	11,000 (23.5)	16,850 (40)	14,900 (40)	12,400 (40)
75	—	—	—	—	—	—	—	—	—	14,750 (35)	12,850 (34.5)	10,350 (35)
80	—	—	—	—	—	—	—	—	—	13,000 (28.5)	11,100 (28.5)	8590 (28.5)
85	—	—	—	—	—	—	—	—	—	11,400 (20.5)	9510 (20)	7070 (20.5)
Minimum boom angle (°) for indicated length (no load)												0
Maximum boom length (ft) at 0° boom angle (no load) – Mode A and X												125.5
Maximum boom length (ft) at 0° boom angle (no load) – Mode B												111.1

*This capacity is based on maximum boom angle

Boom angle	Lifting capacities at 0° boom angle											
	39.2	53.6	53.6	68.0	68.0	68.0	82.4	82.4	82.4	96.8	96.8	96.8
0°	28,350 (31.7)	18,300 (46.1)	16,000 (46.1)	13,100 (60.5)	10,600 (60.5)	8410 (60.5)	9240 (74.8)	7240 (74.8)	5390 (74.8)	6590 (89.2)	4920 (89.2)	3380 (89.2)

NOTE: () Reference radii in feet.

Shaded area indicates optimal lift capacity within boom length sections.

80081384-1

THIS CHART IS ONLY A GUIDE AND SHOULD NOT BE USED TO OPERATE THE CRANE.

The individual crane's load chart, operating instructions and other instructional plates must be read and understood prior to operating the crane

Load chart

Main boom



39.2 ft - 154.3 ft



27,000 lb



100%



360°



Pounds

Feet	Main boom length in feet <i>cont'd</i>									
	111.1	111.1	111.1	125.5	125.5	125.5	139.9	139.9	154.3	
Tele I	0%	50%	100%	0%	50%	100%	50%	100%	100%	
Tele II	83%	67%	50%	100%	83%	67%	100%	83%	100%	
Tele III	83%	67%	50%	100%	83%	67%	100%	83%	100%	
Tele IV	83%	67%	50%	100%	83%	67%	100%	83%	100%	
Mode	A	X	B	A	X	B	A, X	B	A, X, B	
15	*26,350 (80)	*37,750 (80)	*54,500 (80)	—	—	—	—	—	—	
20	26,350 (78.5)	37,750 (78.5)	54,500 (78.5)	21,650 (80)	26,300 (80)	*37,700 (80)	*21,600 (80)	*26,250 (80)	—	
25	26,350 (76)	37,750 (76)	50,600 (76)	21,650 (78)	26,300 (78)	37,700 (78)	21,600 (79.5)	26,250 (79.5)	*21,550 (79.5)	
30	26,350 (73)	37,750 (73.5)	43,800 (73.5)	21,650 (75.5)	26,300 (75.5)	37,700 (75.5)	21,600 (77.5)	26,250 (77.5)	21,550 (79)	
35	26,350 (70.5)	37,750 (70.5)	37,950 (70.5)	21,650 (73)	26,300 (73)	36,300 (73)	21,600 (75)	26,250 (75.5)	21,550 (77)	
40	26,350 (67.5)	34,300 (68)	33,050 (67.5)	21,650 (70.5)	26,300 (70.5)	31,900 (70.5)	21,600 (73)	26,250 (73)	21,550 (75)	
45	24,400 (65)	30,950 (65)	29,100 (65)	21,650 (68)	26,300 (68)	28,100 (68)	21,600 (71)	26,250 (71)	21,550 (73)	
50	22,000 (62)	28,100 (62)	25,750 (62)	20,050 (65.5)	24,550 (65.5)	24,900 (66)	21,600 (68.5)	24,200 (69)	21,550 (71)	
55	19,900 (59)	24,850 (59)	22,300 (59)	18,100 (63)	22,350 (63)	22,200 (63.5)	20,050 (66.5)	21,600 (66.5)	21,150 (69)	
60	18,150 (56)	21,200 (56)	18,800 (56)	16,450 (60.5)	20,500 (60.5)	19,400 (60.5)	18,300 (64)	19,350 (64.5)	18,950 (67.5)	
65	16,600 (52.5)	18,150 (52.5)	15,950 (52.5)	15,000 (58)	18,450 (58)	16,550 (58)	16,750 (62)	17,150 (62)	17,050 (65.5)	
70	15,250 (49)	15,700 (49)	13,600 (49)	13,700 (55)	16,000 (55)	14,200 (55)	15,400 (59.5)	14,800 (59.5)	15,350 (63.5)	
75	14,050 (45.5)	13,600 (45.5)	11,650 (45.5)	12,600 (52)	13,950 (52)	12,200 (52)	14,250 (57)	12,800 (57.5)	13,400 (61)	
80	13,000 (41.5)	11,750 (41.5)	9,940 (41.5)	11,600 (49)	12,200 (49)	10,550 (49)	12,600 (54.5)	11,100 (54.5)	11,700 (59)	
85	11,950 (37)	10,150 (37)	8,430 (37)	10,700 (46)	10,650 (45.5)	9,080 (46)	11,100 (52)	9,670 (52)	10,250 (56.5)	
90	10,600 (32)	8,790 (32)	7,110 (32)	9,890 (42.5)	9,350 (42)	7,800 (42.5)	9,820 (49)	8,390 (49.5)	8,980 (54.5)	
95	9,440 (26)	7,560 (26)	5,930 (26)	8,480 (38.5)	7,080 (38.5)	5,600 (38.5)	8,680 (46)	7,260 (46.5)	7,850 (52)	
100	8,340 (18)	6,460 (18)	4,890 (18)	7,870 (34.5)	6,120 (34.5)	4,680 (34.5)	6,730 (43)	5,340 (43.5)	5,960 (49.5)	
105	—	—	—	7870 (29.5)	6120 (29.5)	4680 (29.5)	6730 (39.5)	5340 (40)	5960 (47)	
110	—	—	—	7030 (24)	5260 (24)	3850 (24)	5890 (36)	4510 (36.5)	5160 (44)	
115	—	—	—	6270 (16)	4490 (16)	3100 (16)	5130 (32)	3760 (32.5)	4410 (41)	
120	—	—	—	—	—	—	4440 (27.5)	3080 (28)	3730 (38)	
125	—	—	—	—	—	—	3810 (22)	2460 (22)	3110 (34.5)	
130	—	—	—	—	—	—	3220 (14)	1880 (14)	2540 (30.5)	
135	—	—	—	—	—	—	—	—	2020 (26)	
140	—	—	—	—	—	—	—	—	1520 (20.5)	
145	—	—	—	—	—	—	—	—	1060 (12.5)	
Minimum boom angle (°) for indicated length (no load)							15	13	13	11
Maximum boom length (ft) at 0° boom angle (no load) - Mode A and X									125.5	
Maximum boom length (ft) at 0° boom angle (no load) - Mode B									111.1	

*This capacity is based on maximum boom angle

Boom angle	Lifting capacities at 0° boom angle								
	111.1	111.1	111.1	125.5	125.5	125.5	139.9	139.9	154.3
0°	4680 (103.6)	3230 (103.6)	1910 (103.6)	3230 (118)	1950 (118)	—	—	—	—

NOTE: () Reference radii in feet.

Shaded area indicates optimal lift capacity within boom length sections.

80081384-2

THIS CHART IS ONLY A GUIDE AND SHOULD NOT BE USED TO OPERATE THE CRANE.

The individual crane's load chart, operating instructions and other instructional plates must be read and understood prior to operating the crane

Load chart

Manual extension



154.3 ft



33 ft - 56 ft



27,000 lb



100%



360°



Pounds

Feet	33 ft length			56 ft length		
	0° offset	20° offset	40° offset	0° offset	20° offset	40° offset
30	*13,900 (80)	—	—	—	—	—
35	13,900 (79.5)	—	—	*7960 (80)	—	—
40	13,900 (78)	*13,600 (80)	—	7960 (79)	—	—
45	13,900 (76.5)	13,600 (79.5)	—	7960 (78)	—	—
50	13,900 (75)	13,600 (78)	11,750 (80)	7960 (76.5)	—	—
55	13,900 (73.5)	13,600 (76.5)	11,600 (73.5)	7960 (75.5)	6700 (80)	—
60	13,900 (72)	13,550 (75)	11,450 (76.5)	7960 (74)	6450 (79)	—
65	13,900 (70.5)	13,300 (73)	11,300 (75)	7960 (72.5)	6240 (77.5)	*5000 (80)
70	13,900 (69)	13,000 (71.5)	11,150 (73.5)	7600 (71.5)	6040 (76)	5000 (79.5)
75	13,400 (67.5)	12,750 (70)	11,050 (71.5)	7190 (70)	5850 (74.5)	4900 (78)
80	12,000 (66)	12,450 (68.5)	10,950 (70)	6780 (68.5)	5660 (73)	4810 (76.5)
85	10,500 (64.5)	11,400 (66.5)	10,850 (68)	6450 (67.5)	5500 (72)	4730 (74.5)
90	9220 (62.5)	10,000 (64.5)	10,650 (66.5)	6120 (66)	5350 (70.5)	4650 (73)
95	8070 (60.5)	8810 (63)	9370 (64.5)	5860 (64.5)	5200 (69)	4580 (71.5)
100	7060 (58.5)	7720 (61)	8230 (62.5)	5600 (63)	5050 (67.5)	4510 (69.5)
105	6150 (56.5)	6750 (58.5)	7220 (60.5)	5360 (61.5)	4920 (66)	4450 (68)
110	5330 (54.5)	5880 (56.5)	6300 (58)	5120 (60)	4800 (64)	4390 (66)
115	4600 (52.5)	5090 (54.5)	5480 (56)	4930 (58.5)	4690 (62.5)	4340 (64.5)
120	3930 (50)	4380 (52.5)	4730 (53.5)	4540 (56.5)	4590 (60.5)	4290 (62.5)
125	3320 (48)	3720 (50)	4040 (51)	3940 (54.5)	4490 (59)	4240 (61)
130	2760 (45.5)	3130 (47.5)	3410 (48.5)	3390 (52.5)	4230 (57)	4200 (59)
135	2250 (43.5)	2580 (45)	2840 (46)	2880 (50.5)	3660 (55)	4160 (57)
140	1770 (41)	2070 (43)	2310 (43.5)	2410 (48.5)	3140 (52.5)	3570 (55)
145	1330 (38.5)	1600 (40)	1810 (40.5)	1980 (46.5)	2660 (50.5)	3030 (53)
150	—	1170 (37.5)	—	1580 (44.5)	2210 (48.5)	2530 (50.5)
155	—	—	—	1210 (42.5)	1800 (46.5)	2060 (48)
160	—	—	—	—	1410 (44)	1630 (45.5)
165	—	—	—	—	1050 (42)	—
Min. boom angle for indicated length (no load)	36°	36°	38°	41°	41°	44°
Max. boom length at 0° boom angle (no load)	97 ft			97 ft		

- 33 ft and 56 ft folding boom extension lengths may be used for single line lifting service only.
- For main boom lengths less than 154 ft with the boom extension erected, the rated loads are determined by boom angle. Use only the column that corresponds to the boom extension length and offset for which the machine is set up. For boom angles not shown, use rating of the next lower boom angle.
- WARNING:** Operation of this machine with heavier loads than the capacities listed is strictly prohibited. Machine tipping with boom extension occurs rapidly and without advance warning.
- Boom angle is the angle above or below horizontal of the longitudinal axis of the boom base section after lifting rated load.
- Capacities listed are with outriggers properly extended and vertical jacks set only.
- When lifting over the main boom nose with 33 ft or 56 ft extension erected, the outriggers must be fully extended.

NOTE: () Boom angles are in degrees.

*This capacity is based on maximum obtainable boom angle.

80081443

THIS CHART IS ONLY A GUIDE AND SHOULD NOT BE USED TO OPERATE THE CRANE.

The individual crane's load chart, operating instructions and other instructional plates must be read and understood prior to operating the crane

Load chart

Manual extension

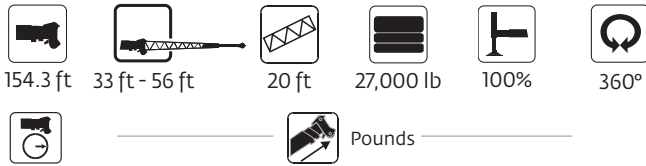

Feet	76 ft length (56' ext + 20' insert)		
	0° offset	20° offset	40° offset
40	*6190 (80)	—	—
45	6190 (79.5)	—	—
50	6190 (78.5)	—	—
55	6190 (77.5)	—	—
60	6190 (76)	*6000 (80)	—
65	6190 (75)	6000 (79.5)	—
70	6190 (74)	5940 (78)	—
75	6190 (72.5)	5760 (77)	4800 (80)
80	6190 (71.5)	5580 (75.5)	4800 (78.5)
85	6190 (70)	5420 (74.5)	4800 (77.5)
90	6190 (69)	5260 (73)	4740 (76)
95	6190 (68)	5130 (72)	4670 (74.5)
100	6090 (66.5)	5000 (70.5)	4610 (73)
105	5830 (65)	4880 (69.5)	4540 (71.5)
110	5580 (64)	4760 (68)	4480 (70.5)
115	5380 (62.5)	4650 (66.5)	4430 (69)
120	4770 (61)	4540 (65)	4380 (67.5)
125	4180 (59.5)	4440 (63.5)	4330 (66)
130	3640 (58)	4350 (61.5)	4280 (64)
135	3140 (56)	3870 (60)	4240 (62.5)
140	2680 (54.5)	3360 (58)	3870 (60.5)
145	2260 (52.5)	2880 (56)	3330 (58.5)
150	1860 (51)	2440 (54.5)	2840 (56.5)
155	1500 (49)	2030 (52.5)	2380 (54.5)
160	1160 (47.5)	1640 (51)	1950 (52.5)
165	—	1280 (49)	1550 (50.5)
170	—	—	1170 (48.5)
Min. boom angle for indicated length (no load)	46°	47°	47°
Max. boom length at 0° boom angle (no load)	82 ft		

1. The 56 ft folding boom extension length may be used for single line lifting service only.
2. For main boom lengths less than 154.3 ft with the boom extension erected, the rated loads are determined by boom angle. Use only the column that corresponds to the boom extension length and offset for which the machine is set up. For boom angles not shown, use rating of the next lower boom angle.
3. **WARNING:** Operation of this machine with heavier loads than the capacities listed is strictly prohibited. Machine tipping with boom extension occurs rapidly and without advance warning.
4. Boom angle is the angle above or below horizontal of the longitudinal axis of the boom base section after lifting rated load.
5. Capacities listed are with outriggers properly extended and vertical jacks set only.
6. When lifting over the main boom nose with the 56 ft extension erected and 20 ft insert, the outriggers must be fully extended.

NOTE: () Boom angles are in degrees.

80081449

*This capacity is based on maximum obtainable boom angle.

THIS CHART IS ONLY A GUIDE AND SHOULD NOT BE USED TO OPERATE THE CRANE.

The individual crane's load chart, operating instructions and other instructional plates must be read and understood prior to operating the crane

Load chart

Hydraulic extension

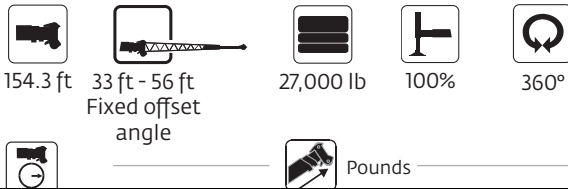

Radius in Feet	33 ft LENGTH			56 ft LENGTH		
	0° OFFSET	20° OFFSET	40° OFFSET	0° OFFSET	20° OFFSET	40° OFFSET
30	⁹ 13,900 (80)					
35	13,900 (79.5)			⁹ 7960 (80)		
40	13,900 (78)	⁹ 13,600 (80)		7960 (79)		
45	13,900 (76.5)	13,600 (79.5)		7960 (78)		
50	13,900 (75)	13,600 (78)	11,750 (80)	7960 (76.5)		
55	13,900 (73.5)	13,600 (76.5)	11,600 (78.5)	7960 (75.5)	6700 (80)	
60	13,900 (72)	13,550 (75)	11,450 (76.5)	7960 (74)	6450 (79)	
65	13,900 (70.5)	13,300 (73)	11,300 (75)	7960 (72.5)	6240 (77.5)	⁹ 5000 (80)
70	13,900 (69)	13,000 (71.5)	11,150 (73.5)	7600 (71.5)	6040 (76)	5000 (79.5)
75	13,400 (67.5)	12,750 (70)	11,050 (71.5)	7190 (70)	5850 (74.5)	4900 (78)
80	12,000 (66)	12,450 (68.5)	10,950 (70)	6780 (68.5)	5660 (73)	4810 (76.5)
85	10,500 (64.5)	11,400 (66.5)	10,850 (68)	6450 (67.5)	5500 (72)	4730 (74.5)
90	9220 (62.5)	10,000 (64.5)	10,650 (66.5)	6120 (66)	5350 (70.5)	4650 (73)
95	8070 (60.5)	8810 (63)	9370 (64.5)	5860 (64.5)	5200 (69)	4580 (71.5)
100	7060 (58.5)	7720 (61)	8230 (62.5)	5600 (63)	5050 (67.5)	4510 (69.5)
105	6150 (56.5)	6750 (58.5)	7220 (60.5)	5360 (61.5)	4920 (66)	4450 (68)
110	5330 (54.5)	5880 (56.5)	6300 (58)	5120 (60)	4800 (64)	4390 (66)
115	4600 (52.5)	5090 (54.5)	5480 (56)	4930 (58.5)	4690 (62.5)	4340 (64.5)
120	3930 (50)	4380 (52.5)	4730 (53.5)	4540 (56.5)	4590 (60.5)	4290 (62.5)
125	3320 (48)	3720 (50)	4040 (51)	3940 (54.5)	4490 (59)	4240 (61)
130	2760 (45.5)	3130 (47.5)	3410 (48.5)	3390 (52.5)	4230 (57)	4200 (59)
135	2250 (43.5)	2580 (45)	2840 (46)	2880 (50.5)	3660 (55)	4160 (57)
140	1770 (41)	2070 (43)	2310 (43.5)	2410 (48.5)	3140 (52.5)	3570 (55)
145	1330 (38.5)	1600 (40)	1810 (40.5)	1980 (46.5)	2660 (50.5)	3030 (53)
150		1170 (37.5)		1580 (44.5)	2210 (48.5)	2530 (50.5)
155				1210 (42.5)	1800 (46.5)	2060 (48)
160					1410 (44)	1630 (45.5)
165					1050 (42)	
Min. boom angle for indicated length (no load)	36°	36°	38°	41°	41°	44°
Max. boom length at 5° boom angle (no load)	97 ft			97 ft		

NOTE: () Boom angles are in degrees.

80092355

⁹This capacity is based on maximum obtainable boom angle.

- 33 ft and 56 ft boom extension lengths may be used for single line lifting service only.
- WARNING: Lifting with the 33 ft extension base, with the 23 ft extension fly either erected or folded along side of extension base is strictly prohibited.
- Radii listed are for a 154 ft boom with the boom extension erected. For main boom lengths less than 140 ft, the rated loads are determined by the boom angle. Use only the column which corresponds to the boom extension length and offset for which the machine is configured. For boom angles not shown, use the rating of the next lower boom angle.

WARNING: Operation of this machine with heavier loads than the capacities listed is strictly prohibited. Machine tipping with boom extension occurs rapidly and without advance warning.
- Boom angle is the angle above or below horizontal of the longitudinal axis of the boom base section after lifting rated load.
- Capacities listed are with outriggers properly extended and vertical jacks set only.
- When lifting over the main boom nose with the 33 ft or the 56 ft extension erected, the outriggers must be fully extended.

THIS CHART IS ONLY A GUIDE AND SHOULD NOT BE USED TO OPERATE THE CRANE.

The individual crane's load chart, operating instructions and other instructional plates must be read and understood prior to operating the crane

Load chart

Hydraulic extension

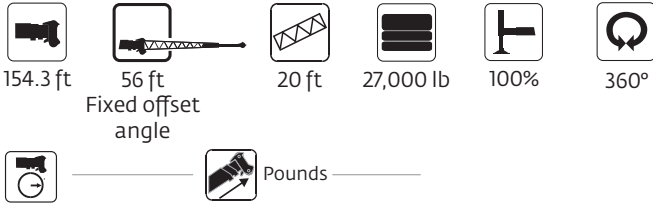

Radius in Feet	76 ft LENGTH		
	0° OFFSET	20° OFFSET	40° OFFSET
40	6190 (80)		
45	6190 (79.5)		
50	6190 (78.5)		
55	6190 (77.5)		
60	6190 (76)	6000 (80)	
65	6190 (75)	6000 (79.5)	
70	6190 (74)	5940 (78)	
75	6190 (72.5)	5760 (77)	4800 (80)
80	6190 (71.5)	5580 (75.5)	4800 (78.5)
85	6190 (70)	5420 (74.5)	4800 (77.5)
90	6190 (69)	5260 (73)	4740 (76)
95	6190 (68)	5130 (72)	4670 (74.5)
100	6090 (66.5)	5000 (70.5)	4610 (73)
105	5830 (65)	4880 (69.5)	4540 (71.5)
110	5580 (64)	4760 (68)	4480 (70.5)
115	5380 (62.5)	4650 (66.5)	4430 (69)
120	4770 (61)	4540 (65)	4380 (67.5)
125	4180 (59.5)	4440 (63.5)	4330 (66)
130	3640 (58)	4350 (61.5)	4280 (64)
135	3140 (56)	3870 (60)	4240 (62.5)
140	2680 (54.5)	3360 (58)	3870 (60.5)
145	2260 (52.5)	2880 (56)	3330 (58.5)
150	1860 (51)	2440 (54.5)	2840 (56.5)
155	1500 (49)	2030 (52.5)	2380 (54.5)
160	1160 (47.5)	1640 (51)	1950 (52.5)
165		1280 (49)	1550 (50.5)
170			1170 (48.5)
Min. boom angle for indicated length (no load)	46°	47°	47°
Max. boom length at 5° boom angle (no load)	82 ft		

1. The 56 ft boom extension lengths may be used for single line lifting service only.
2. Four main boom lengths less than 154 ft with the boom extension erected, the rated loads are determined by boom angle. Use only the column which corresponds to the boom extension length and offset for which the machine is set up. For boom angles not shown, use rating of the next lower boom angle.
3. **WARNING:** Operation of this machine with heavier loads than the capacities listed is strictly prohibited. Machine tipping with boom extension occurs rapidly and without advance warning.
4. Boom angle is the angle above or below horizontal of the longitudinal axis of the boom base section after lifting rated load.
5. Capacities listed are with outriggers properly extended and vertical jacks set only.
6. When lifting over the main boom nose with the 56 ft extension erected and 20 ft insert, the outriggers must be fully extended.

NOTE: Lifting with 33 ft extension base with 20 ft insert section installed is not permitted.

NOTE: () Boom angles are in degrees. 80092356
 *This capacity is based on maximum obtainable boom angle.

THIS CHART IS ONLY A GUIDE AND SHOULD NOT BE USED TO OPERATE THE CRANE.

The individual crane's load chart, operating instructions and other instructional plates must be read and understood prior to operating the crane

Load chart

Hydraulic extension

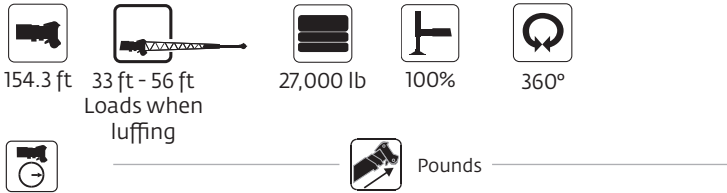

Radius in Feet	33 ft LENGTH		56 ft LENGTH	
	0° - 20° OFFSET	20° - 40° OFFSET	0° - 20° OFFSET	20° - 40° OFFSET
40	13,600			
45	13,600			
50	13,600	11,750		
55	13,600	11,600	6700	
60	13,550	11,350	6450	
65	13,100	11,150	6240	5000
70	12,650	10,950	6040	5000
75	12,250	10,750	5850	4900
80	11,850	10,550	5660	4810
85	10,500	10,400	5500	4730
90	9220	10,000	5350	4650
95	8070	8810	5200	4580
100	7060	7720	5050	4510
105	6150	6750	4920	4450
110	5330	5880	4800	4390
115	4600	5090	4690	4340
120	3930	4380	4540	4290
125	3320	3720	3940	4240
130	2760	3130	3390	4200
135	2250	2580	2880	3660
140	1770	2070	2410	3140
145	1330	1600	1980	2660
150			1580	2210
155			1210	1800
160				1410
Min. boom angle for indicated length (no load)	36°	38°	41°	44°
Max. boom length at 5° boom angle (no load)	97 ft		97 ft	

80092363

- 33 ft and 56 ft boom extension lengths may be used for single line lifting service only.
- WARNING: Lifting with the 33 ft extension base, with the 23 ft extension fly either erected or folded along side of extension base is strictly prohibited.
- Capacities are applicable for a 154 ft main boom length only
WARNING: Operation of this machine with heavier loads than the capacities listed is strictly prohibited. Machine tipping with boom extension occurs rapidly and without advance warning.
- The loads for luffing depend on the angle of the main boom extension and dynamic working pressure of the luffing cylinder for the boom extension
- Capacities listed are with outriggers properly extended and vertical jacks set only.
- When lifting over the main boom nose with the 33 ft or the 56 ft extension erected, the outriggers must be fully extended.

THIS CHART IS ONLY A GUIDE AND SHOULD NOT BE USED TO OPERATE THE CRANE.
The individual crane's load chart, operating instructions and other instructional plates must be read and understood prior to operating the crane

Load chart

Hydraulic extension

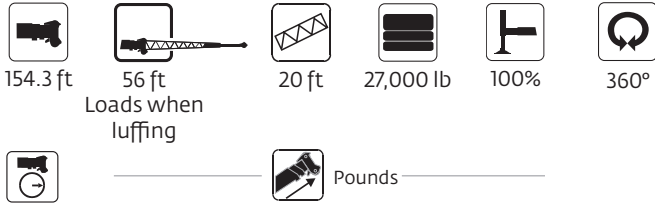

Radius in Feet	76 ft LENGTH	
	0° - 20° OFFSET	20° - 40° OFFSET
60	6000	
65	6000	
70	5940	
75	5760	4800
80	5580	4800
85	5420	4800
90	5260	4740
95	5130	4670
100	5000	4610
105	4880	4540
110	4760	4480
115	4650	4430
120	4540	4380
125	4180	4330
130	3640	4280
135	3140	3870
140	2680	3360
145	2260	2880
150	1860	2440
155	1500	2030
160	1160	1640
165		1280
Min. boom angle for indicated length (no load)	47°	47°
Max. boom length at 5° boom angle (no load)	82 ft	

80092364

1. The 56 ft boom extension lengths may be used for single line lifting service only.

WARNING: Lifting with the 33 ft extension base, with the 23 ft extension fly either erected or folded along side of extension base, is strictly prohibited.

3. Capacities are applicable for a 154 ft main boom length only.

WARNING: Operation of this machine with heavier loads than the capacities listed is strictly prohibited. Machine tipping with boom extension occurs rapidly and without advance warning.

4. The loads for luffing depend on the angle of the main boom, angle of the boom extension and dynamic working pressure of the luffing cylinder for the boom extension.
5. Capacities listed are with outriggers properly extended and vertical jacks set only.
6. When lifting over the main boom nose with the 33 ft or 56 ft extension erected, the outriggers must be fully extended.

NOTE: Lifting with 33 ft extension base with 20 ft insert section installed is not permitted.

THIS CHART IS ONLY A GUIDE AND SHOULD NOT BE USED TO OPERATE THE CRANE.

The individual crane's load chart, operating instructions and other instructional plates must be read and understood prior to operating the crane

Load chart

Pick and carry



39.2 ft - 82.4 ft



27,000 lb
or 22,000 lb



Pick and carry
Up to 1 mph
29.5 x 25 tires



Boom
over front

Boom centered over front

Radius in feet	Main boom length in feet			
	39.2	53.6	68.0	82.4
Tele I	0%	50%	50%	50%
Tele II	0%	0%	17%	33%
Tele III	0%	0%	17%	33%
Tele IV	0%	0%	17%	33%
Mode	X	X	X	X
12	49,450 (66)	42,150 (73)	—	—
15	40,450 (61)	39,050 (69.5)	30,400 (74)	—
20	29,550 (52)	29,100 (63.5)	27,300 (69.5)	24,350 (73.5)
25	21,850 (42)	22,150 (57.5)	23,400 (65)	22,300 (69.5)
30	16,150 (25)	16,850 (50.5)	18,550 (60)	20,250 (66)
35	—	12,800 (43.5)	14,750 (55)	16,350 (62)
40	—	9640 (34.5)	11,700 (50)	13,250 (58)
45	—	7050 (18.5)	9240 (44)	10,700 (53.5)
50	—	—	7110 (37.5)	8460 (49)
55	—	—	5280 (29)	6520 (44)
60	—	—	3780 (13)	4940 (38)
65	—	—	—	3630 (31.5)
70	—	—	—	2520 (23)
Minimum boom angle (°) for indicated length (no load)				32
Maximum boom length at 0° boom angle (no load) - X mode				82.4 ft

*This capacity is based on maximum boom angle

Boom angle	Lifting capacities at 0° boom angle			
	39.2	53.6	68.0	82.4
0°	14,550 (31.7)	6540 (46.1)	3650 (60.5)	1600 (74.8)

NOTE: () Reference radii in feet.

80081412

1. Capacities are in pounds and do not exceed 75% of tipping loads as determined by test in accordance with SAE J765.
2. Capacities are applicable to machines equipped with General / Titan 29.5x25 (34 ply) bias ply tires, at 76 psi cold inflation pressure.
3. Capacities are applicable only with machine on firm level surface.
4. On rubber lifting with boom extension not permitted.
5. For pick and carry operation, boom must be centered over front of machine, mechanical swing lock engaged and load restrained from swinging.
6. Axle lockouts must be functioning when lifting on rubber.
7. All lifting depends on proper tire inflation, capacity and condition. Capacities must be reduced for lower tire inflation pressures. See lifting capacity chart for tire used. Damaged tires are hazardous to safe operation of crane.
8. Creep — not over 200 ft of movement in any 30 minute period and not exceeding 1 mph.

THIS CHART IS ONLY A GUIDE AND SHOULD NOT BE USED TO OPERATE THE CRANE.

The individual crane's load chart, operating instructions and other instructional plates must be read and understood prior to operating the crane

Load chart

Stationary



39.2 ft - 82.4 ft



27,000 lb
or 22,000 lb



Stationary



360°

Stationary capacities				
Radius in feet	Main boom length in feet			
	39.2	53.6	68.0	82.4
Tele I	0%	50%	50%	50%
Tele II	0%	0%	17%	33%
Tele III	0%	0%	17%	33%
Tele IV	0%	0%	17%	33%
Mode	X	X	X	X
20	24,050 (52)	21,500 (63.5)	24,050 (69.5)	25,100 (73.5)
25	15,300 (42)	14,150 (57.5)	16,200 (65)	17,450 (69.5)
30	10,150 (25)	9330 (50.5)	11,100 (60)	12,450 (66)
35	—	5870 (43.5)	7640 (55)	8970 (62)
40	—	3290 (34.5)	5070 (50)	6400 (58)
45	—	1270 (18.5)	3100 (44)	4420 (53.5)
50	—	—	1550 (37.5)	2860 (49)
55	—	—	—	1600 (44)
Minimum boom angle (°) for indicated length (no load)		0	36	43
Maximum boom length at 0° boom angle (no load) - X mode	53.6 ft			

*This capacity is based on maximum boom angle

Boom angle	Lifting capacities at 0° boom angle			
	39.2	53.6	68.0	82.4
0°	8860 (31.7)	—	—	—

NOTE: () Reference radii in feet.

80081409

1. Capacities are in pounds and do not exceed 75% of tipping loads as determined by test in accordance with SAE J765.
2. Capacities are applicable to machines equipped with General / Titan 29.5x25 (34 ply) bias ply tires, at 76 psi cold inflation pressure.
3. Capacities are applicable only with machine on firm level surface.
4. On rubber lifting with boom extension not permitted.
5. For pick and carry operation, boom must be centered over front of machine, mechanical swing lock engaged and load restrained from swinging.
6. Axle lockouts must be functioning when lifting on rubber.
7. All lifting depends on proper tire inflation, capacity and condition. Capacities must be reduced for lower tire inflation pressures. See lifting capacity chart for tire used. Damaged tires are hazardous to safe operation of crane.
8. Creep — not over 200 ft of movement in any 30 minute period and not exceeding 1 mph.

THIS CHART IS ONLY A GUIDE AND SHOULD NOT BE USED TO OPERATE THE CRANE.
The individual crane's load chart, operating instructions and other instructional plates must be read and understood prior to operating the crane

Rigging charts

Rigging chart Installation and removal of hydraulic removable CWT on O/R's fully extended			
Radius in feet	Main boom length in feet		
	39.2	53.6	68.0
Tele I	0%	50%	50%
Tele II	0%	0%	17%
Tele III	0%	0%	17%
Tele IV	0%	0%	17%
Mode	X	X	X
8	195,000 (72.5)	—	—
9	183,000 (71)	—	—
10	172,500 (69)	136,500 (75.5)	55,500 (78.5)
12	152,000 (66)	136,500 (73)	55,500 (77)
15	124,500 (61)	123,000 (69.5)	55,500 (74)
20	90,250 (51.5)	89,000 (63.5)	55,500 (69.5)
25	55,600 (40)	52,600 (57)	54,650 (65)
30	37,100 (23.5)	34,950 (50)	36,850 (60)
35	—	24,750 (42)	26,500 (55)
40	—	17,850 (32)	19,800 (49)
45	—	12,750 (16.5)	15,100 (43)
Minimum boom angle (°) for indicated length (no load)			0
Maximum boom length at 0° boom angle (no load) – X mode			68.0

*This capacity is based on maximum boom angle

Boom angle	Lifting capacities at 0° boom angle		
	39.2	53.6	68.0
0°	28,350 (31.7)	11,800 (46.1)	6200 (60.5)

NOTE: () Reference radii in feet.

80081356

Loading and unloading - on rubber (0 lb counterweight)	
Radius in feet	Main boom length in feet
	39.2
Tele I	0%
Tele II	0%
Tele III	0%
Tele IV	0%
Mode	X
12	5400 (66)
15	5400 (61)
20	5400 (52)
25	5400 (42)
30	5400 (25)
Note: () Boom angles are in degrees	
Boom angle	Lifting capacities at 0° boom angle
	39.2
0°	4070 (31.7)

Note: () Reference radii in feet. 80089238

NOTE: For loading and unloading, the boom must be centered over front of machine and mechanical swing lock engaged.

Load handling

Weight reductions for load handling devices	
Auxiliary boom nose	130 lb
Hook blocks and overhaul weights:	
102 USt, 6-sheave	1451 lb+
90 USt, 5-sheave	1369 lb+
66 USt, 5-sheave	1281 lb+
50 USt, 3-sheave	992 lb+
29 USt, single sheave	712 lb+
12 USt, overhaul weight	648 lb+
12 USt, overhaul ball	575 lb+

+Refer to rating plate for actual weight.

Tire inflation - PSI (bar)		
Size (front and rear)	TRA Code	Lifting service, general travel and extended travel
		Static, creep and 2.5 mph (4.0 km/h)
29.5 x 25 (34)	E-3/L-3	76 (5.2)

Line pulls and reeving information			
Hoists	Cable Specs.	Permissible Line Pulls	Nominal Cable Length
Main and Auxiliary	19 mm (3/4 in) 35x7 Class Rotation Resistant (non-rotating) Min. Breaking strength 85,800 lb	17,160 lb*	702 ft
Main and Auxiliary	22 mm K™100 Hoist Rope Min. Breaking strength 84,000 lb	16,800 lb*	722 ft

The approximate weight of 3/4 in wire rope is 1.5 lb/ft.

The approximate weight of 22 mm synthetic rope is 0.21 lb/ft.

*With certain boom and hoist tackle combinations, the allowable line pull may be limited by hoist performance. Refer to Hoist Performance table for lift planning to ensure adequate hoist performance on drum rope layer required.

33 ft - 56 ft folding boom extension		
	Without block or overhaul weight	With 648 lb overhaul weight
*33 ft extension (erected)	3,500 lb	6,000 lb
*56 ft extension (erected)	7,300 lb	11,500 lb
Folding ext. with 20 ft insert		
*56 ft extension (erected)	12,100 lb	17,400 lb

*Reduction of main boom capacities (no deduct required for stowed boom extension)

NOTE: All load handling devices and boom attachments are considered part of the load and suitable allowances MUST BE MADE for their combined weights. Weights are for Grove furnished equipment.

NOTE: When operating at temperatures below -40°F, capacities shall be derated 3.6% of rated load for each degree Fahrenheit below -40°F without shock load.

Hoist performance				
Wire rope layer	Hoist line pulls		Drum capacity (ft)	
	Two speed hoist		Layer	Total
	Low	High		
	Available lb	Available lb		
1	24,100	15,000	111	111
2	22,200	13,800	120	231
3	20,600	12,800	130	361
4	19,200	11,900	139	500
5	18,000	11,200	149	649
6	16,900	10,500	158	807

*Refer to Line Pulls and Reeving Information table for max. lifting capacity of wire rope.

Synthetic rope layer height may vary and may reduce available line pull per layer.

Working area diagram

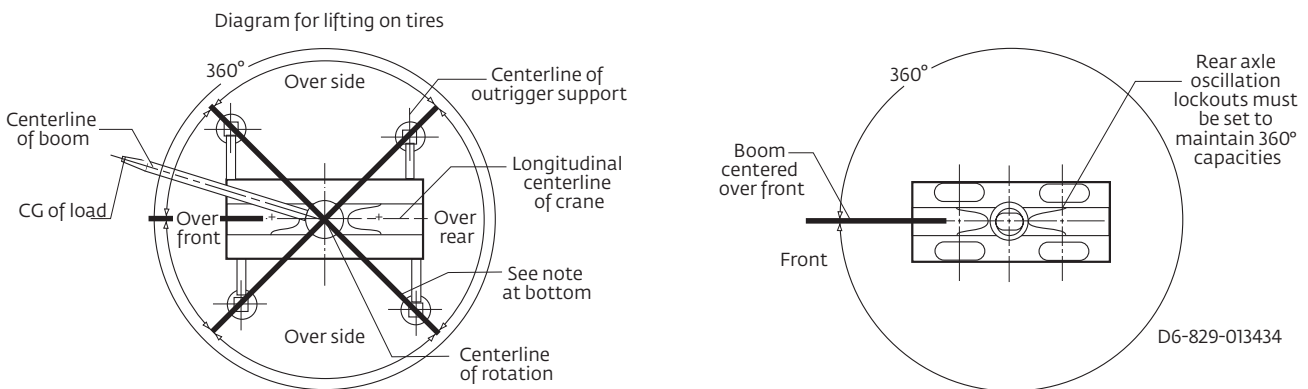

Bold lines determine the limiting position of any load for operation within working areas indicated.

THIS CHART IS ONLY A GUIDE AND SHOULD NOT BE USED TO OPERATE THE CRANE.

The individual crane's load chart, operating instructions and other instructional plates must be read and understood prior to operating the crane

Specifications

Superstructure



Boom

12 m – 47 m (39.2 ft – 154.3 ft) five-section, sequenced synchronized, full-power boom with three operator selectable modes of extension and retraction. Any mode can be enabled or disabled to offer all modes or limited mode depending on user or application usage.
Maximum tip height: 50 m (165 ft)



*Optional manual bi-fold swingaway extension

10 m – 17 m (33 ft – 56 ft) bi-fold lattice swingaway extension. Offsettable at 0°, 20°, and 40°. Stows alongside base boom section. Electric motor assist for stowing and pin alignment.
Maximum tip height: 67 m (220 ft)



*Optional hydraulic bi-fold swingaway extension

10 m – 17 m (33 ft – 56 ft) bi-fold lattice swingaway extension. Hydraulic luffing offset from 0° to 40°. Stows alongside base boom section. Electric motor assist for stowing and pin alignment.
Maximum tip height: 67 m (220 ft)



*Optional lattice extension insert

(1) x 6 m (20 ft) lattice extension insert. Installs between boom nose and either optional extension.
Maximum tip height: 72,9 m (239.4 ft)



Boom nose

Five Nylatron sheaves mounted on heavy-duty tapered roller bearings with removable pin-type guards. Quick-reeve type boom nose. Removable single sheave auxiliary boom nose with removable pin type rope guard.



Boom elevation

One double-acting hydraulic cylinder with integral holding valve provides elevation from -3° to +80°.



Crane Control System (CCS)

“Graphic Display” RCL load moment and anti-two block system with audio-visual warning and control lever lockout. This system provides electronic display of boom angle, boom length, load radius, boom tip height, maximum permissible load, actual load and warning of impending two-block condition. The work area definition system allows the operator to pre-select and define safe working areas. If the crane approaches the pre-set limits, audio-visual warnings aid the operator in avoiding job site obstructions. ECO mode system to control engine R.P.M. to lower noise and improve fuel consumption.



Counterweight

Standard 9979 kg (22,000 lb). Hydraulically installed and removed. Controls located on superstructure.

*Optional 12 247 kg (27,000 lb) one-piece counterweight. Hydraulically installed and removed. Controls located on superstructure.

*Optional 2268 kg (5000 lb) pinned slab increases counterweight to 12 247 kg (27,000 lb) hydraulically installed and removed with standard counterweight.



Cab

Operator-controlled 20° hydraulic tilt, full vision, all steel fabricated with acoustical lining and tinted safety glass throughout. Deluxe seat with headrest, incorporates armrest-mounted electronic programmable single-axis or dual axis controllers and a jog dial for easier data input. Tilt/telescoping steering wheel with various controls incorporated into the steering column. Other standard features include hot water heater, cab circulating air fan, sliding side and opening rear window, sliding skylight with electric wiper and sunscreen, electric windshield wash/wipe, fire extinguisher, seat belt, air conditioning and dual cab mounted work lights.



Swing

Variable speed, planetary swing drive with foot applied multi-disc proportional wet brake. Spring applied, hydraulically released swing brake. Two position mechanical swing lock pin, operated from cab.
Maximum swing speed: 2 rpm



Hoist (main and optional auxiliary hoist)

Planetary reduction driven by axial piston motor. Grooved drum with automatic spring applied multi-disk wet brake. Electronic hoist drum rotation indicator. Third wrap indicator with hoist function cut-out standard. Maximum hoist single line pull:

1st layer: 10 930 kg (24,100 lb)
3rd layer: 9344 kg (20,600 lb)
6th layer: 7666 kg (16,900 lb)

Maximum permissible single line pull:

7784 kg (17,160 lb) with 35 x 7 class rope

Maximum hoist single line speed (no load):

131 m/min (430 ft/min)

Rope construction:

35 x 7 rotation – resistant

Rope diameter:

19 mm (3/4 in)

Rope length:

Main hoist: 214 m (702 ft)

Aux. hoist: 214 m (702 ft)

Maximum usable rope:

241 m (790 ft) 6 layers

* Denotes optional equipment

Specifications

Carrier

Chassis

Parallel box section fabricated from high-strength, low-alloy steel with integral outrigger boxes, front and rear lift, tie-down, and towing lugs.

Outrigger system

Four hydraulic telescoping single stage double box beam outriggers with inverted jack cylinders and integral jack holding valves. Three position settings, 0%, 50%, and fully extended. Polymer outrigger floats. Outrigger monitoring system with outrigger beam position display on RCL screen. Maximum outrigger pad load: 57 290 kg (126,300 lb)

Outrigger controls

Controls and crane leveling indicator located in cab. Extension and retraction are through the CCS system.

Hydraulic system

Two main pumps [2] variable displacement piston and [1] gear with a combined output capacity of 496 L/min (131 gal/min). Maximum operating pressure: 276 bar (4000 psi). Return line in-tank filter with full flow by-pass protection and service indicator. Replaceable cartridge with 4 micron filtration rating per ISO cleanliness level of 17/15/12. Carrier mounted oil cooler with thermostatically controlled hydraulic motor driven fan / air to oil. System pressure test ports.

Engine (Tier 4F)

Cummins QSB6.7L diesel six cylinder, turbo-charged with Cummins Compact Catalyst (CCC) and selective catalytic reduction (SCR) combo muffler, using diesel exhaust fluid (DEF) injection. Meets emissions per U.S. EPA Tier 4F and E.U. Stage IV.

275 hp (205 kW) at 2500 rpm, Maximum torque: 730 lb/ft (990 Nm) at 1500 rpm. Fuel requirements: Maximum of 15 ppm ultra-low sulfur diesel fuel + diesel exhaust fluid (DEF).

NOTE: Required for sale in North America and European Union.

Engine (Tier 3)

Cummins QSB6.7L diesel six cylinder, turbo-charged with 275 hp (205 kW) at 2500 rpm, Maximum torque: 730 lb/ft (990 Nm) at 1500 rpm. Fuel requirements: Maximum of 5000 ppm. Sulfur diesel fuel.

NOTE: Required for sale outside of N.A. and European Union.

Fuel tank capacity

312 L (82 gal)

Transmission

Rangeshift with six forward and six reverse speeds. (Three speeds high and three speeds low). Front axle disconnect for 4 x 2 drive.

Axles

FRONT: Drive / steer with differential and planetary reduction hubs rigid mounted to frame.

REAR: Drive / steer with differential and planetary reduction hubs pivot mounted to frame. Automatic full hydraulic lockouts on rear axle permits 254 mm (10 in) of oscillation only with boom centered over the front.

Brakes

Full hydraulic split (dual) circuit dry disc operating on all wheels with dual calipers. Parking brake is spring applied / hydraulically released on the front axle input shaft.

Steering

Fully independent power steering.
Front: Fully hydraulic steering wheel controlled.
Rear: Fully hydraulic via separate momentary switch provides infinite variations 4 steering modes, front only, rear only, coordinated and crab.
Rear steer not aligned indicator.
Outside 4WS coordinated steer radius: 7,3 m (23.9 ft)
Inside 4WS coordinated steer radius: 4,9 m (16.0 ft)

Tires

29.5 x 25 – 34 bias ply rating

Electrical system

Two 12 V maintenance-free batteries with disconnect.
24 V system / 24 V lighting

Lighting

Full lighting including turn indicators, LED head, tail, brake and hazard warning, and two halogen work lights mounted on cab front.

Maximum Drive Speed

24,1 km/h (15 mph) with 9979 kg (22,000 lb) counterweight
16 km/h (10 mph) with 12 247 kg (27,000 lb) counterweight

Gradeability (theoretical)

104% to drive train stall based on 54 073 kg (119,211 lb) GVW with 29.5 x 25 tires, standard counterweight, auxiliary hoist and manual bi-fold extension.

Miscellaneous standard equipment

Full length steel fenders with full aluminum decking, dual rear view mirrors, hook block tie-down, electronic back-up alarm, front stowage tray, hot water cab heater / defroster, cab air conditioner, hoist mirrors, hourmeter, A/V warning system, combination lift/tie-down/towing lugs, coolant sight level indicator, hoist access platform.

*Optional equipment

- Auxiliary Hoist Package: Includes auxiliary hoist with electronic hoist drum rotation indicator, third wrap indicator with hoist function cut-out, 214 m (702 ft) of 19 mm (¾ in.) of 35 x 7 class rotation resistant wire rope.
- Auxiliary Lighting and Convenience Package: Includes superstructure mounted amber flashing light, dual base boom mounted floodlights, in-cab RCL light bar and rubber mat for storage trough.
- 10 m - 17 m (33 ft – 56 ft) Manual bi-fold swingway extension
- 10 m – 17 m (33 ft – 56 ft) hydraulic luffing extension
- 3 m (10 ft) heavy-duty extension with two sheaves
- 5000 lb (2268 kg) additional counterweight slab
- 360° NYC style mechanical swing lock
- Rear pintle hitch
- Cab-controlled cross axle differential locks (front and rear)
- Wireless wind speed indicator
- Vertical RCL light tower
- -29C / -20F cold weather package
- -40C / -40F arctic weather package
- Emergency stop buttons on each side of carrier
- Second beacon light
- Refinery package (certified spark arrestor + engine air shutdown) (T3 engine only)
- C.E. certificate package
- Russian certificate package
- Synthetic rope for main and / or auxiliary hoist
- CraneSTAR asset management system

** Denotes optional equipment*

Notes

Manitowoc Cranes

Regional headquarters

Americas

Milwaukee, Wisconsin, USA
Tel: +1 414 760 4600

Shady Grove, Pennsylvania, USA
Tel: +1 717 597 8121

Europe and Africa

Dardilly, France - TOWERS
Tel: +33 (0) 4 72 18 20 20

Wilhelmshaven, Germany - MOBILE
Tel: +49 (0) 4421 294 0

APAC

Shanghai, China
Tel: +86 21 6457 0066

Singapore
Tel: +65 6264 1188

Middle East and India

Dubai, UAE
Tel: +971 4 8862677



This document is non-contractual. Constant improvement and engineering progress make it necessary that we reserve the right to make specification, equipment, and price changes without notice. Illustrations shown may include optional equipment and accessories and may not include all standard equipment.