

GRT8090

Product Guide

ANSI B30.5
Imperial 85%



Features

- 80 t (90 USt) capacity
- 12 m – 47 m (39.2 ft – 154.3 ft) five-section full-power boom
- 10 m – 17 m (33 ft – 56 ft) manual offsettable bi-fold lattice swingaway extension
- 9979 kg (22,000 lb) standard counterweight hydraulically installed and removed
- Intuitive, user friendly controls with electronic joysticks and operator customizable function speeds
- Full vision cab with 20° tilt feature

GROVE GRT8090

The GRT8090 was designed after gathering feedback from crane owners and operators to ensure that it is loaded with the features and reliability you demand.

Features

> Cab

The cab is designed with operator comfort and productivity in mind with full-vision design and 20° tilt for improved viewing at high boom angles. The tilt/telescoping steering wheel can be positioned for optimum use.



> Control system

The new Crane Control System (CCS) offers a user-friendly interface, two full graphic displays mounted vertically for easier viewing and a jog dial for easier navigation and data input. The system allows the electronic controllers to be reprogrammed by the operator for specific speed and reaction. Parts commonality across Grove, Manitowoc and Potain product lines enhances operator familiarization and serviceability.



> Boom

Lifting performance is enhanced by the 12 m – 47 m (39.2 ft – 154.3 ft) five-section, full-power MEGAFORM™ boom with sequenced, synchronized extension capability. The boom system offers three operational modes of extension and retraction and one mode specifically for maintenance.



> **CraneSTAR**

CraneSTAR is an exclusive and innovative crane asset management system

that helps improve your profitability and reduce costs by remotely monitoring critical crane data.

Visit www.cranestar.com for more information.

GRT8090 benefits

- > Higher nominal capacity and stronger load charts ensure higher rental rates.
- > Outstanding height and reach provide higher utilization and greater versatility.
- > The GRT8090 transports to the job site quickly and efficiently with a weight under 42 323 kg (93,306 lb) after removal of counterweight and boom extension.
- > Counterweight is hydraulically self-removable and installed by the crane.
- > Three operator selectable telescoping modes for flexibility in any application.
- > ECO mode for intelligent power management and decreased fuel consumption.

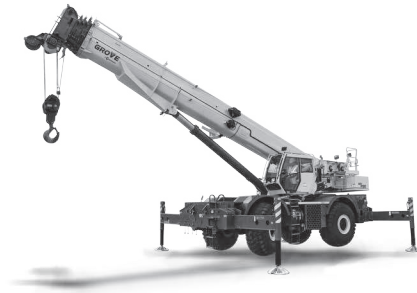

Manitowoc Crane Care when you need it.
The assurance of the world's most advanced crane service and support to get you back to work fast.



Manitowoc Finance helps you get right to work generating profits for your business.
Financial tools that help you capitalize on opportunity with solutions that fit your needs.

Contents

- Dimensions 5
- Weights 6
- Working range 7
- Main boom range / load charts 8
- Working range with bi-fold extension 11
- Extensions range / load charts 12
- Load handling 20
- Specifications..... 21
- Symbols glossary..... 23

Dimensions

Tire Size: 29.5 x 25

A	B	C	D	E	F	G	A	B	C	D	E	F	G
16,3 m (53' 6")	16,8 m (55' 1")	13,6 m (44' 7")	12,9 m (42' 4")	12,5 m (41' 0")	10,1 m (33' 2")	8,8 m (28' 10")	11,8 m (38' 9")	12,2 m (40' 0")	8,4 m (27' 7")	7,7 m (25' 3")	7,3 m (23' 11")	4,9 m (16' 1")	4,6 m (15' 1")
Two-Wheel Steer							Four-Wheel Steer						

Dimensions in mm (in) unless otherwise specified.

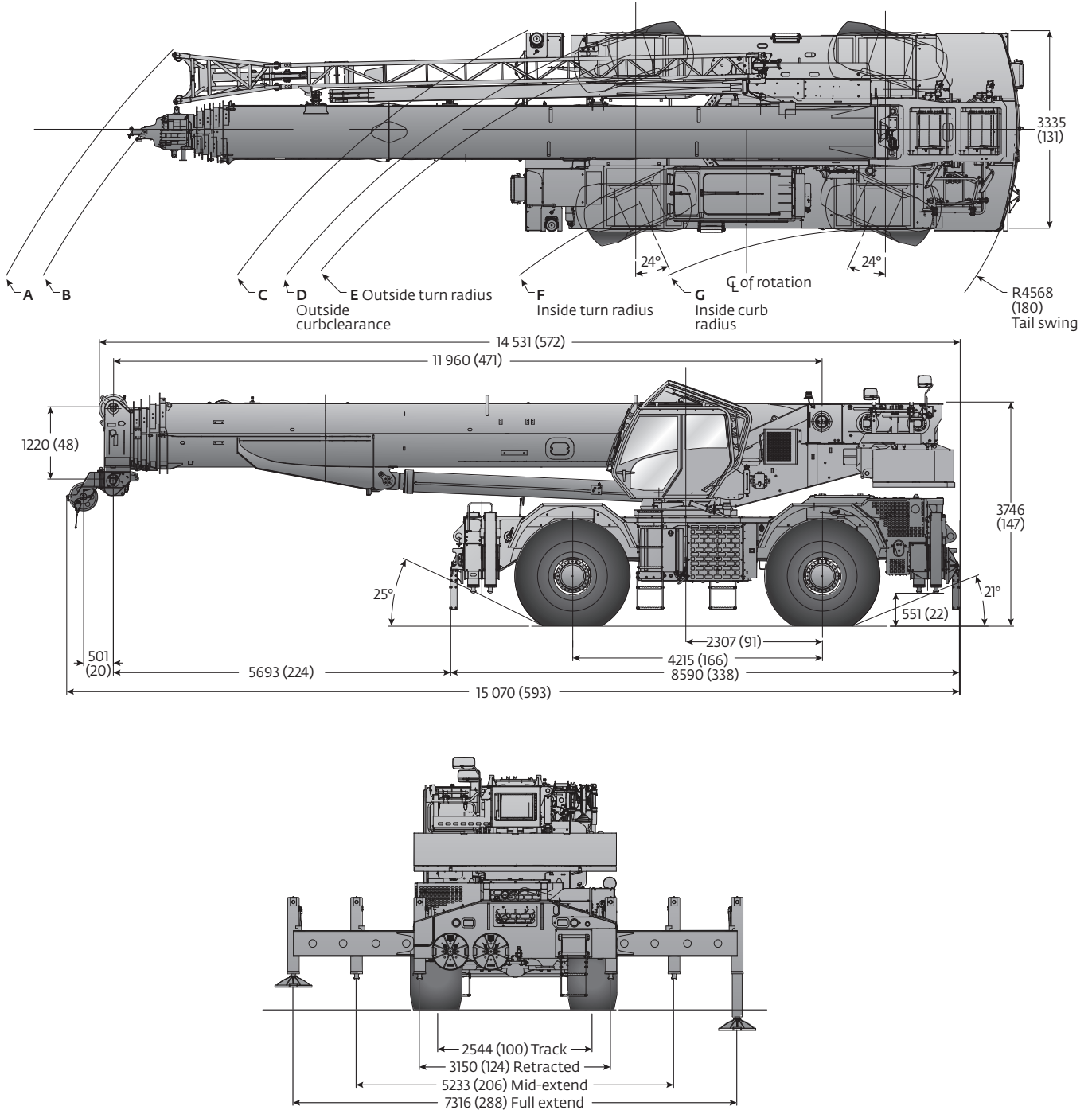

Weights

Weights						
	GVW		Front		Rear	
	kg	lb	kg	lb	kg	lb
Basic Machine (T4F): including 47 m (154.3 ft) main boom, main and auxiliary hoist with 214 m (702 ft) of rope, manual offsettable bi-fold swingaway, 9980 kg (22,000 lb) counterweight, 10,8 t (12 USt) headache ball, and 81,6 t (90 USt) hook block.	53 507	117,961	28 038	61,813	25 468	56,148
Add: 2268 kg (5000 lb) heavy counterweight	2255	4971	-827	-1824	3082	6795
crane weight	55 762	122,932	27 211	59,989	28 550	62,943
Remove: 9980 kg (22,000 lb) counterweight (manual offsettable S/A)	-10 000	-22,046	3735	8234	-13 735	-30,280
crane weight	43 507	95,915	31 773	70,047	11 734	25,868
Remove: 12 247 kg (27,000 lb) counterweight (manual offsettable S/A)	-12 255	-27,017	4562	10,058	-16 817	-37,075
crane weight	43 507	95,915	31 773	70,047	11 734	25,868
Remove: manual bi-fold extension	-1183	-2609	-1848	-4075	665	1466
crane weight	42 324	93,306	29 925	65,972	12 399	27,334
Basic unit as noted above SUB: Hydraulic offsettable bi-fold swingaway	53 826	118,663	28 525	62,885	25 301	55,778
Basic unit with heavy counterweight Hydraulic offsettable bi-fold swingaway	56 080	123,634	27 697	61,060	28 384	62,574
Remove: 9980 kg (22,000 lb) counterweight (Hydraulic offsettable S/A)	-10 000	-22,046	3735	8234	-13 735	-30,280
crane weight	43 825	96,617	32 260	71,119	11 566	25,498
Remove: 12 247 kg (27,000 lb) counterweight (Hydraulic offsettable S/A)	-12 255	-27,017	4562	10,058	-16 817	-37,075
crane weight	43 825	96,617	32 260	71,118	11 566	25,499
Remove: Hydraulic bi-fold extension	-1341	-2956	-2123	-4680	782	1724
crane weight	42 485	93,661	30 136	66,438	12 348	27,223

THIS CHART IS ONLY A GUIDE AND SHOULD NOT BE USED TO OPERATE THE CRANE.

The individual crane's load chart, operating instructions and other instructional plates must be read and understood prior to operating the crane

Courtesy of CraneMarket.com

Working range

Working range diagram with bi-fold extension

(Boom deflection not shown)

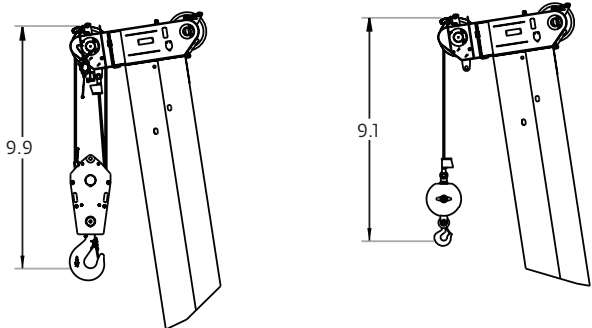
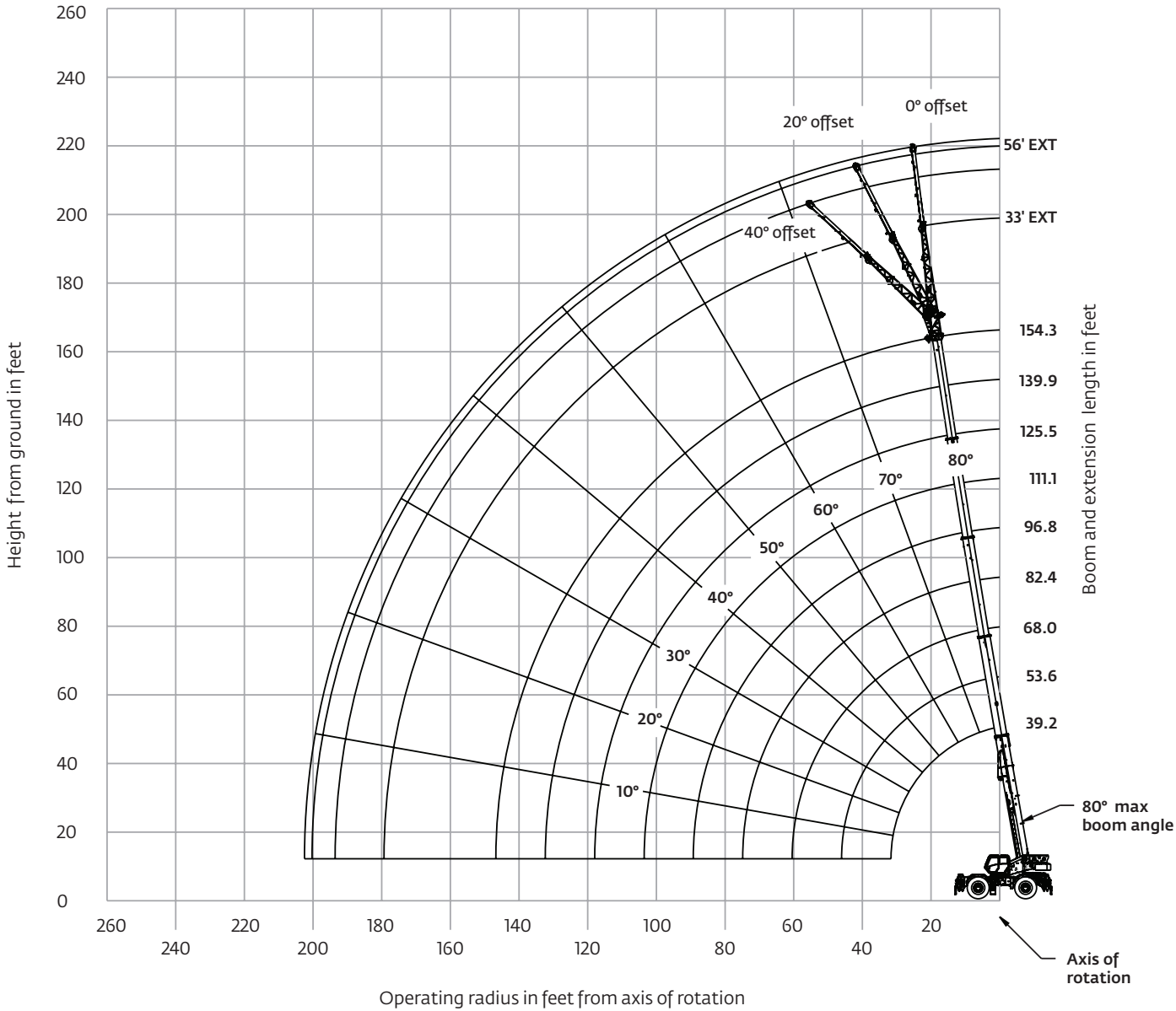

Dimensions are for the largest Grove furnished hook block and overhaul ball, with anti-two block activated.

THIS CHART IS ONLY A GUIDE AND SHOULD NOT BE USED TO OPERATE THE CRANE.

The individual crane's load chart, operating instructions and other instructional plates must be read and understood prior to operating the crane

Load chart



39.2 ft - 154.3 ft



22,000 lb



100%



360°



Pounds

Radius in feet	Main boom length in feet											
	39.2	53.6	53.6	68.0	68.0	68.0	82.4	82.4	82.4	96.8	96.8	96.8
Tele I	0%	0%	50%	0%	50%	100%	0%	50%	100%	0%	50%	100%
Tele II	0%	17%	0%	33%	17%	0%	50%	33%	17%	67%	50%	33%
Tele III	0%	17%	0%	33%	17%	0%	50%	33%	17%	67%	50%	33%
Tele IV	0%	17%	0%	33%	17%	0%	50%	33%	17%	67%	50%	33%
Mode	A,X,B	A	X,B	A	X	B	A	X	B	A	X	B
8	180,000 (72.5)											
9	180,000 (71)											
10	177,000 (69)	56,100 (75.5)	136,500 (75.5)	55,550 (78.5)	55,500 (78.5)	97,600 (79)	*55,500 (80)	*55,500 (80)	*55,450 (80)			
12	158,500 (66)	56,100 (73)	136,500 (73)	55,550 (77)	55,500 (77)	97,600 (77)	55,500 (79.5)	55,500 (79.5)	55,450 (79.5)			
15	135,500 (61)	56,100 (69.5)	134,500 (69.5)	55,550 (74)	55,500 (74)	93,750 (74.5)	55,500 (77)	55,500 (77)	55,450 (77.5)	37,850 (79.5)	55,500 (79.5)	55,450 (79.5)
20	103,000 (51.5)	56,100 (63.5)	102,000 (63.5)	55,550 (69.5)	55,500 (69.5)	76,300 (70)	55,500 (73.5)	55,500 (73.5)	55,450 (74)	37,850 (76.5)	55,500 (76.5)	55,450 (76.5)
25	79,800 (40)	56,100 (57)	78,200 (57)	55,550 (65)	55,500 (65)	63,400 (65)	55,500 (70)	55,500 (69.5)	55,450 (70)	37,850 (73.5)	55,500 (73.5)	54,200 (73.5)
30	59,750 (23.5)	56,100 (50)	55,250 (50)	55,550 (60)	55,500 (60)	53,800 (60.5)	55,500 (66)	55,500 (66)	49,150 (66.5)	37,850 (70)	55,500 (70)	46,150 (70.5)
35		46,000 (42)	41,900 (42)	46,950 (55)	43,900 (55)	43,500 (55)	47,750 (62)	45,800 (62)	42,300 (62.5)	34,400 (67)	47,850 (67)	39,750 (67)
40		35,800 (32.5)	32,650 (32)	37,200 (49.5)	34,700 (49)	33,200 (49.5)	38,200 (58)	36,100 (58)	34,300 (58.5)	30,550 (63.5)	38,100 (63.5)	34,600 (64)
45		28,650 (16.5)	25,000 (16.5)	30,350 (43.5)	28,200 (43)	25,950 (43.5)	31,450 (53.5)	29,300 (53.5)	27,150 (54)	27,350 (60)	30,900 (60)	28,250 (60.5)
50				25,100 (36)	22,600 (36)	20,450 (36)	26,450 (49)	24,200 (48.5)	21,800 (49.5)	24,750 (56.5)	25,550 (56.5)	22,950 (57)
55				21,050 (27)	18,200 (27)	16,200 (27)	22,600 (44)	20,300 (43.5)	17,650 (44)	22,500 (53)	21,450 (53)	18,850 (53)
60				17,800 (11)	14,700 (10.5)	12,800 (11)	19,500 (38.5)	17,150 (38)	14,300 (38.5)	19,950 (49)	18,150 (49)	15,550 (49)
65							16,900 (31.5)	14,550 (31.5)	11,550 (32)	17,350 (45)	15,400 (44.5)	12,900 (45)
70							14,550 (23)	12,350 (23)	9280 (23.5)	15,100 (40)	13,150 (40)	10,700 (40)
75										13,200 (35)	11,250 (34.5)	8770 (35)
80										11,500 (28.5)	9570 (28.5)	7120 (28.5)
85										9990 (20.5)	8080 (20)	5690 (20.5)
Minimum boom angle (°) for indicated length (no load)												0
Maximum boom length (ft) at 0° boom angle (no load) - Mode A and X												125.5
Maximum boom length (ft) at 0° boom angle (no load) - Mode B												111.1

*This capacity is based on maximum boom angle

NOTE: For allowable capacities while operating in 3-second wind gust speeds greater than 30 mph and up to 45 mph, refer to Capacity Reduction Factors for wind speed (3-second gust speed) V(z) greater than 30 mph.

Boom angle	Lifting capacities at 0° boom angle											
	39.2	53.6	53.6	68.0	68.0	68.0	82.4	82.4	82.4	96.8	96.8	96.8
0°	28,350 (31.7)	18,300 (46.1)	16,000 (40.0)	13,100 (60.5)	10,600 (60.5)	8410 (60.5)	9240 (74.8)	7240 (74.8)	5390 (74.8)	6590 (89.2)	4920 (89.2)	3380 (89.2)

NOTE: () Reference radii in feet.

Shaded area indicates optimal lift capacity within boom length sections.

80093667-1

THIS CHART IS ONLY A GUIDE AND SHOULD NOT BE USED TO OPERATE THE CRANE.

The individual crane's load chart, operating instructions and other instructional plates must be read and understood prior to operating the crane

Load chart

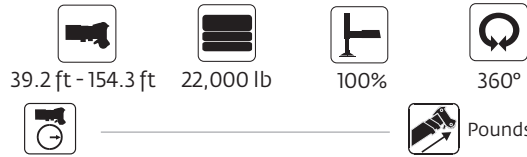

Radius in feet	Main boom length in feet								
	111.1	111.1	111.1						
Tele I	0%	50%	100%	0%	50%	100%	50%	100%	100%
Tele II	83%	67%	50%	100%	83%	67%	100%	83%	100%
Tele III	83%	67%	50%	100%	83%	67%	100%	83%	100%
Tele IV	83%	67%	50%	100%	83%	67%	100%	83%	100%
Mode	A	X	B	A	X	B	A,X	B	A,X,B
15	*26,350 (80)	*37,750 (80)	*54,500 (80)						
20	26,350 (78.5)	37,750 (78.5)	54,500 (78.5)	21,650 (80)	26,300 (80)	*37,700 (80)	*21,600 (80)	*26,250 (80)	
25	26,350 (76)	37,750 (76)	50,600 (76)	21,650 (78)	26,300 (78)	37,700 (78)	21,600 (79.5)	26,250 (79.5)	*21,550 (80)
30	26,350 (73)	37,750 (73.5)	43,800 (73.5)	21,650 (75.5)	26,300 (75.5)	37,700 (75.5)	21,600 (77.5)	26,250 (77.5)	21,550 (79)
35	26,350 (70.5)	37,750 (70.5)	37,950 (70.5)	21,650 (73)	26,300 (73)	36,300 (73)	21,600 (75)	26,250 (75.5)	21,550 (77)
40	26,350 (67.5)	34,300 (68)	33,050 (67.5)	21,650 (70.5)	26,300 (70.5)	31,900 (70.5)	21,600 (73)	26,250 (73)	21,550 (75)
45	24,400 (65)	30,950 (65)	29,100 (65)	21,650 (68)	26,300 (68)	28,100 (68)	21,600 (71)	26,250 (71)	21,550 (73)
50	22,000 (62)	26,900 (62)	24,050 (62)	20,050 (65.5)	24,550 (65.5)	24,650 (66)	21,600 (68.5)	24,200 (69)	21,550 (71)
55	19,900 (59)	22,550 (59)	20,000 (59)	18,100 (63)	22,350 (63)	20,550 (63.5)	20,050 (66.5)	21,150 (66.5)	21,150 (69)
60	18,150 (56)	19,100 (56)	16,750 (56)	16,450 (60.5)	19,300 (60.5)	17,300 (60.5)	18,300 (64)	17,900 (64.5)	18,500 (67.5)
65	16,600 (52.5)	16,300 (52.5)	14,100 (52.5)	15,000 (58)	16,550 (58)	14,700 (58)	16,750 (62)	15,250 (62)	15,850 (65.5)
70	15,250 (49)	13,950 (49)	11,900 (49)	13,700 (55)	14,300 (55)	12,500 (55)	14,600 (59.5)	13,100 (59.5)	13,650 (63.5)
75	13,650 (45.5)	12,000 (45.5)	10,050 (45.5)	12,600 (52)	12,350 (52)	10,650 (52)	12,700 (57)	11,250 (57.5)	11,800 (61)
80	12,000 (41.5)	10,300 (41.5)	8470 (41.5)	11,600 (49)	10,700 (49)	9080 (49)	11,100 (54.5)	9670 (54.5)	10,250 (59)
85	10,550 (37)	8810 (37)	7060 (37)	10,700 (46)	9310 (45.5)	7710 (46)	9750 (52)	8300 (52)	8890 (56.5)
90	9340 (32)	7510 (32)	5820 (32)	9760 (42.5)	8060 (42)	6510 (42.5)	8540 (49)	7110 (49.5)	7700 (54.5)
95	8190 (26)	6350 (26)	4730 (26)	8650 (38.5)	6940 (38.5)	5430 (38.5)	7470 (46)	6060 (46.5)	6640 (52)
100	7150 (18)	5330 (18)	3750 (18)	7670 (34.5)	5940 (34.5)	4460 (34.5)	6520 (43)	5120 (43.5)	5710 (49.5)
105				6800 (29.5)	5040 (29.5)	3600 (29.5)	5650 (39.5)	4260 (40)	4880 (47)
110				6010 (24)	4240 (24)	2830 (24)	4860 (36)	3490 (36.5)	4130 (44)
115				5300 (16)	3510 (16)	2120 (16)	4150 (32)	2790 (32.5)	3430 (41)
120							3510 (27.5)	2150 (28)	2800 (38)
125							2900 (22)	1550 (22)	2220 (34.5)
130							2340 (14)	1000 (14)	1690 (30.5)
135									1180 (26)
Minimum boom angle (°) for indicated length (no load)						15	13	13	25
Maximum boom length (ft) at 0° boom angle (no load) - Mode A and X									125.5
Maximum boom length (ft) at 0° boom angle (no load) - Mode B									111.1

*This capacity is based on maximum boom angle

NOTE: For allowable capacities while operating in 3-second wind gust speeds greater than 30 mph and up to 45 mph, refer to Capacity Reduction Factors for wind speed (3-second gust speed) V(z) greater than 30 mph.

Boom angle	Lifting capacities at 0° boom angle								
	111.1	111.1	111.1	125.5	125.5	125.5	139.9	139.9	154.3
0°	4680 (103.6)	3230 (103.6)	1910 (103.6)	3230 (118)	1950 (118)				

NOTE: () Reference radii in feet. 80093667-2
Shaded area indicates optimal lift capacity within boom length sections.

THIS CHART IS ONLY A GUIDE AND SHOULD NOT BE USED TO OPERATE THE CRANE.

Load chart

(Mode X)

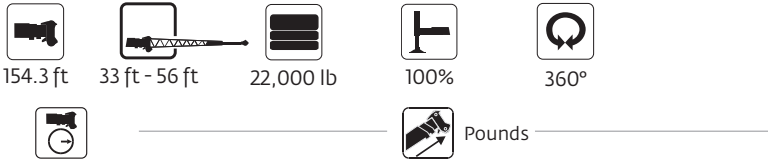

Feet	33 ft length			56 ft length		
	0° offset	20° offset	40° offset	0° offset	20° offset	40° offset
30	*13,900 (80)	—	—	—	—	—
35	13,900 (79.5)	—	—	*7960 (80)	—	—
40	13,900 (78)	*13,600 (80)	—	7960 (79)	—	—
45	13,900 (76.5)	13,600 (79.5)	—	7960 (78)	—	—
50	13,900 (75)	13,600 (78)	11,750 (80)	7960 (76.5)	—	—
55	13,900 (73.5)	13,600 (76.5)	11,600 (78.5)	7960 (75.5)	6700 (80)	—
60	13,900 (72)	13,550 (75)	11,450 (76.5)	7960 (74)	6450 (79)	—
65	13,900 (70.5)	13,300 (73)	11,300 (75)	7960 (72.5)	6240 (77.5)	*5000 (80)
70	13,900 (69)	13,000 (71.5)	11,150 (73.5)	7600 (71.5)	6040 (76)	5000 (79.5)
75	12,100 (67.5)	12,750 (70)	11,050 (71.5)	7190 (70)	5850 (74.5)	4900 (78)
80	10,500 (66)	11,500 (68.5)	10,950 (70)	6780 (68.5)	5660 (73)	4810 (76.5)
85	9150 (64.5)	10,050 (66.5)	10,750 (68)	6450 (67.5)	5500 (72)	4730 (74.5)
90	7930 (62.5)	8750 (64.5)	9370 (66.5)	6120 (66)	5350 (70.5)	4650 (73)
95	6870 (60.5)	7600 (63)	8170 (64.5)	5860 (64.5)	5200 (69)	4580 (71.5)
100	5920 (58.5)	6580 (61)	7100 (62.5)	5600 (63)	5050 (67.5)	4510 (69.5)
105	5070 (56.5)	5670 (58.5)	6140 (60.5)	5360 (61.5)	4920 (66)	4450 (68)
110	4310 (54.5)	4860 (56.5)	5280 (58)	4900 (60)	4800 (64)	4390 (66)
115	3620 (52.5)	4120 (54.5)	4500 (56)	4220 (58.5)	4690 (62.5)	4340 (64.5)
120	3000 (50)	3450 (52.5)	3800 (53.5)	3610 (56.5)	4580 (60.5)	4290 (62.5)
125	2430 (48)	2830 (50)	3150 (51)	3050 (54.5)	3950 (59)	4240 (61)
130	1910 (45.5)	2270 (47.5)	2560 (48.5)	2530 (52.5)	3370 (57)	3940 (59)
135	1430 (43.5)	1760 (45)	2020 (46)	2060 (50.5)	2850 (55)	3340 (57)
140	—	1280 (43)	1520 (43.5)	1630 (48.5)	2360 (52.5)	2790 (55)
145	—	—	1060 (40.5)	1220 (46.5)	1900 (50.5)	2280 (53)
150	—	—	—	—	1480 (48.5)	1800 (50.5)
155	—	—	—	—	1090 (46.5)	1360 (48)
Min. boom angle for indicated length (no load)	41°	40°	39°	45°	45°	46°
Max. boom length at 0° boom angle (no load)	97 ft			97 ft		

- 33 ft and 56 ft folding boom extension lengths may be used for single line lifting service only.
- For main boom lengths less than 154.3 ft with the boom extension erected, the rated loads are determined by boom angle. Use only the column that corresponds to the boom extension length and offset for which the machine is set up. For boom angles not shown, use rating of the next lower boom angle.
- WARNING: Operation of this machine with heavier loads than the capacities listed is strictly prohibited. Machine tipping with boom extension occurs rapidly and without advance warning.
- Boom angle is the angle above or below horizontal of the longitudinal axis of the boom base section after lifting rated load.
- Capacities listed are with outriggers properly extended and vertical jacks set only.
- When lifting over the main boom nose with 33 ft or 56 ft extension erected, the outriggers must be fully extended.

NOTE: () Boom angles are in degrees.

*This capacity is based on maximum obtainable boom angle.

80081438

THIS CHART IS ONLY A GUIDE AND SHOULD NOT BE USED TO OPERATE THE CRANE.

The individual crane's load chart, operating instructions and other instructional plates must be read and understood prior to operating the crane

Courtesy of CraneMarket.com

Working range

Working range diagram with bi-fold extension and insert

(Boom deflection not shown)

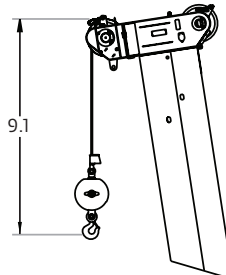
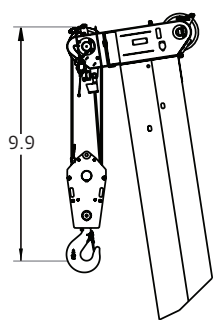
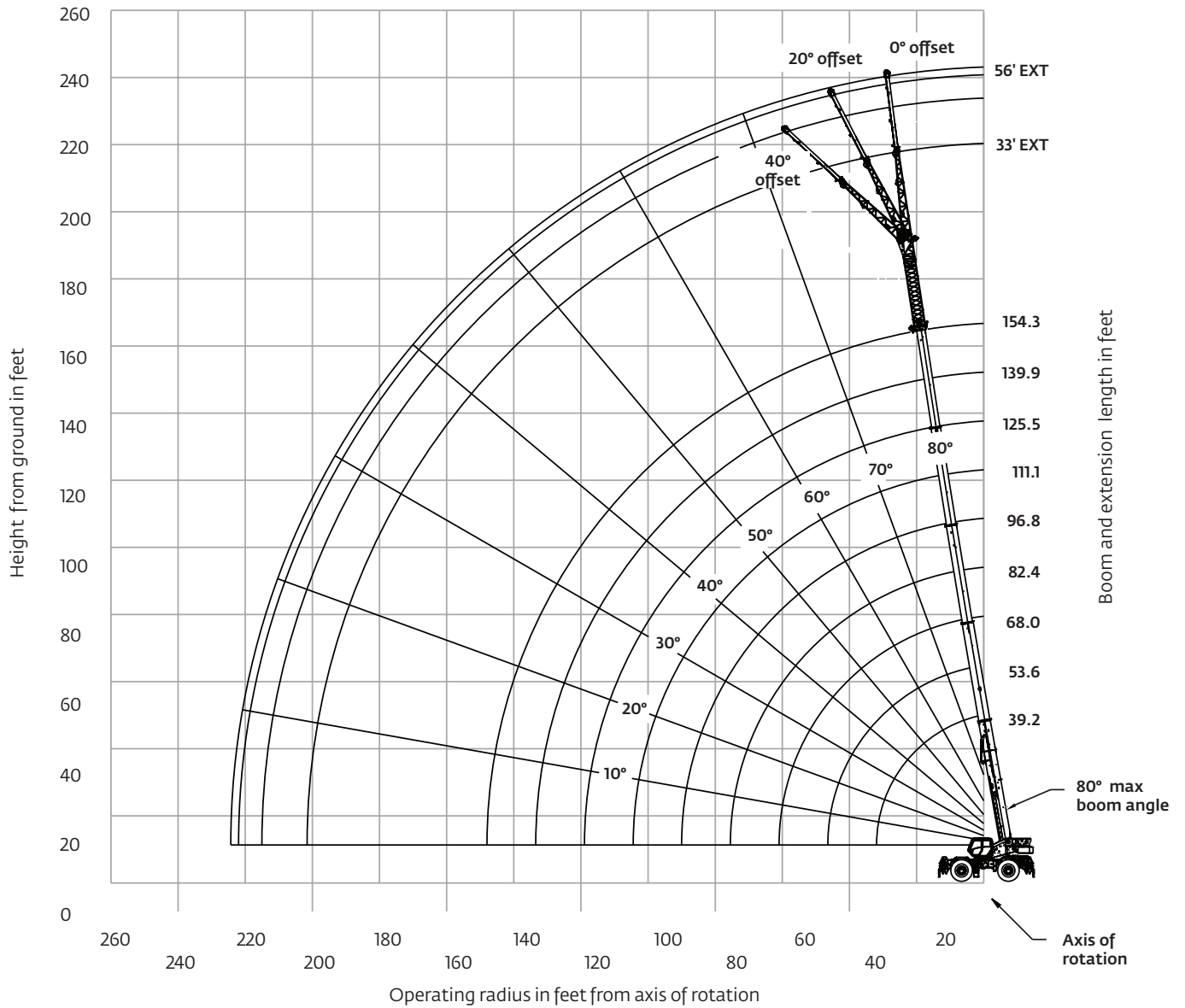

Dimensions are for the largest Grove furnished hook block and overhaul ball, with anti-two block activated.

Load chart

(Mode X)

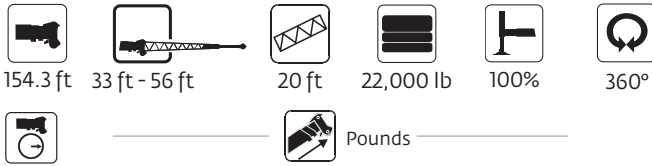

Feet	76 ft length (56 ft ext + 20 ft insert)		
	0° offset	20° offset	40° offset
40	*6190 (80)	—	—
45	6190 (79.5)	—	—
50	6190 (78.5)	—	—
55	6190 (77.5)	—	—
60	6190 (76)	*6000 (80)	—
65	6190 (75)	6000 (79.5)	—
70	6190 (74)	5940 (78)	—
75	6190 (72.5)	5760 (77)	4800 (80)
80	6190 (71.5)	5580 (75.5)	4800 (78.5)
85	6190 (70)	5420 (74.5)	4800 (77.5)
90	6190 (69)	5260 (73)	4740 (76)
95	6190 (68)	5130 (72)	4670 (74.5)
100	6090 (66.5)	5000 (70.5)	4610 (73)
105	5830 (65)	4880 (69.5)	4540 (71.5)
110	5100 (64)	4760 (68)	4480 (70.5)
115	4440 (62.5)	4650 (66.5)	4430 (69)
120	3840 (61)	4540 (65)	4380 (67.5)
125	3290 (59.5)	4150 (63.5)	4330 (66)
130	2780 (58)	3580 (61.5)	4220 (64)
135	2320 (56)	3060 (60)	3630 (62.5)
140	1900 (54.5)	2570 (58)	3080 (60.5)
145	1500 (52.5)	2130 (56)	2580 (58.5)
150	1140 (51)	1710 (54.5)	2110 (56.5)
155	—	1320 (52.5)	1680 (54.5)
160	—	—	1270 (52.5)
Min. boom angle for indicated length (no load)	50°	51°	51°
Max. boom length at 0° boom angle (no load)	82 ft		

1. The 56 ft folding boom extension length may be used for single line lifting service only.
2. For main boom lengths less than 154.3 ft with the boom extension erected, the rated loads are determined by boom angle. Use only the column that corresponds to the boom extension length and offset for which the machine is set up. For boom angles not shown, use rating of the next lower boom angle.
3. **WARNING:** Operation of this machine with heavier loads than the capacities listed is strictly prohibited. Machine tipping with boom extension occurs rapidly and without advance warning.
4. Boom angle is the angle above or below horizontal of the longitudinal axis of the boom base section after lifting rated load.
5. Capacities listed are with outriggers properly extended and vertical jacks set only.
6. When lifting over the main boom nose with the 56 ft extension erected and 20 ft insert, the outriggers must be fully extended.

NOTE: () Boom angles are in degrees.

*This capacity is based on maximum obtainable boom angle.

80081445

THIS CHART IS ONLY A GUIDE AND SHOULD NOT BE USED TO OPERATE THE CRANE.

The individual crane's load chart, operating instructions and other instructional plates must be read and understood prior to operating the crane

Courtesy of CraneMarket.com

Load chart

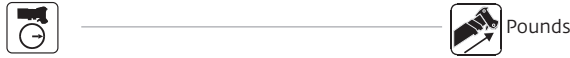

Radius in feet	Main boom length in feet											
	39.2	53.6	53.6	68.0	68.0	68.0	82.4	82.4	82.4	96.8	96.8	96.8
Tele I	0%	0%	50%	0%	50%	100%	0%	50%	100%	0%	50%	100%
Tele II	0%	17%	0%	33%	17%	0%	50%	33%	17%	67%	50%	33%
Tele III	0%	17%	0%	33%	17%	0%	50%	33%	17%	67%	50%	33%
Tele IV	0%	17%	0%	33%	17%	0%	50%	33%	17%	67%	50%	33%
Mode	A,X,B	A	X,B	A	X	B	A	X	B	A	X	B
8	180,000 (72.5)											
9	180,000 (71)											
10	178,000 (69)	56,100 (75.5)	136,500 (75.5)	55,550 (78.5)	55,500 (78.5)	97,600 (79)	*55,500 (80)	*55,500 (80)	*55,450 (80)			
12	159,500 (66)	56,100 (73)	136,500 (73)	55,550 (77)	55,500 (77)	97,600 (77)	55,500 (79.5)	55,500 (79.5)	55,450 (79.5)			
15	137,500 (61)	56,100 (69.5)	136,500 (69.5)	55,550 (74)	55,500 (74)	93,750 (74.5)	55,500 (77)	55,500 (77)	55,450 (77.5)	37,850 (79.5)	55,500 (79.5)	55,450 (79.5)
20	106,000 (51.5)	56,100 (63.5)	105,000 (63.5)	55,550 (69.5)	55,500 (69.5)	76,300 (70)	55,500 (73.5)	55,500 (73.5)	55,450 (74)	37,850 (76.5)	55,500 (76.5)	55,450 (76.5)
25	82,200 (40)	56,100 (57)	81,000 (57)	55,550 (65)	55,500 (65)	63,400 (65)	55,500 (70)	55,500 (69.5)	55,450 (70)	37,850 (73.5)	55,500 (73.5)	54,200 (73.5)
30	65,150 (23.5)	56,100 (50)	60,650 (50)	55,550 (60)	55,500 (60)	53,800 (60.5)	55,500 (66)	55,500 (66)	49,150 (66.5)	37,850 (70)	55,500 (70)	46,150 (70.5)
35		50,250 (42)	46,150 (42)	51,200 (55)	48,150 (55)	46,350 (55)	49,350 (62)	50,050 (62)	42,300 (62.5)	34,400 (67)	52,100 (67)	39,750 (67)
40		39,300 (32.5)	36,350 (32)	40,750 (49.5)	38,200 (49)	36,700 (49.5)	41,700 (58)	39,600 (58)	36,850 (58.5)	30,550 (63.5)	41,650 (63.5)	34,600 (64)
45		31,600 (16.5)	28,150 (16.5)	33,350 (43.5)	31,200 (43)	28,950 (43.5)	34,450 (53.5)	32,300 (53.5)	30,100 (54)	27,350 (60)	33,900 (60)	30,400 (60.5)
50				27,700 (36)	25,350 (36)	23,050 (36)	29,050 (49)	26,850 (48.5)	24,400 (49.5)	24,750 (56.5)	28,200 (56.5)	25,550 (57)
55				23,350 (27)	20,600 (27)	18,500 (27)	24,900 (44)	22,650 (43.5)	19,950 (44)	22,500 (53)	23,750 (53)	21,150 (53)
60				19,850 (11)	16,850 (10.5)	14,850 (11)	21,550 (38.5)	19,250 (38)	16,400 (38.5)	20,600 (49)	20,250 (49)	17,650 (49)
65							18,750 (31.5)	16,400 (31.5)	13,450 (32)	18,900 (45)	17,250 (44.5)	14,800 (45)
70							16,350 (23)	14,100 (23)	11,000 (23.5)	16,850 (40)	14,900 (40)	12,400 (40)
75										14,750 (35)	12,850 (34.5)	10,350 (35)
80										13,000 (28.5)	11,100 (28.5)	8590 (28.5)
85										11,400 (20.5)	9510 (20)	7070 (20.5)
Minimum boom angle (°) for indicated length (no load)												0
Maximum boom length (ft) at 0° boom angle (no load) - Mode A and X												125.5
Maximum boom length (ft) at 0° boom angle (no load) - Mode B												111.1

NOTE: () Boom angles are in degrees.

*This capacity is based on maximum boom angle

NOTE: For allowable capacities while operating in 3-second wind gust speeds greater than 30 mph and up to 45 mph, refer to Capacity Reduction Factors for wind speed (3-second gust speed) V(z) greater than 30 mph.

Boom angle	Lifting capacities at 0° boom angle											
	39.2	53.6	53.6	68.0	68.0	68.0	82.4	82.4	82.4	96.8	96.8	96.8
0°	28,350 (31.7)	18,300 (46.1)	16,000 (46.1)	13,100 (60.5)	10,600 (60.5)	8410 (60.5)	9240 (74.8)	7240 (74.8)	5390 (74.8)	6590 (89.2)	4920 (89.2)	3380 (89.2)

NOTE: () Reference radii in feet.

80093666-1

THIS CHART IS ONLY A GUIDE AND SHOULD NOT BE USED TO OPERATE THE CRANE.

Load chart



39.2 ft - 154.3 ft



27,000 lb



100%



360°



Pounds

Radius in feet	Main boom length in feet								
	111.1	111.1	111.1	125.5	125.5	125.5	139.9	139.9	154.3
Tele I	0%	50%	100%	0%	50%	100%	50%	100%	100%
Tele II	83%	67%	50%	100%	83%	67%	100%	83%	100%
Tele III	83%	67%	50%	100%	83%	67%	100%	83%	100%
Tele IV	83%	67%	50%	100%	83%	67%	100%	83%	100%
Mode	A	X	B	A	X	B	A,X	B	A,X,B
15	26,350 (80)	37,750 (80)	54,500 (80)						
20	26,350 (78.5)	37,750 (78.5)	54,500 (78.5)	21,650 (80)	26,300 (80)	37,700 (80)	21,600 (80)	26,250 (80)	
25	26,350 (76)	37,750 (76)	50,600 (76)	21,650 (78)	26,300 (78)	37,700 (78)	21,600 (79.5)	26,250 (79.5)	21,550 (80)
30	26,350 (73)	37,750 (73.5)	43,800 (73.5)	21,650 (75.5)	26,300 (75.5)	37,700 (75.5)	21,600 (77.5)	26,250 (77.5)	21,550 (79)
35	26,350 (70.5)	37,750 (70.5)	37,950 (70.5)	21,650 (73)	26,300 (73)	36,300 (73)	21,600 (75)	26,250 (75.5)	21,550 (77)
40	26,350 (67.5)	34,300 (68)	33,050 (67.5)	21,650 (70.5)	26,300 (70.5)	31,900 (70.5)	21,600 (73)	26,250 (73)	21,550 (75)
45	24,400 (65)	30,950 (65)	29,100 (65)	21,650 (68)	26,300 (68)	28,100 (68)	21,600 (71)	26,250 (71)	21,550 (73)
50	22,000 (62)	28,100 (62)	25,750 (62)	20,050 (65.5)	24,550 (65.5)	24,900 (66)	21,600 (68.5)	24,200 (69)	21,550 (71)
55	19,900 (59)	24,850 (59)	22,300 (59)	18,100 (63)	22,350 (63)	22,200 (63.5)	20,050 (66.5)	21,600 (66.5)	21,150 (69)
60	18,150 (56)	21,200 (56)	18,800 (56)	16,450 (60.5)	20,500 (60.5)	19,400 (60.5)	18,300 (64)	19,350 (64.5)	18,950 (67.5)
65	16,600 (52.5)	18,150 (52.5)	15,950 (52.5)	15,000 (58)	18,450 (58)	16,550 (58)	16,750 (62)	17,150 (62)	17,050 (65.5)
70	15,250 (49)	15,700 (49)	13,600 (49)	13,700 (55)	16,000 (55)	14,200 (55)	15,400 (59.5)	14,800 (59.5)	15,350 (63.5)
75	14,050 (45.5)	13,600 (45.5)	11,650 (45.5)	12,600 (52)	13,950 (52)	12,200 (52)	14,250 (57)	12,800 (57.5)	13,400 (61)
80	13,000 (41.5)	11,750 (41.5)	9940 (41.5)	11,600 (49)	12,200 (49)	10,550 (49)	12,600 (54.5)	11,100 (54.5)	11,700 (59)
85	11,950 (37)	10,150 (37)	8430 (37)	10,700 (46)	10,650 (45.5)	9080 (46)	11,100 (52)	9670 (52)	10,250 (56.5)
90	10,600 (32)	8790 (32)	710 (32)	9890 (42.5)	9350 (42)	7800 (42.5)	9820 (49)	8390 (49.5)	8980 (54.5)
95	9440 (26)	7560 (26)	5930 (26)	9150 (38.5)	8140 (38.5)	6630 (38.5)	8680 (46)	7260 (46.5)	7850 (52)
100	8340 (18)	6460 (18)	4890 (18)	8480 (34.5)	7080 (34.5)	5600 (34.5)	7660 (43)	6260 (43.5)	6850 (49.5)
105				7870 (29.5)	6120 (29.5)	4680 (29.5)	6730 (39.5)	5340 (40)	5960 (47)
110				7030 (24)	5260 (24)	3850 (24)	5890 (36)	4510 (36.5)	5160 (44)
115				6270 (16)	4490 (16)	3100 (16)	5130 (32)	3760 (32.5)	4410 (41)
120							4440 (27.5)	3080 (28)	3730 (38)
125							3810 (22)	2460 (22)	3110 (34.5)
130							3220 (14)	1880 (14)	2540 (30.5)
135									2020 (26)
140									1520 (20.5)
145									1060 (12.5)
Minimum boom angle (°) for indicated length (no load)						15	13	13	11
Maximum boom length (ft.) at 0° boom angle (no load) - Mode A and X									125.5
Maximum boom length (ft.) at 0° boom angle (no load) - Mode B									111.1

NOTE: () Boom angles are in degrees.

*This capacity is based on maximum boom angle

NOTE: For allowable capacities while operating in 3-second wind gust speeds greater than 30 mph and up to 45 mph, refer to Capacity Reduction Factors for wind speed (3-second gust speed) V(z) greater than 30 mph.

Boom angle	Lifting capacities at 0° boom angle								
	111.1	111.1	111.1	125.5	125.5	125.5	139.9	139.9	154.3
0°	4680 (103.6)	3230 (103.6)	1910 (103.6)	3230 (118)	1950 (118)				

NOTE: () Reference radii in feet.

80093666-2

Shaded area indicates optimal lift capacity within boom length sections.

THIS CHART IS ONLY A GUIDE AND SHOULD NOT BE USED TO OPERATE THE CRANE.

The individual crane's load chart, operating instructions and other instructional plates must be read and understood prior to operating the crane

Courtesy of CraneMarket.com

Load chart

(Mode X)

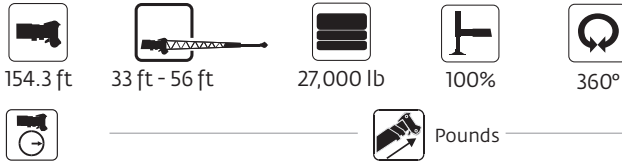

Feet	33 ft length			56 ft length		
	0° offset	20° offset	40° offset	0° offset	20° offset	40° offset
30	*13,900 (80)	—	—	—	—	—
35	13,900 (79.5)	—	—	*7960 (80)	—	—
40	13,900 (78)	*13,600 (80)	—	7960 (79)	—	—
45	13,900 (76.5)	13,600 (79.5)	—	7960 (78)	—	—
50	13,900 (75)	13,600 (78)	11,750 (80)	7960 (76.5)	—	—
55	13,900 (73.5)	13,600 (76.5)	11,600 (78.5)	7960 (75.5)	6700 (80)	—
60	13,900 (72)	13,550 (75)	11,450 (76.5)	7960 (74)	6450 (79)	—
65	13,900 (70.5)	13,300 (73)	11,300 (75)	7960 (72.5)	6240 (77.5)	*5000 (80)
70	13,900 (69)	13,000 (71.5)	11,150 (73.5)	7600 (71.5)	6040 (76)	5000 (79.5)
75	13,400 (67.5)	12,750 (70)	11,050 (71.5)	7190 (70)	5850 (74.5)	4900 (78)
80	12,000 (66)	12,450 (68.5)	10,950 (70)	6780 (68.5)	5660 (73)	4810 (76.5)
85	10,500 (64.5)	11,400 (66.5)	10,850 (68)	6450 (67.5)	5500 (72)	4730 (74.5)
90	9220 (62.5)	10,000 (64.5)	10,650 (66.5)	6120 (66)	5350 (70.5)	4650 (73)
95	8070 (60.5)	8810 (63)	9370 (64.5)	5860 (64.5)	5200 (69)	4580 (71.5)
100	7060 (58.5)	7720 (61)	8230 (62.5)	5600 (63)	5050 (67.5)	4510 (69.5)
105	6150 (56.5)	6750 (58.5)	7220 (60.5)	5360 (61.5)	4920 (66)	4450 (68)
110	5330 (54.5)	5880 (56.5)	6300 (58)	5120 (60)	4800 (64)	4390 (66)
115	4600 (52.5)	5090 (54.5)	5480 (56)	4930 (58.5)	4690 (62.5)	4340 (64.5)
120	3930 (50)	4380 (52.5)	4730 (53.5)	4540 (56.5)	4590 (60.5)	4290 (62.5)
125	3320 (48)	3720 (50)	4040 (51)	3940 (54.5)	4490 (59)	4240 (61)
130	2760 (45.5)	3130 (47.5)	3410 (48.5)	3390 (52.5)	4230 (57)	4200 (59)
135	2250 (43.5)	2580 (45)	2840 (46)	2880 (50.5)	3660 (55)	4160 (57)
140	1770 (41)	2070 (43)	2310 (43.5)	2410 (48.5)	3140 (52.5)	3570 (55)
145	1330 (38.5)	1600 (40)	1810 (40.5)	1980 (46.5)	2660 (50.5)	3030 (53)
150	—	1170 (37.5)	—	1580 (44.5)	2210 (48.5)	2530 (50.5)
155	—	—	—	1210 (42.5)	1800 (46.5)	2060 (48)
160	—	—	—	—	1410 (44)	1630 (45.5)
165	—	—	—	—	1050 (42)	—
Min. boom angle for indicated length (no load)	36°	36°	38°	41°	41°	44°
Max. boom length at 0° boom angle (no load)	97 ft			97 ft		

- 33 ft and 56 ft folding boom extension lengths may be used for single line lifting service only.
- For main boom lengths less than 154 ft with the boom extension erected, the rated loads are determined by boom angle. Use only the column that corresponds to the boom extension length and offset for which the machine is set up. For boom angles not shown, use rating of the next lower boom angle.
- WARNING:** Operation of this machine with heavier loads than the capacities listed is strictly prohibited. Machine tipping with boom extension occurs rapidly and without advance warning.
- Boom angle is the angle above or below horizontal of the longitudinal axis of the boom base section after lifting rated load.
- Capacities listed are with outriggers properly extended and vertical jacks set only.
- When lifting over the main boom nose with 33 ft or 56 ft extension erected, the outriggers must be fully extended.

NOTE: () Boom angles are in degrees.
*This capacity is based on maximum obtainable boom angle.

80081443

THIS CHART IS ONLY A GUIDE AND SHOULD NOT BE USED TO OPERATE THE CRANE.

Load chart

(Mode X)

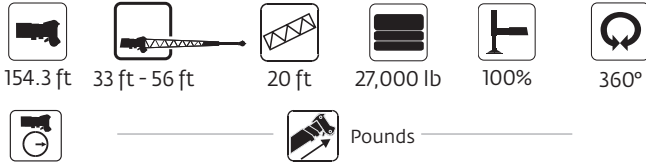

Feet	76 ft length (56' ext + 20' insert)		
	0° offset	20° offset	40° offset
40	*6190 (80)	—	—
45	6190 (79.5)	—	—
50	6190 (78.5)	—	—
55	6190 (77.5)	—	—
60	6190 (76)	*6000 (80)	—
65	6190 (75)	6000 (79.5)	—
70	6190 (74)	5940 (78)	—
75	6190 (72.5)	5760 (77)	4800 (80)
80	6190 (71.5)	5580 (75.5)	4800 (78.5)
85	6190 (70)	5420 (74.5)	4800 (77.5)
90	6190 (69)	5260 (73)	4740 (76)
95	6190 (68)	5130 (72)	4670 (74.5)
100	6090 (66.5)	5000 (70.5)	4610 (73)
105	5830 (65)	4880 (69.5)	4540 (71.5)
110	5580 (64)	4760 (68)	4480 (70.5)
115	5380 (62.5)	4650 (66.5)	4430 (69)
120	4770 (61)	4540 (65)	4380 (67.5)
125	4180 (59.5)	4440 (63.5)	4330 (66)
130	3640 (58)	4350 (61.5)	4280 (64)
135	3140 (56)	3870 (60)	4240 (62.5)
140	2680 (54.5)	3360 (58)	3870 (60.5)
145	2260 (52.5)	2880 (56)	3330 (58.5)
150	1860 (51)	2440 (54.5)	2840 (56.5)
155	1500 (49)	2030 (52.5)	2380 (54.5)
160	1160 (47.5)	1640 (51)	1950 (52.5)
165	—	1280 (49)	1550 (50.5)
170	—	—	1170 (48.5)
Min. boom angle for indicated length (no load)	46°	47°	47°
Max. boom length at 0° boom angle (no load)	82 ft		

1. The 56 ft folding boom extension length may be used for single line lifting service only.
2. For main boom lengths less than 154.3 ft with the boom extension erected, the rated loads are determined by boom angle. Use only the column that corresponds to the boom extension length and offset for which the machine is set up. For boom angles not shown, use rating of the next lower boom angle.
3. **WARNING:** Operation of this machine with heavier loads than the capacities listed is strictly prohibited. Machine tipping with boom extension occurs rapidly and without advance warning.
4. Boom angle is the angle above or below horizontal of the longitudinal axis of the boom base section after lifting rated load.
5. Capacities listed are with outriggers properly extended and vertical jacks set only.
6. When lifting over the main boom nose with the 56 ft extension erected and 20 ft insert, the outriggers must be fully extended.

NOTE: () Boom angles are in degrees.

80081449

*This capacity is based on maximum obtainable boom angle.

THIS CHART IS ONLY A GUIDE AND SHOULD NOT BE USED TO OPERATE THE CRANE.

The individual crane's load chart, operating instructions and other instructional plates must be read and understood prior to operating the crane

Courtesy of CraneMarket.com

Load chart

Stationary



39.2 ft - 82.4 ft



27,000 lb
or 22,000 lb



Stationary



360°

Stationary capacities				
Radius in feet	Main boom length in feet			
	39.2	53.6	68.0	82.4
Tele I	0%	50%	50%	50%
Tele II	0%	0%	17%	33%
Tele III	0%	0%	17%	33%
Tele IV	0%	0%	17%	33%
Mode	X	X	X	X
20	24,050 (52)	21,500 (63.5)	24,050 (69.5)	25,100 (73.5)
25	15,300 (42)	14,150 (57.5)	16,200 (65)	17,450 (69.5)
30	10,150 (25)	9330 (50.5)	11,100 (60)	12,450 (66)
35	—	5870 (43.5)	7640 (55)	8970 (62)
40	—	3290 (34.5)	5070 (50)	6400 (58)
45	—	1270 (18.5)	3100 (44)	4420 (53.5)
50	—	—	1550 (37.5)	2860 (49)
55	—	—	—	1600 (44)
Minimum boom angle (°) for indicated length (no load)		0	36	43
Maximum boom length at 0° boom angle (no load) - X mode	53.6 ft			

*This capacity is based on maximum boom angle

Boom angle	Lifting capacities at 0° boom angle			
	39.2	53.6	68.0	82.4
0°	8860 (31.7)	—	—	—

NOTE: () Reference radii in feet.

80081409

1. Capacities are in pounds and do not exceed 75% of tipping loads as determined by test in accordance with SAE J765.
2. Capacities are applicable to machines equipped with General / Titan 29.5x25 (34 ply) bias ply tires, at 76 psi cold inflation pressure.
3. Capacities are applicable only with machine on firm level surface.
4. On rubber lifting with boom extension not permitted.
5. For pick and carry operation, boom must be centered over front of machine, mechanical swing lock engaged and load restrained from swinging.
6. Axle lockouts must be functioning when lifting on rubber.
7. All lifting depends on proper tire inflation, capacity and condition. Capacities must be reduced for lower tire inflation pressures. See lifting capacity chart for tire used. Damaged tires are hazardous to safe operation of crane.
8. Creep — not over 200 ft of movement in any 30 minute period and not exceeding 1 mph.

Load chart

Pick and carry



39.2 ft - 82.4 ft



27,000 lb
or 22,000 lb



Pick and carry
Up to 1 mph
29.5 x 25 tires



Boom
over front

Boom centered over front				
Radius in feet	Main boom length in feet			
	39.2	53.6	68.0	82.4
Tele I	0%	50%	50%	50%
Tele II	0%	0%	17%	33%
Tele III	0%	0%	17%	33%
Tele IV	0%	0%	17%	33%
Mode	X	X	X	X
12	49,450 (66)	42,150 (73)	—	—
15	40,450 (61)	39,050 (69.5)	30,400 (74)	—
20	29,550 (52)	29,100 (63.5)	27,300 (69.5)	24,350 (73.5)
25	21,850 (42)	22,150 (57.5)	23,400 (65)	22,300 (69.5)
30	16,150 (25)	16,850 (50.5)	18,550 (60)	20,250 (66)
35	—	12,800 (43.5)	14,750 (55)	16,350 (62)
40	—	9640 (34.5)	11,700 (50)	13,250 (58)
45	—	7050 (18.5)	9240 (44)	10,700 (53.5)
50	—	—	7110 (37.5)	8460 (49)
55	—	—	5280 (29)	6520 (44)
60	—	—	3780 (13)	4940 (38)
65	—	—	—	3630 (31.5)
70	—	—	—	2520 (23)
Minimum boom angle (°) for indicated length (no load)				32
Maximum boom length at 0° boom angle (no load) - X mode				82.4 ft

*This capacity is based on maximum boom angle

Boom angle	Lifting capacities at 0° boom angle			
	39.2	53.6	68.0	82.4
0°	14,550 (31.7)	6540 (46.1)	3650 (60.5)	1600 (74.8)

NOTE: () Reference radii in feet.

80081412

1. Capacities are in pounds and do not exceed 75% of tipping loads as determined by test in accordance with SAE J765.
2. Capacities are applicable to machines equipped with General / Titan 29.5x25 (34 ply) bias ply tires, at 76 psi cold inflation pressure.
3. Capacities are applicable only with machine on firm level surface.
4. On rubber lifting with boom extension not permitted.
5. For pick and carry operation, boom must be centered over front of machine, mechanical swing lock engaged and load restrained from swinging.
6. Axle lockouts must be functioning when lifting on rubber.
7. All lifting depends on proper tire inflation, capacity and condition. Capacities must be reduced for lower tire inflation pressures. See lifting capacity chart for tire used. Damaged tires are hazardous to safe operation of crane.
8. Creep — not over 200 ft of movement in any 30 minute period and not exceeding 1 mph.

THIS CHART IS ONLY A GUIDE AND SHOULD NOT BE USED TO OPERATE THE CRANE.

The individual crane's load chart, operating instructions and other instructional plates must be read and understood prior to operating the crane

Courtesy of CraneMarket.com

Rigging charts

Rigging chart Installation and removal of hydraulic removable counterweight on outriggers fully extended (360°)

Radius in feet	Main boom length in feet		
	39.2	53.6	68.0
Tele I	0%	50%	50%
Tele II	0%	0%	17%
Tele III	0%	0%	17%
Tele IV	0%	0%	17%
Mode	X	X	X
8	180,000 (72.5)		
9	180,000 (71)		
10	172,500 (69)	136,500 (75.5)	55,500 (78.5)
12	152,000 (66)	136,500 (73)	55,500 (77)
15	124,500 (61)	123,000 (69.5)	55,500 (74)
20	90,250 (51.5)	89,000 (63.5)	55,500 (69.5)
25	55,600 (40)	52,600 (57)	54,650 (65)
30	37,100 (23.5)	34,950 (50)	36,850 (60)
35		24,750 (42)	26,500 (55)
40		17,850 (32)	19,800 (49)
45		12,750 (16.5)	15,100 (43)
Minimum boom angle (°) for indicated length (no load)			0
Maximum boom length (ft) at 0° boom angle (no load)-X mode			68.0

NOTE: () Boom angles are in degrees.

Boom angle	Lifting capacities at 0° boom angle		
	39.2	53.6	68.0
0°	28,350 (31.7)	11,800 (46.1)	6200 (60.5)

80093668

NOTE: () Reference radii in feet.

Loading and unloading - on rubber (0 lb counterweight)

Radius in feet	Main boom length in feet
Tele I	0%
Tele II	0%
Tele III	0%
Tele IV	0%
Mode	X
12	5400 (66)
15	5400 (61)
20	5400 (52)
25	5400 (42)
30	5400 (25)
Note: () Boom angles are in degrees	
Boom angle	Lifting capacities at 0° boom angle
	39.2
0°	4070 (31.7)

Note: () Reference radii in feet. 80089238

NOTE: For loading and unloading, the boom must be centered over front of machine and mechanical swing lock engaged.

Load handling

Weight reductions for load handling devices	
Auxiliary boom nose	130 lb
Hook blocks and headache balls:	
90 USt, 5-sheave	1327 lb+
65 USt, 5-sheave	1280 lb+
50 USt, 3-sheave	1000 lb+
25 USt, 1-sheave	657 lb+
12 USt overhaul ball	558 lb+

+Refer to rating plate for actual weight.

Tire inflation - PSI (bar)		
Size (front and rear)	TRA Code	Lifting service, general travel and extended travel
		Static, creep and 2.5 mph (4.0 km/h)
29.5 x 25 (34)	E-3	76 (5.2)

Line pulls and reeving information			
Hoists	Cable Specs.	Permissible Line Pulls	Nominal Cable Length
Main and Auxiliary	19 mm (3/4 in) 35x8 Class Rotation Resistant (non-rotating) Min. Breaking strength 85,800 lb	17,160 lb*	702 ft
Main and Auxiliary	22 mm K™100 Hoist Rope Min. Breaking strength 84,000 lb	16,800 lb*	722 ft

The approximate weight of 3/4 in wire rope is 1.5 lb/ft.

The approximate weight of 22 mm synthetic rope is 0.21 lb/ft.

*With certain boom and hoist tackle combinations, the allowable line pull may be limited by hoist performance. Refer to Hoist Performance table for lift planning to ensure adequate hoist performance on drum rope layer required.

33 ft - 56 ft folding boom extension		
	Without block or ball	With 558 lb overhaul ball
*33 ft extension (erected)	3500 lb	5800 lb
*56 ft extension (erected)	7400 lb	11,100 lb
Folding ext. with 20 ft insert		
*56 ft extension (erected)	13,000 lb	17,900 lb

*Reduction of main boom capacities (no deduct required for stowed boom extension)

NOTE: All load handling devices and boom attachments are considered part of the load and suitable allowances MUST BE MADE for their combined weights. Weights are for Grove furnished equipment.

NOTE: When operating at temperatures below -40°F, capacities shall be derated 3.6% of rated load for each degree Fahrenheit below -40°F without shock load.

Hoist performance				
Wire rope layer	Hoist line pulls		Drum capacity (ft)	
	Two speed hoist		Layer	Total
	Low	High		
	Available lb	Available lb		
1	23,468	12,957	108.7	108.7
2	21,553	11,900	118.4	227.1
3	19,927	11,003	128.1	355.2
4	18,530	10,231	137.7	492.9
5	17,315	9560	147.4	640.3
6	16,250	8972	157.1	797.4

*Refer to Line Pulls and Reeving Information table for max. lifting capacity of wire rope.

Synthetic rope layer height may vary and may reduce available line pull per layer.

Working area diagram

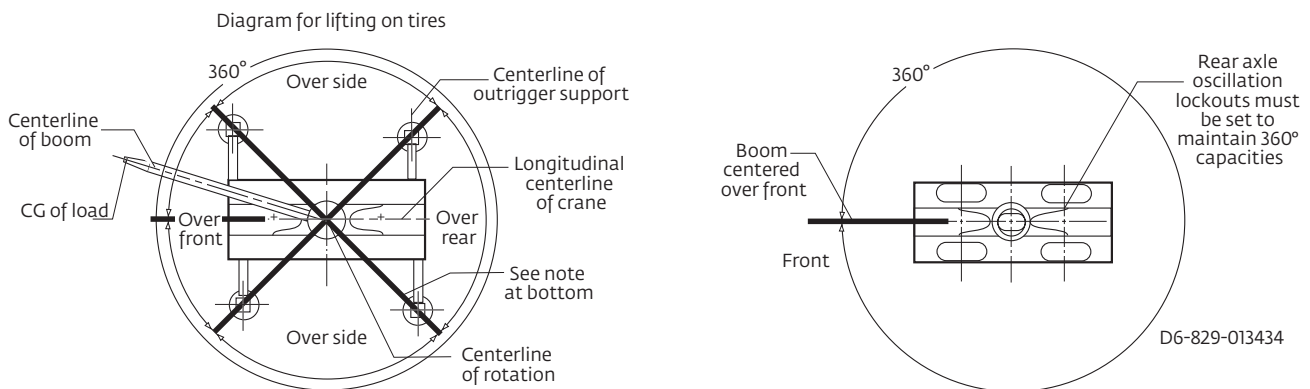

Bold lines determine the limiting position of any load for operation within working areas indicated.

THIS CHART IS ONLY A GUIDE AND SHOULD NOT BE USED TO OPERATE THE CRANE.

The individual crane's load chart, operating instructions and other instructional plates must be read and understood prior to operating the crane

Courtesy of CraneMarket.com

Superstructure



Boom

12 m – 47 m (39.2 ft – 154.3 ft) five-section, sequenced synchronized, full-power boom with three operator selectable modes of extension and retraction. Any mode can be enabled or disabled to offer all modes or limited mode depending on user or application usage.
Maximum tip height: 50 m (165 ft)



*Optional manual bi-fold swingaway extension

10 m – 17 m (33 ft – 56 ft) bi-fold lattice swingaway extension. Offsettable at 0°, 20°, and 40°. Stows alongside base boom section. Electric motor assist for stowing and pin alignment.
Maximum tip height: 67 m (220 ft)



*Optional hydraulic bi-fold swingaway extension

10 m – 17 m (33 ft – 56 ft) bi-fold lattice swingaway extension. Hydraulic luffing offset from 0° to 40°. Stows alongside boom section. Electric motor assist for stowing and pin alignment.
Maximum tip height: 67 m (220 ft)



*Optional lattice extension insert

(1) x 6 m (20 ft) lattice extension insert. Installs between boom nose and either optional extension.
Maximum tip height: 72,9 m (239.4 ft)



Boom nose

Five Nylatron sheaves mounted on heavy-duty tapered roller bearings with removable pin-type guards. Quick-reeve type boom nose. Removable single sheave auxiliary boom nose with removable pin type rope guard.



Boom elevation

One double-acting hydraulic cylinder with integral holding valve provides elevation from -3° to +80°.



Crane Control System (CCS)

“Graphic Display” RCL load moment and anti-two block system with audio-visual warning and control lever lockout. This system provides electronic display of boom angle, boom length, load radius, boom tip height, maximum permissible load, actual load and warning of impending two-block condition. The work area definition system allows the operator to pre-select and define safe working areas. If the crane approaches the pre-set limits, audio-visual warnings aid the operator in avoiding job site obstructions. ECO mode system to control engine R.P.M. to lower noise and improve fuel consumption.



Counterweight

Standard 9979 kg (22,000 lb). Hydraulically installed and removed. Controls located on superstructure.

*Optional 12 247 kg (27,000 lb) one-piece counterweight. Hydraulically installed and removed. Controls located on superstructure.

*Optional 2268 kg (5000 lb) pinned slab increases counterweight to 12 247 kg (27,000 lb) hydraulically installed and removed with standard counterweight.



Cab

Operator-controlled 20° hydraulic tilt, full vision, all steel fabricated with acoustical lining and tinted safety glass throughout. Deluxe seat with headrest, incorporates armrest-mounted electronic programmable single-axis or dual axis controllers and a jog dial for easier data input. Tilt/telescoping steering wheel with various controls incorporated into the steering column. Other standard features include hot water heater, cab circulating air fan, sliding side and opening rear window, sliding skylight with electric wiper and sunscreen, electric windshield wash/wipe, fire extinguisher, seat belt, air conditioning and dual cab mounted work lights.



Swing

Variable speed, planetary swing drive with foot applied multi-disc proportional wet brake. Spring applied, hydraulically released swing brake. Two position mechanical swing lock pin, operated from cab.
Maximum swing speed: 2 rpm



Hoist (main and auxiliary hoist)

Planetary reduction driven by axial piston motor. Grooved drum with automatic spring applied multi-disk wet brake. Electronic hoist drum rotation indicator and hoist drum cable follower. Third wrap indicator with hoist function cut-out standard. Maximum hoist single line pull:

1st layer: 10 645 kg (23,468 lb)

3rd layer: 9039 kg (19,927 lb)

6th layer: 7371 kg (16,250 lb)

Maximum permissible single line pull:

7620 kg (16,800 lb) with 35 x 7 class rope

Maximum hoist single line speed (no load):

148 m/min (487 ft/min)

Rope construction:

35 x 7 rotation – resistant

Rope diameter:

19 mm (3/4 in)

Rope length:

Main hoist: 214 m (702 ft)

Aux. hoist: 214 m (702 ft)

Maximum usable rope:

241 m (790 ft) 6 layers

* Denotes optional equipment

Specifications

Carrier



Chassis

Parallel box section fabricated from high-strength, low-alloy steel with integral outrigger boxes, front and rear lift, tie-down, and towing lugs.



Outrigger system

Four hydraulic telescoping single stage double box beam outriggers with inverted jack cylinders and integral jack holding valves. Three position settings, 0%, 50%, and fully extended. Aluminum fabricated outrigger floats 609,6 mm (24 in) diameter. Outrigger monitoring system with outrigger beam position display on R.C.L. screen. Maximum outrigger pad load: 57 290 kg (126,300 lb)



Outrigger controls

Controls and crane leveling indicator located in cab. Extension and retraction are through the CCS system.



Hydraulic system

Two main pumps [2] variable displacement piston and [1] gear with a combined output capacity of 496 L/min (131 gal/min). Maximum operating pressure: 276 bar (4000 psi) Return line in-tank filter with full flow by-pass protection and service indicator. Replaceable cartridge with 4 micron filtration rating per ISO cleanliness level of 17/15/12. Carrier mounted oil cooler with thermostatically controlled hydraulic motor driven fan / air to oil. System pressure test ports.



Engine (Tier 4F)

Cummins QSB6,7L diesel six cylinder, turbo-charged with Cummins Compact Catalyst (CCC) and selective catalytic reduction (SCR) combo muffler, using diesel exhaust fluid (DEF) injection. Meets emissions per U.S. EPA Tier 4F and E.U. Stage IV.

275 hp (205 kW) at 2500 rpm, Maximum torque: 730 lb/ft (990 Nm) at 1500 rpm. Fuel requirements: Maximum of 15 ppm ultra-low sulfur diesel fuel + diesel exhaust fluid (DEF).

NOTE: Required for sale in North America and European Union.



Engine (Tier 3)

Cummins QSB6,7L diesel six cylinder, turbo-charged with 275 hp (205 kW) at 2500 rpm, Maximum torque: 730 lb/ft (990 Nm) at 1500 rpm. Fuel requirements: Maximum of 5000 ppm. Sulfur diesel fuel.

NOTE: Required for sale outside of N.A. and European Union.



Fuel tank capacity

312 L (82 gal)



Transmission

Rangeshift with six forward and six reverse speeds. (Three speeds high and three speeds low). Front axle disconnect for 4 x 2 drive.



Axles

FRONT: Drive / steer with differential and planetary reduction hubs rigid mounted to frame.

REAR: Drive / steer with differential and planetary reduction hubs pivot mounted to frame. Automatic full hydraulic lockouts on rear axle permits 254 mm (10 in) of oscillation only with boom centered over the front.



Brakes

Full hydraulic split (dual) circuit dry disc operating on all wheels with dual calipers. Parking brake is spring applied / hydraulically released on the front axle input shaft.



Steering

Fully independent power steering.

Front: Fully hydraulic steering wheel controlled.

Rear: Fully hydraulic via separate momentary switch provides infinite variations 4 steering modes, front only, rear only, coordinated and crab. Rear steer not aligned indicator.

Outside 4WS coordinated steer radius: 7,3 m (23.9 ft)

Inside 4WS coordinated steer radius: 4,9 m (16.0 ft)



Tires

29.5 x 25 – 34 bias ply rating



Electrical system

Two 12 V maintenance-free batteries with disconnect.

24 V system / 24 V lighting



Lighting

Full lighting including turn indicators, LED head, tail, brake and hazard warning, and two halogen work lights mounted on cab front.



Maximum Drive Speed

24,1 km/h (15 mph) with 9979 kg (22,000 lb) counterweight

16 km/h (10 mph) with 12 247 kg (27,000 lb) counterweight



Gradeability (theoretical)

70% to drive train stall based on 55 763 kg (122,935 lb) GVW with 29.5 x 25 tires, standard counterweight, auxiliary hoist and manual bi-fold extension.

Miscellaneous standard equipment

Full length steel fenders with full aluminum decking, dual rear view mirrors, hook block tie-down, electronic back-up alarm, front stowage tray, hot water cab heater / defroster, cab air conditioner, hoist mirrors, hourmeter, A/V warning system, combination lift/tie-down/towing lugs, coolant sight level indicator, hoist access platform, CraneSTAR asset management system.

*Optional equipment

- Auxiliary Hoist Package: Includes MTW 19-241 hoist with electronic hoist drum rotation indicator, hoist drum cable follower, third wrap indicator with hoist function cut-out, 214 m (702 ft) of 19 mm (¾ in.) of 35 x 7 class rotation resistant wire rope.
- Auxiliary Lighting and Convenience Package: Includes superstructure mounted amber flashing light, dual base boom mounted floodlights, in-cab R.C.L. light bar and rubber mat for storage trough.
- 10 m - 17 m (33 ft – 56 ft) Manual bi-fold swingway extension
- 10 m – 17 m (33 ft – 56 ft) hydraulic luffing extension
- 3 m (10 ft) heavy-duty extension with two sheaves
- 5000 lb (2268 kg) additional counterweight slab
- 360° NYC style mechanical swing lock
- Rear pintle hitch
- Cab-controlled cross axle differential locks (front and rear)
- Wireless wind speed indicator
- Vertical R.C.L. light tower
- -29C / -20F cold weather package
- -40C / -40F arctic weather package
- Electric drive line retarder
- Emergency stop buttons on each side of carrier
- Second beacon light
- Refinery package (certified spark arrestor + engine air shutdown) (T3 engine only)
- C.E. certificate package
- Russian certificate package
- Synthetic rope for main and / or auxiliary hoist

** Denotes optional equipment*

Symbols Glossary

 Axles	 Crane control system	 Heavy duty jib	 Outriggers
 Boom	 Drive	 Height (no max)	 Radius
 Boom elevation	 Electrical system	 Hoist	 Rotation
 Boom extension	 Engine	 Hook block	 Speed
 Boom length	 Extension	 Hydraulic system	 Steering
 Boom nose	 Frame	 Insert	 Suspension
 Brakes	 Fuel tank capacity	 Lights	 Swing
 Cab	 Gear	 Oil	 Tires
 Counterweight	 Grade	 Outrigger controls	 Transmission

Manitowoc Cranes

Regional headquarters

Americas

Manitowoc, Wisconsin, USA

Tel: +1 920 684 6621

Fax: +1 920 683 6277

Shady Grove, Pennsylvania, USA

Tel: +1 717 597 8121

Fax: +1 717 597 4062

Europe and Africa

Dardilly, France - TOWERS

Tel: +33 (0)4 72 18 20 20

Fax: +33 (0)4 72 18 20 00

Wilhelmshaven, Germany - MOBILE

Tel: +49 (0) 4421 294 0

Fax: +49 (0) 4421 294 4301

China

Shanghai, China

Tel: +86 21 6457 0066

Fax: +86 21 6457 4955

Middle East and Greater Asia-Pacific

Singapore

Tel: +65 6264 1188

Fax: +65 6862 4040

Dubai, UAE

Tel: +971 4 8862677

Fax: +971 4 8862678/79



Manitowoc
Crane Care™



Manitowoc
Finance™



This document is non-contractual. Constant improvement and engineering progress make it necessary that we reserve the right to make specification, equipment, and price changes without notice. Illustrations shown may include optional equipment and accessories and may not include all standard equipment.