

GROVE®

by **Manitowoc**

MAXIM

Crane Works, L.P.

1-877-MAX-LIFT

GMK3060

Product Guide

ASME B30.5
Imperial 85%



Features

- 60 t (66 USt) capacity
- 9,7 m – 43 m (32 ft – 141 ft) six-section boom
- Patented TWIN-LOCK™ boom pinning system
- 8,7 m – 15 m (28.5 ft – 49.2 ft) bi-fold swingaway, hydraulic or manual offset
- 13 600 kg (29,983 lb) counterweight with hydraulic removal system
- Cummins QSL9-C350 Tier 4 Final six-cylinder turbo-charged diesel engine. ZF-AS TRONIC transmission
- MEGATRAK™ independent hydro-pneumatic suspension
- New Manitowoc Crane Control System (CCS)
- New carrier cab

GROVE GMK3060

Features

The GMK3060 all-terrain crane combines a powerful, six-section MEGAFORM™ boom with a compact three-axle carrier, making it ideal for a variety of work in tight locations.

> Compact and strong

The GMK3060 not only has the best taxi load charts in its class, but is also the most compact with the shortest overall length and lowest height with the smallest tailswing.

> TWINLOCK™

Boom pinning mechanism automatically pins the sections in position using two horizontal pins. The use of a single telescoping cylinder reduces weight and increases lifting capacities.

> Crane Control System (CCS)

The new crane control system (CCS) offers a user-friendly interface, two full graphic displays mounted vertically for better visibility, a jog dial for easier data input and ergonomic joysticks.

> Additional counterweight

Additional counterweight for improved load capacities and outstanding taxi configuration

> Engine

Cummins QSL9, 6 cylinder in-line, water cooled, turbo charged engine. High pressure fuel injection system, electronic engine management, and meets all Tier 4 Final/ Euromot 4 requirements.

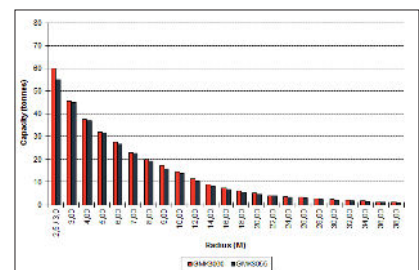

Jobsite benefits

- Higher and stronger. With a maximum boom and extension length of 58 m (190.2 ft) the crane can still lift 2,5 t (2.8 USt).
- Increased flexibility with multiple counterweight configurations that provide optimal Taxi arrangements.
- Three outrigger positions provide ultimate flexibility for job sites with the ability to position the crane in tighter spaces.
- MEGATRAK™ independent suspension, all-wheel steering system and steer by wire technology provides increased ground clearance, adjustable suspension and reduces tire-wear to provide maximum maneuverability in all-terrains.
- Compact length and a minimum width of 2,55 m (8.4 ft) allow access to even the most narrow of jobsites, while optimizing crane set up and lifting position.
- The new Boom Configurator mode thru the Crane Control System (CCS) simplifies the telescoping process and makes job site set up quick and easy.



The assurance of the world's most advanced crane service and support to get you back to work fast.



Financial tools that help you capitalize on opportunity with solutions that fit your needs.

Contents

Dimensions _____	5
Weights _____	6
Counterweight _____	7
Data _____	8
Load charts	
Working range main boom _____	9
Load charts main boom _____	10
Working range main boom and hydraulic offsettable swingaway _____	18
Load chart main boom and hydraulic offsettable swingaway _____	19
Specification _____	25
Symbols glossary _____	26

Weights

Boom over front

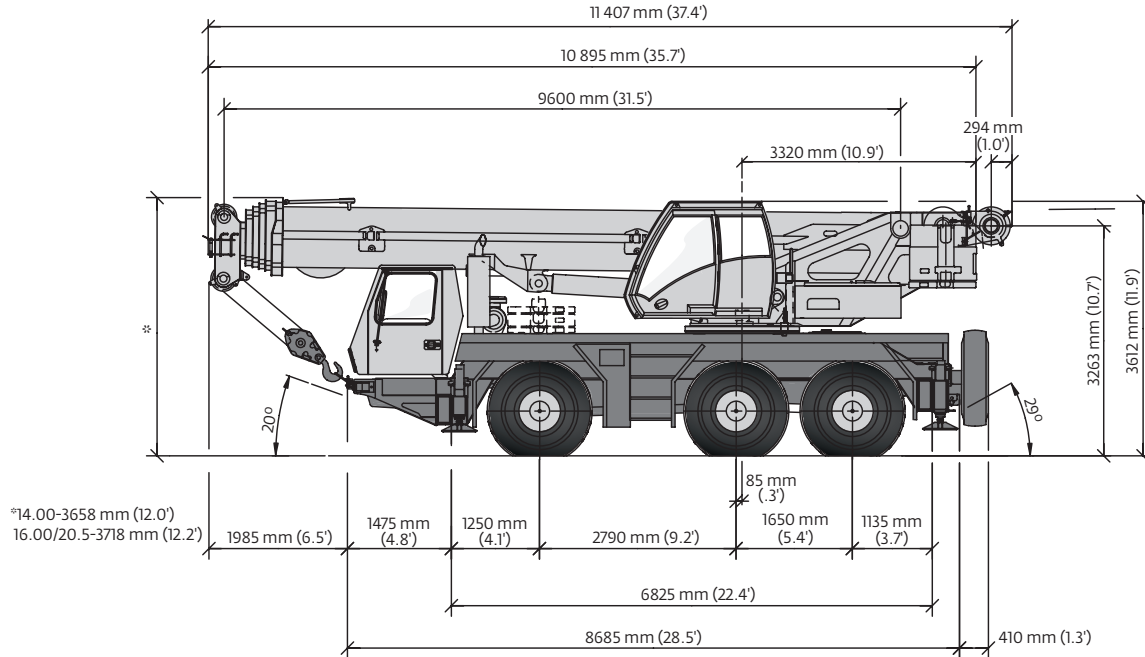



Boom over front

Basic weights - kg lb	Axle 1		Axles 2 and 3		Total	
Cummins power, 28.5 ft – 49.2 ft hydraulic offset swingaway including brackets and hose reel, 16.00R25 tires, 6x4x6 drive/steer, 2nd oil cooler, auxiliary boom nose, auxiliary hoist, 6600 kg (14,550 lb) counterweight fixed to superstructure, polymer outrigger pads, single-sheave 16 t (18 USt) hook block, driver and tanks filled.	11 590 kg	25,540 lb	24 640 kg	54,340 lb	36 230 kg	79,880 lb
Additions:						
6x6 drive/steer	379 kg	836 lb	19 kg	42 lb	398 kg	878 lb
Electric driveline retarder	-17 kg	-37 lb	186 kg	411 lb	170 kg	375 lb
Spare wheel 14.00 R25 XGC steel rim with stowage	-183 kg	-403 lb	454 kg	1000 lb	271 kg	597 lb
Spare wheel 16.00 R25 XGC steel rim with stowage	-219 kg	-482 lb	543 kg	1196 lb	324 kg	714 lb
Spare wheel 20.5 R25 XGC steel rim with stowage	-261 kg	-576 lb	648 kg	1429 lb	387 kg	853 lb
1000 kg (2200 lb) pinned to superstructure	-600 kg	-1323 lb	1621 kg	3574 lb	1021 kg	2251 lb
2000 kg (4400 lb) pinned to superstructure	-1205 kg	-2657 lb	3257 kg	7181 lb	2052 kg	4524 lb
1000 kg (2200 lb) base plate on carrier deck	1039 kg	2298 lb	3 kg	8 lb	1042 kg	2298 lb
2000 kg (4400 lb) carrier deck	2066 kg	4556 lb	7 kg	15 lb	2073 kg	4571 lb
Substitutions:						
14.00R25 tires	-106 kg	-234 lb	-212 kg	-467 lb	-318 kg	-701 lb
20.5R25 tires	126 kg	278 lb	252 kg	556 lb	378 kg	833 lb
Removals:						
Brackets for hydraulic swingaway	-71 kg	-157 lb	11 kg	24 lb	-60 kg	-132 lb
Hose reel for hydraulic swingaway	-120 kg	-265 lb	55 kg	122 lb	-65 kg	-143 lb
8.7 m – 15 m (28.5 ft – 49.2 ft) hydraulic swingaway	-1019 kg	-2247 lb	134 kg	296 lb	-885 kg	-1951 lb
Auxiliary boom nose	-128 kg	-283 lb	68 kg	151 lb	-60 kg	-132 lb
Outrigger floats front	-135 kg	-220 lb	35 kg	76 lb	-100 kg	-220 lb
Outrigger floats rear	54 kg	120 lb	-154 kg	-340 lb	-100 kg	-220 lb

Counterweight

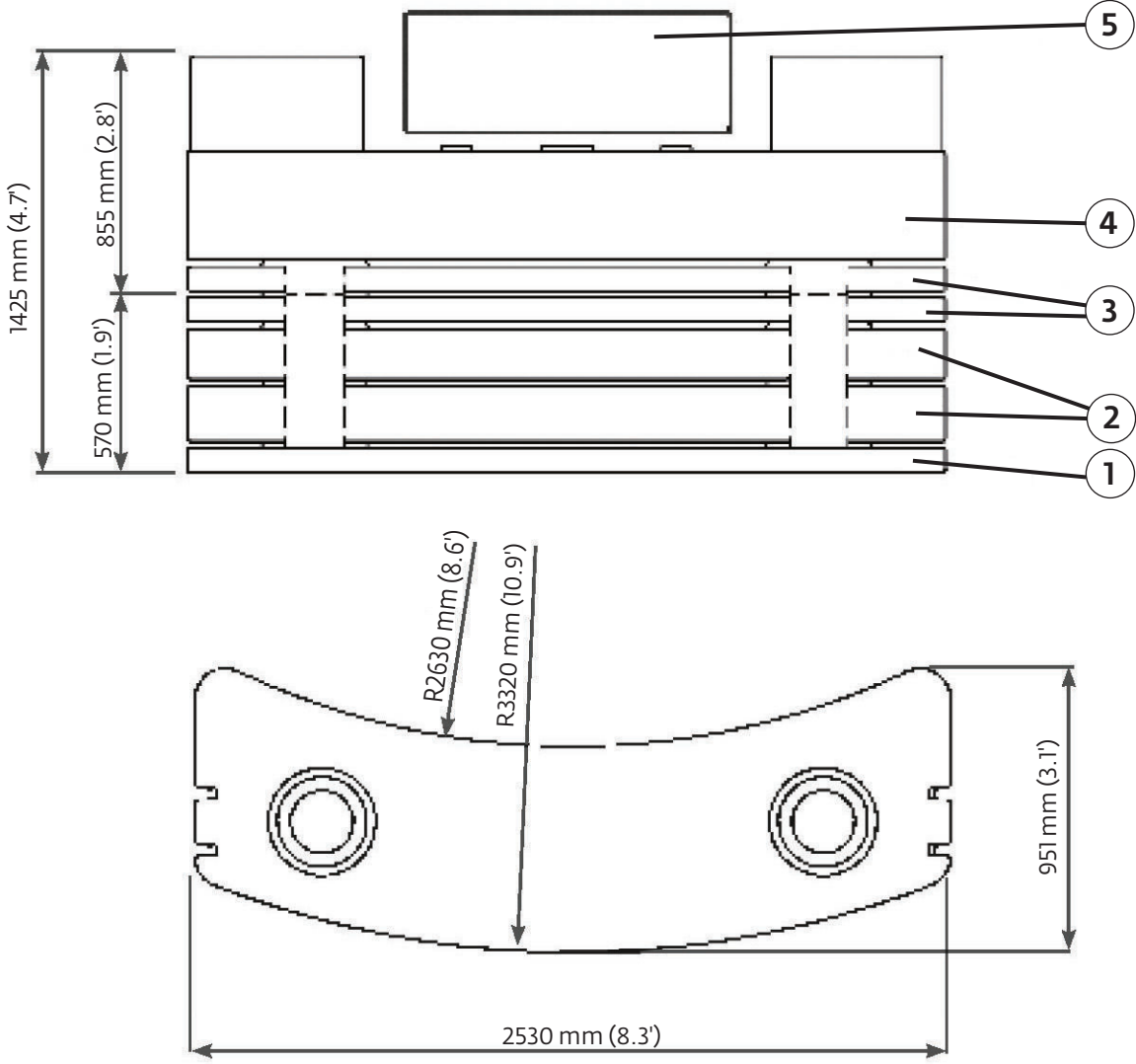
Counterweight



	1 1,0 t (1.1 USt)	2 2,0 t (2.2 USt)	3 1,0 t (1.1 USt)	4* 5,6 t (6.2 USt)	5 1,0 t (1.1 USt)**
6,6 t (7.3 USt)				X	X
7,6 t (8.4 USt)			X	X	X
8,6 t (9.5 USt)	X		X	X	X
9,6 t (10.6 USt)	X	X		X	X
10,6 t (11.7 USt)	X	X	X	X	X
11,6 t (12.8 USt)	X	2X		X	X
12,6 t (13.9 USt)	X	2X	X	X	X
13,6 t (15.0 USt)	X	2X	2X	X	X

*Fixed at turntable

** Two 0,5 t (0.55 USt) or one 0,5 t (0.55 USt) + auxiliary hoist

Data



Axle	1	2	3	Total weight
t (USt)	12 (13.2 USt)	12 (13.2 USt)	12 (13.2 USt)	36 t (39.7 USt)*

* with 7,6 t counterweight, 8,7/15 m bi-fold swingaway, 40 t hook block, 385/95/ R25 tires or 8,6 t counterweight, 40 t hook block, 385/95/ R25 tires



Lifting Capacity	Sheaves	Weight	Parts of line	Possible load with crane*
63 t (69 USt)	5	600 kg (1322 lb)	2 - 10 t / ■11	50 t (65 USt)■
40 t (44 USt)	3	360 kg (793 lb)	2 - 7	35 t (38 USt)
16 t (17.6 USt)	1	210 kg (463 lb)	1 - 3	15 t (16.5 USt)
8 t (9 USt)	over haul weight	200 kg (440 lb)	1	5 t (5.5 USt)

■ Requires additional boom nose sheave
*Varies depending on national regulations

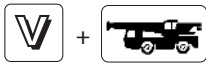

	1	2	3	4	5	6	7	8	9	10	11	12	R1	R2	
mph	3.5	4	5.2	6.7	8.5	10.9	14.4	18.5	23.8	30.5	38.8	49.7	3.4	4.3	82 %
	14.00 R25														



	Infinitely variable	Rope	Permissible line pull max.
	0 - 120 m/min (394 fpm)	single line	16 mm / 170 m (558 ft) 50 kN (11,240 lb)
	0 - 120 m/min (394 fpm)	single line	16 mm / 170 m (558 ft) 50 kN (11,240 lb)
	0 - 2,5 min ⁻¹		
	-2,7° to + 83°	< 40 s	
	9,7 to 43,0 m (32 ft - 141 ft)	270 s	

Working range

Main boom

9,7 m - 43 m (32 ft - 141 ft) main boom

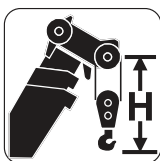
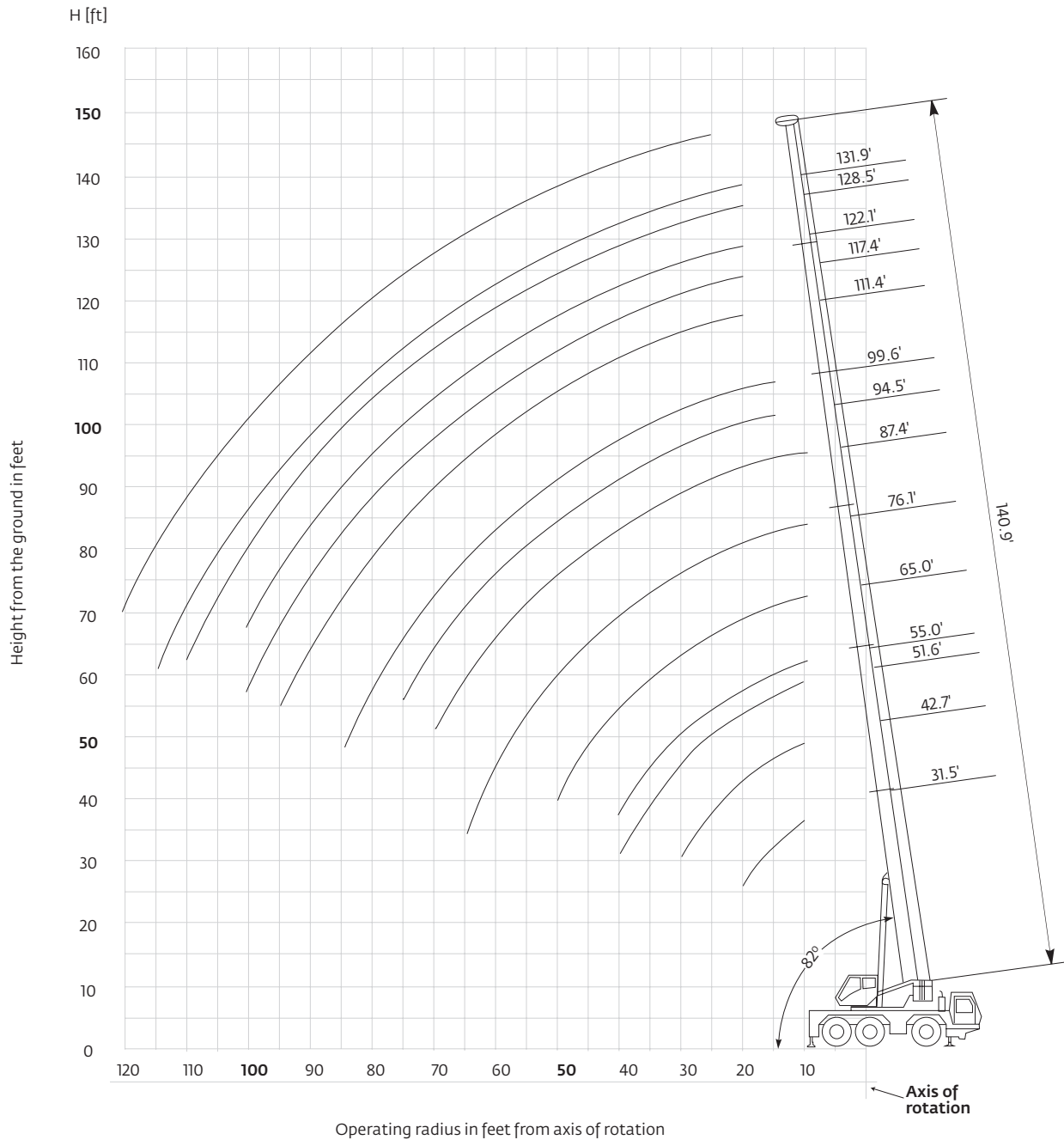

Hook block	H
69 USt, 5-sheave quick-reeving	3300 mm (10.8 ft)
44 USt, 3-sheave quick-reeving	3200 mm (10.5 ft)
18 USt, 1-sheave quick-reeving	3100 mm (10.2 ft)
9 USt single overhaul ball	2700 mm (8.9 ft)

Tip heights shown in the working range diagram do not consider loaded boom deflection.

Load chart

Main boom



9,7 m – 43,0 m
(32 ft – 141 ft)



13 600 kg
(29,900 lb)



6,8 m x 6,2 m
(22.4 ft x 20.4 ft)
100%



360°



Pounds x 1000

Feet	32	43	54	65	76	89	100	111	122	132	141
8	130.00 **/ 120.00 *										
9	114.00 *										
10	106.00 *	102.00	95.00	88.00	74.00	54.00					
15	83.00 *	80.00	77.00	71.00	64.00	47.00	42.00				
20	62.00	63.00	62.00	58.00	54.00	41.00	36.80	32.60	26.20	20.80	
25		49.00	49.00	48.00	46.00	36.20	32.00	29.20	25.60	20.80	17.60
30		39.40	39.40	36.80	36.40	32.20	27.20	25.80	23.60	20.80	17.60
35			31.60	31.20	29.60	29.00	23.40	22.20	21.20	19.20	17.60
40			26.40	26.40	24.60	24.80	20.80	19.80	19.20	17.80	16.40
45				21.80	21.80	21.20	18.40	17.60	17.00	16.40	15.20
50				18.40	19.20	18.20	16.40	15.60	15.20	15.00	14.20
55					16.60	16.00	14.80	14.00	13.60	13.40	13.00
60					14.40	13.80	12.80	12.60	12.00	12.00	11.80
65					12.60	12.00	11.40	11.00	10.60	10.40	10.60
70						10.40	9.80	9.60	9.60	9.60	9.60
75						7.60	8.60	8.60	8.60	8.80	9.00
80							7.40	7.40	7.60	7.80	8.00
85							6.40	6.40	6.60	7.00	7.20
90								5.60	5.80	6.20	6.40
95								4.80	5.00	5.40	5.80
100									4.40	4.60	5.00
105										4.00	4.40
110										3.60	3.80
115										3.00	3.40
120											3.00

**Over rear with special equipment

*Over rear

Load charts

Main boom



9,7 m – 43,0 m
(32 ft – 141 ft)



12 600 kg
(27,700 lb)



6,8 m x 6,2 m
(22.4 ft x 20.4 ft)
100%



360°



Pounds x 1000



Feet	32	43	54	65	76	89	100	111	122	132	141
8	120.00 *										
9	114.00 *										
10	106.00 *	102.00	95.00	88.00	74.00	54.00					
15	83.00 *	79.00	77.00	71.00	64.00	47.00	42.00				
20	61.00	62.00	61.00	58.00	54.00	41.00	36.80	32.60	26.20	20.80	
25		48.00	48.00	46.00	45.00	36.20	32.00	29.20	25.60	20.80	17.60
30		38.80	37.80	35.80	35.00	32.20	27.20	25.80	23.60	20.80	17.60
35			31.00	30.20	28.40	28.40	23.40	22.20	21.20	19.20	17.60
40			25.40	25.20	23.80	23.80	20.80	19.80	19.20	17.80	16.40
45				20.80	21.60	20.20	18.40	17.60	17.00	16.40	15.20
50				17.60	18.40	17.40	16.20	15.60	15.20	15.00	14.20
55					15.80	15.20	14.00	13.60	13.40	13.40	13.00
60					13.80	13.20	12.20	11.80	11.80	12.00	11.80
65					12.00	11.40	10.60	10.40	10.20	10.40	10.60
70						9.80	9.20	9.00	9.00	9.20	9.40
75						7.00	8.00	8.00	8.00	8.20	8.40
80							6.80	6.80	7.00	7.20	7.40
85							6.00	5.80	6.00	6.40	6.60
90								5.00	5.20	5.60	6.00
95								4.40	4.60	5.00	5.20
100									3.80	4.20	4.60
105										3.60	4.00
110										3.20	3.40
115										2.60	3.00
120											2.60

*Over rear

THIS CHART IS ONLY A GUIDE AND SHOULD NOT BE USED TO OPERATE THE CRANE.

The individual crane's load chart, operating instructions and other instructional plates must be read and understood prior to operating the crane

Load charts

Main boom



9,7 m – 43,0 m
(32 ft – 141 ft)



11 600 kg
(25,500 lb)



6,8 m x 6,2 m
(22,4 ft x 20,4 ft)
100%



360°



Pounds x 1000

Feet	32	43	54	65	76	89	100	111	122	132	141
8	120.00 *										
9	114.00 *										
10	103.00	102.00	95.00	88.00	74.00	54.00					
15	79.00	79.00	77.00	71.00	64.00	47.00	42.00				
20	60.00	61.00	60.00	58.00	54.00	41.00	36.80	32.60	26.20	20.80	
25		47.00	47.00	43.80	42.80	36.20	32.00	29.20	25.60	20.80	17.60
30		37.20	36.20	35.60	33.40	32.20	27.20	25.80	23.60	20.80	17.60
35			30.20	29.00	27.00	27.20	23.40	22.20	21.20	19.20	17.60
40			24.20	24.00	23.80	27.20	20.80	19.80	19.20	17.80	16.40
45				20.00	20.60	22.60	18.00	17.40	17.00	16.40	15.20
50				17.40	17.60	19.20	15.40	14.80	14.80	14.80	14.20
55					15.00	16.60	13.20	12.80	12.80	12.80	13.00
60					13.00	14.40	11.40	11.20	11.00	11.20	11.40
65					11.40	12.40	10.00	9.60	9.60	9.80	10.00
70						10.60	8.60	8.40	8.40	9.20	8.80
75						9.20	7.40	7.40	7.40	8.60	7.80
80						6.40	6.20	6.20	6.40	7.80	7.00
85							5.40	5.40	5.60	6.80	6.20
90								4.60	4.80	6.20	5.40
95								3.80	4.00	5.40	4.80
100									3.40	4.80	4.20
105										4.20	3.60
110										3.60	3.20
115										2.20	2.60
120											2.20

*Over rear

THIS CHART IS ONLY A GUIDE AND SHOULD NOT BE USED TO OPERATE THE CRANE.

The individual crane's load chart, operating instructions and other instructional plates must be read and understood prior to operating the crane

Load charts

Main boom



9,7 m – 43,0 m
(32 ft – 141 ft)



10 600 kg
(23,300 lb)



6,8 m x 6,2 m
(22.4 ft x 20.4 ft)
100%



360°



Pounds x 1000

Feet	32	43	54	65	76	89	100	111	122	132	141
10	103.00	102.00	95.00	88.00	74.00	54.00					
15	79.00	79.00	77.00	71.00	64.00	47.00	42.00				
20	60.00	60.00	59.00	57.00	54.00	41.00	36.80	32.60	26.20	20.80	
25		47.00	45.00	41.80	41.00	36.20	32.00	29.20	25.60	20.80	17.60
30		35.40	35.40	34.00	32.00	31.80	27.20	25.80	23.60	20.80	17.60
35			28.80	27.60	26.40	26.00	23.40	22.20	21.20	19.20	17.60
40			23.20	22.80	23.00	21.60	20.20	19.40	19.20	17.80	16.40
45				19.00	19.60	18.20	17.00	16.40	16.20	16.40	15.20
50				17.00	16.80	15.60	14.40	14.00	13.80	14.00	14.20
55					14.20	13.60	12.40	12.00	12.00	12.40	12.20
60					12.20	11.60	10.60	10.40	10.40	11.00	10.60
65					10.60	10.00	9.20	9.00	9.00	9.80	9.40
70						8.60	8.00	7.80	8.40	9.00	8.20
75						5.80	7.40	6.80	7.80	8.00	7.20
80							5.80	5.80	7.20	7.20	6.40
85							4.80	4.80	6.60	6.40	5.60
90								4.20	5.80	5.60	5.00
95								3.40	5.20	5.00	4.40
100									4.60	4.40	3.80
105										3.80	3.20
110										3.20	2.80
115										2.00	2.20
120											1.80

THIS CHART IS ONLY A GUIDE AND SHOULD NOT BE USED TO OPERATE THE CRANE.

The individual crane's load chart, operating instructions and other instructional plates must be read and understood prior to operating the crane

Load charts

Main boom



9,7 m - 43,0 m
(32 ft - 141 ft)



9600 kg
(21,100 lb)



6,8 m x 6,2 m
(22.4 ft x 20.4 ft)
100%



360°



Pounds x 1000

Feet	32	43	54	65	76	89	100	111	122	132	141
10	103.00	102.00	95.00	88.00	74.00	54.00					
15	79.00	79.00	77.00	71.00	64.00	47.00	42.00				
20	59.00	59.00	57.00	54.00	53.00	41.00	36.80	32.60	26.20	20.80	
25		46.00	42.80	39.80	39.20	36.20	32.00	29.20	25.60	20.80	17.60
30		33.80	34.40	32.60	30.40	30.20	27.20	25.80	23.60	20.80	17.60
35			27.40	26.20	26.40	24.60	23.00	22.20	21.20	19.20	17.60
40			22.00	21.80	22.00	20.40	19.00	18.40	18.20	17.80	16.40
45				19.00	18.60	17.40	16.00	15.60	15.40	15.40	15.20
50				16.20	15.80	14.80	13.60	13.20	13.00	13.20	13.20
55					13.40	12.80	11.60	11.20	11.40	11.20	11.40
60					11.60	10.80	10.00	9.60	10.20	9.80	10.00
65					10.00	9.20	8.60	8.20	9.00	8.40	8.60
70						8.00	7.20	7.20	8.40	7.40	7.60
75						5.20	6.20	6.20	7.80	6.40	6.60
80							5.20	5.20	7.00	5.60	5.80
85							4.40	4.40	6.20	4.80	5.00
90								3.60	5.40	4.20	4.40
95								3.00	4.80	3.60	3.80
100									4.20	3.00	3.40
105										2.40	2.80
110										2.00	2.40
115										1.60	2.00
120											1.60

THIS CHART IS ONLY A GUIDE AND SHOULD NOT BE USED TO OPERATE THE CRANE.

The individual crane's load chart, operating instructions and other instructional plates must be read and understood prior to operating the crane

Load charts

Main boom



9,7 m – 43,0 m
(32 ft – 141 ft)



8600 kg
(18,900 lb)



6,8 m x 6,2 m
(22.4 ft x 20.4 ft)
100%



360°



Pounds x 1000

Feet	32	43	54	65	76	89	100	111	122	132	141
10	103.00	102.00	95.00	88.00	74.00	54.00					
15	78.00	79.00	77.00	71.00	64.00	47.00	42.00				
20	58.00	58.00	56.00	52.00	50.00	41.00	36.80	32.60	26.20	20.80	
25		43.40	40.80	40.00	37.20	36.20	32.00	29.20	25.60	20.80	17.60
30		32.80	32.60	31.00	29.60	28.80	26.80	25.80	23.60	20.80	17.60
35			26.00	25.00	25.00	23.40	21.80	21.00	20.60	19.20	17.60
40			20.80	20.80	20.80	19.40	18.00	17.40	17.00	17.20	16.40
45				18.20	17.60	16.20	15.00	14.60	14.40	15.00	14.60
50				15.20	15.00	13.80	12.60	12.20	12.00	13.40	12.40
55					12.60	11.80	10.80	10.40	10.20	11.60	10.60
60					10.80	10.00	9.40	8.80	8.80	10.20	9.20
65					9.20	8.60	8.80	7.60	7.60	8.80	8.00
70						7.40	8.00	6.40	6.40	7.80	7.00
75						4.60	7.40	5.60	5.60	6.80	6.00
80							4.60	4.60	4.80	6.00	5.20
85							3.80	3.80	4.00	5.40	4.60
90								3.20	3.40	4.60	4.00
95								2.60	2.80	4.00	3.40
100									2.20	3.40	3.00
105										3.00	2.40
110										2.60	2.00
115											1.60

Load charts

Main boom



9,7 m - 43,0 m
(32 ft - 141 ft)



7600 kg
(16,700 lb)



6,8 m x 6,2 m
(22.4 ft x 20.4 ft)
100%



360°



Pounds x 1000

Feet	32	43	54	65	76	89	100	111	122	132	141
10	102.00	102.00	95.00	88.00	74.00	54.00					
15	78.00	79.00	77.00	71.00	64.00	47.00	42.00				
20	57.00	57.00	54.00	49.00	48.00	41.00	36.80	32.60	26.20	20.80	
25		41.40	40.40	38.00	35.60	35.00	32.00	29.20	25.60	20.80	17.60
30		31.00	31.00	29.40	29.20	27.40	25.40	24.40	23.60	20.80	17.60
35			24.60	23.60	23.80	22.20	20.60	19.80	19.40	19.20	17.60
40			19.40	20.80	19.60	18.20	16.80	16.20	16.00	16.00	16.00
45				17.20	16.60	15.20	14.00	13.40	14.20	13.40	13.60
50				14.40	14.00	12.80	11.80	11.40	12.60	11.40	11.60
55					11.80	11.00	10.60	9.60	11.40	9.60	9.80
60					10.00	9.40	9.40	8.00	9.80	8.20	8.40
65					8.60	8.00	8.80	6.80	8.60	7.20	7.40
70						6.80	8.00	5.80	7.60	6.00	6.40
75						4.20	7.40	5.00	6.60	5.20	5.40
80							4.20	4.20	5.80	4.40	4.80
85							3.40	3.40	5.20	3.80	4.00
90								2.60	4.40	3.20	3.40
95								2.00	3.80	2.60	3.00
100									3.40	2.20	2.40
105										1.60	2.00
110											1.60

Load charts

Main boom



9,7 m – 43,0 m
(32 ft – 141 ft)



6600 kg
(14,500 lb)



6,8 m x 6,2 m
(22.4 ft x 20.4 ft)
100%



360°



Pounds x 1000

Feet	32	43	54	65	76	89	100	111	122	132	141
10	102.00	102.00	95.00	88.00	74.00	54.00					
15	78.00	78.00	77.00	71.00	64.00	47.00	42.00				
20	56.00	55.00	51.00	49.00	45.00	41.00	36.80	32.60	26.20	20.80	
25		39.20	38.40	36.20	33.60	33.20	30.80	29.20	25.60	20.80	17.60
30		29.20	29.40	27.80	27.80	25.80	24.00	23.00	22.40	20.80	17.60
35			23.00	23.40	22.40	20.80	19.20	18.40	18.20	18.00	17.60
40			18.20	19.60	18.40	17.00	15.60	15.00	15.80	16.20	15.00
45				16.00	15.40	14.20	13.20	12.40	14.20	13.60	12.60
50				13.40	13.00	11.80	11.80	10.40	12.20	11.60	10.60
55					11.00	10.00	10.60	8.80	10.60	10.00	9.00
60					9.20	8.60	9.40	7.40	9.20	8.60	7.80
65					7.80	7.20	8.80	6.20	8.00	7.40	6.60
70						6.00	7.80	5.20	7.00	6.40	5.60
75						3.60	6.80	4.40	6.00	5.60	4.80
80							3.60	3.60	5.40	5.00	4.20
85							2.80	2.80	4.60	4.20	3.60
90								2.20	4.00	3.60	3.00
95								1.60	3.40	3.20	2.40
100									2.80	2.60	2.00
105										2.20	1.60
110										1.80	

Working range

Hydraulic offsettable swingaway

9,7 m - 43 m (32 ft - 141 ft) main boom with 8,7 m - 15 m (28.5 ft - 49.2 ft) swingaway

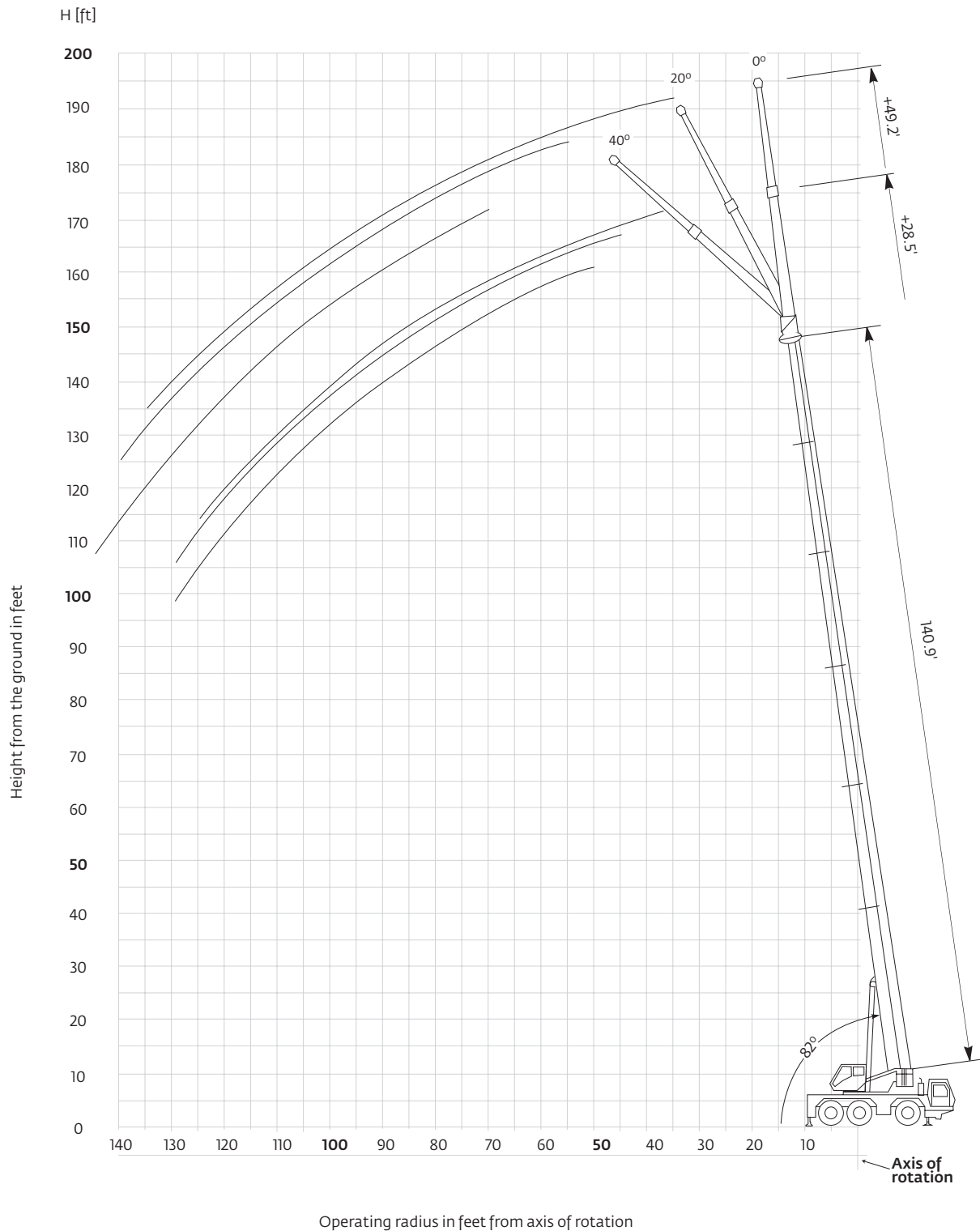





Tip heights shown in the working range diagram do not consider loaded boom deflection.

THIS CHART IS ONLY A GUIDE AND SHOULD NOT BE USED TO OPERATE THE CRANE.

The individual crane's load chart, operating instructions and other instructional plates must be read and understood prior to operating the crane.

Load charts

Hydraulic offsettable swingaway

40,2 m - 43,0 m
(131.9 ft - 140.9 ft)

8,7 m
(28.5 ft)

13,600 kg
(29,900 lb)

6,8 m x 6,2 m
(22.4 ft x 20.4 ft)
100%

360°



Pounds x 1000

Feet	132 28.5					141 28.5				
	0°	20°	40°	*0° - 20°	*20° - 40°	0°	20°	40°	*0° - 20°	*20° - 40°
30	11.2									
35	11.2					9.4				
40	11.2	9.6		5.6		9.4				
45	10.8	9.2		5.2		9.4	8.8		5.4	
50	10.6	9.0	7.6	5.0	4.2	9.4	8.8	7.4	5.2	4.2
55	10.0	8.8	7.4	4.8	4.0	8.8	8.2	7.4	5.0	4.0
60	9.4	8.4	7.2	4.6	4.0	8.2	7.8	7.2	4.8	4.0
65	8.8	8.2	7.2	4.4	3.8	7.8	7.4	7.2	4.6	3.8
70	8.4	7.8	7.0	4.4	3.8	7.4	7.0	6.8	4.4	3.8
75	7.8	7.6	7.0	4.2	3.8	7.0	6.6	6.6	4.2	3.8
80	7.2	7.2	6.8	4.0	3.6	6.6	6.4	6.2	4.2	3.8
85	6.6	6.6	6.8	4.0	3.6	6.2	6.0	6.0	4.0	3.6
90	5.8	5.8	6.2	3.8	3.6	6.0	5.8	5.8	4.0	3.6
95	5.2	5.2	5.6	3.8	3.6	5.2	5.2	5.4	3.8	3.6
100	4.8	5.0	5.0	3.6	3.6	4.8	4.8	5.0	3.8	3.6
105	4.6	4.6	4.8	3.6	3.6	4.2	4.2	4.4	3.6	3.6
110	4.2	4.4	4.4	3.4	3.4	3.6	3.6	4.0	3.4	3.6
115	3.8	3.8	4.0	3.4	3.4	3.2	3.2	3.4	3.0	3.2
120	3.4	3.4	3.6	3.0	3.2	2.8	2.8	3.0	2.6	2.8
125	3.0	3.0	3.2	2.8	2.8	2.4	2.4	2.6	2.2	2.4
130	2.6	2.6	2.6	2.4	2.4	2.0	2.0	2.2	1.8	2.0
135	2.2	2.2	2.4	2.0	2.2	1.6	1.6	1.8	1.6	1.6
140						1.4	1.4	1.4		1.4

THIS CHART IS ONLY A GUIDE AND SHOULD NOT BE USED TO OPERATE THE CRANE.

The individual crane's load chart, operating instructions and other instructional plates must be read and understood prior to operating the crane.

Load charts

Hydraulic offsettable swingaway



40,2 m - 43,0 m
(131.9 ft - 140.9 ft)



15,0 m
(49.2 ft)



13,600 kg
(29,900 lb)



6,8 m x 6,2 m
(22.4 ft x 20.4 ft)
100%



360°



Pounds x 1000

Feet	132 49.2					141 49.2				
	0°	20°	40°	*0° - 20°	*20° - 40°	0°	20°	40°	*0° - 20°	*20° - 40°
30	6.4									
35	6.2					5.6				
40	6.2					5.6				
45	6.2					5.6				
50	6.0	5.2		2.8		5.6				
55	6.0	5.0		2.6		5.6	4.8		2.8	
60	6.0	4.8		2.6		5.4	4.8		2.6	
65	5.8	4.6		2.4		5.4	4.6		2.4	
70	5.6	4.6	3.8	2.4	1.8	5.4	4.4	3.8	2.4	1.8
75	5.2	4.4	3.6	2.2	1.8	5.2	4.4	3.6	2.2	1.8
80	5.0	4.2	3.6	2.2	1.8	5.0	4.2	3.6	2.0	1.8
85	5.0	4.2	3.6	2.0	1.8	4.8	4.2	3.6	2.0	1.8
90	4.8	4.0	3.6	2.0	1.8	4.6	4.0	3.6	2.0	1.8
95	4.6	4.0	3.4	1.8	1.6	4.6	4.0	3.4	2.0	1.6
100	4.4	3.8	3.4	1.8	1.6	4.4	3.8	3.4	1.8	1.6
105	4.2	3.8	3.4	1.8	1.6	4.2	3.8	3.4	1.8	1.6
110	4.0	3.6	3.4	1.6	1.6	4.0	3.6	3.4	1.8	1.6
115	3.6	3.4	3.4	1.6	1.6	3.6	3.6	3.4	1.6	1.6
120	3.4	3.2	3.4	1.6	1.6	3.2	3.2	3.2	1.6	1.6
125	3.2	3.0	3.2	1.6	1.6	2.8	2.8	3.2	1.6	1.6
130	3.0	2.6	3.2	1.6	1.6	2.4	2.4	2.8	1.6	1.6
135	2.6	2.4	3.0	1.4	1.4	2.0	2.0	2.6	1.6	1.6
140	2.4	2.0	2.6	1.4	1.4	1.8	1.8	2.2	1.4	1.4
145	2.0	1.8	2.2	1.4	1.4	1.4	1.4	1.8	1.4	1.4
150	1.8	1.4	2.0	1.4	1.4			1.4		
155	1.4		1.6							

THIS CHART IS ONLY A GUIDE AND SHOULD NOT BE USED TO OPERATE THE CRANE.

The individual crane's load chart, operating instructions and other instructional plates must be read and understood prior to operating the crane.

Load charts

Hydraulic offsettable swingaway



40,2 m - 43,0 m
(131.9 ft - 140.9 ft)



8,7 m
(28.5 ft)



11,600 kg
(25,500 lb)



6,8 m x 6,2 m
(22.4 ft x 20.4 ft)
100%



360°



Pounds x 1000

Feet	132 28.5					141 28.5				
	0°	20°	40°	*0° - 20°	*20° - 40°	0°	20°	40°	*0° - 20°	*20° - 40°
30	11.2									
35	11.2					9.4				
40	11.2	9.6		5.6		9.4				
45	10.8	9.2		5.2		9.4	8.8		5.4	
50	10.6	9.0	7.6	5.0	4.2	9.4	8.8	7.4	5.2	4.2
55	10.0	8.8	7.4	4.8	4.0	8.8	8.2	7.4	5.0	4.0
60	9.4	8.4	7.2	4.6	4.0	8.2	7.8	7.2	4.8	4.0
65	8.8	8.2	7.2	4.4	3.8	7.8	7.4	7.2	4.6	3.8
70	8.2	7.8	7.0	4.4	3.8	7.4	7.0	6.8	4.4	3.8
75	7.2	7.2	7.0	4.2	3.8	7.0	6.6	6.6	4.2	3.8
80	6.4	6.4	6.8	4.0	3.6	6.4	6.4	6.2	4.2	3.8
85	6.0	5.8	6.0	4.0	3.6	5.6	5.6	6.0	4.0	3.6
90	5.6	5.6	5.6	3.8	3.6	5.0	5.0	5.4	4.0	3.6
95	5.2	5.2	5.2	3.8	3.6	4.4	4.4	4.8	3.8	3.6
100	4.6	4.6	4.8	3.6	3.6	3.8	3.8	4.2	3.8	3.6
105	4.0	4.0	4.4	3.6	3.6	3.4	3.4	3.6	3.2	3.6
110	3.6	3.6	3.8	3.2	3.4	2.8	2.8	3.2	2.8	3.0
115	3.0	3.0	3.4	2.8	3.0	2.4	2.4	2.8	2.4	2.6
120	2.6	2.6	2.8	2.4	2.6	2.0	2.0	2.4	2.0	2.2
125	2.2	2.2	2.4	2.0	2.2	1.6	1.6	2.0	1.6	1.8
130	2.0	2.0	2.0	1.8	1.8	1.4	1.4	1.6		1.4
135	1.6	1.6	1.6	1.4	1.6					

THIS CHART IS ONLY A GUIDE AND SHOULD NOT BE USED TO OPERATE THE CRANE.

Load charts

Hydraulic offsettable swingaway



40.2 m - 43.0 m
(131.9 ft - 140.9 ft)



15.0 m
(49.2 ft)



11,600 kg
(25,500 lb)



6.8 m x 6.2 m
(22.4 ft x 20.4 ft)
100%



360°



Pounds x 1000





Feet	132 49.2					141 49.2				
	0°	20°	40°	*0° - 20°	*20° - 40°	0°	20°	40°	*0° - 20°	*20° - 40°
30	6.4									
35	6.2					5.6				
40	6.2					5.6				
45	6.2					5.6				
50	6.0	5.2		2.8		5.6				
55	6.0	5.0		2.6		5.6	4.8		2.8	
60	6.0	4.8		2.6		5.4	4.8		2.6	
65	5.8	4.6		2.4		5.4	4.6		2.4	
70	5.6	4.6	3.8	2.4	1.8	5.4	4.4	3.8	2.4	1.8
75	5.2	4.4	3.6	2.2	1.8	5.2	4.4	3.6	2.2	1.8
80	5.0	4.2	3.6	2.2	1.8	5.0	4.2	3.6	2.2	1.8
85	5.0	4.2	3.6	2.0	1.8	4.8	4.2	3.6	2.0	1.8
90	4.8	4.0	3.6	2.0	1.8	4.6	4.0	3.6	2.0	1.8
95	4.6	4.0	3.4	1.8	1.6	4.6	4.0	3.4	2.0	1.6
100	4.2	3.8	3.4	1.8	1.6	4.2	3.8	3.4	1.8	1.6
105	4.0	3.6	3.4	1.8	1.6	3.6	3.6	3.4	1.8	1.6
110	3.8	3.6	3.4	1.8	1.6	3.2	3.2	3.4	1.8	1.6
115	3.4	3.4	3.4	1.6	1.6	2.8	2.8	3.4	1.6	1.6
120	3.2	3.2	3.4	1.6	1.6	2.4	2.4	3.0	1.6	1.6
125	2.8	2.8	3.2	1.6	1.6	2.2	2.2	2.6	1.6	1.6
130	2.4	2.4	2.8	1.6	1.6	1.8	1.8	2.2	1.6	1.6
135	2.0	2.0	2.4	1.4	1.4	1.4	1.4	1.8	1.4	1.6
140	1.8	1.8	2.0	1.4	1.4			1.6		1.4
145	1.4	1.4	1.6	1.4	1.4					
150			1.4		1.4					

THIS CHART IS ONLY A GUIDE AND SHOULD NOT BE USED TO OPERATE THE CRANE.

The individual crane's load chart, operating instructions and other instructional plates must be read and understood prior to operating the crane.

Load charts

Hydraulic offsettable swingaway

40,2 m - 43,0 m
(131.9 ft - 140.9 ft)

8,7 m
(28.5 ft)

6600 kg
(14,500 lb)

6,8 m x 6,2 m
(22.4 ft x 20.4 ft)
100%

360°



Pounds x 1000

Feet	132 28.5					141 28.5				
	0°	20°	40°	° 0° - 20°	° 20° - 40°	0°	20°	40°	*0° - 20°	*20° - 40°
30	11.2									
35	11.2					9.4				
40	11.2	9.6		5.6		9.4				
45	10.8	9.2		5.2		9.4	8.8		5.4	
50	10.0	9.0	7.6	5.0	4.2	9.4	8.8	7.4	5.2	4.2
55	8.6	8.4	7.4	4.8	4.0	8.4	8.2	7.4	5.0	4.0
60	8.0	7.6	7.2	4.6	4.0	7.2	7.2	7.2	4.8	4.0
65	7.0	7.0	7.0	4.4	3.8	6.2	6.2	6.8	4.6	3.8
70	6.0	6.0	6.6	4.4	3.8	5.2	5.2	5.8	4.4	3.8
75	5.2	5.2	5.8	4.2	3.8	4.4	4.4	5.0	4.2	3.8
80	4.6	4.6	5.0	4.0	3.6	3.8	3.8	4.2	3.8	3.8
85	3.8	3.8	4.2	3.8	3.6	3.2	3.2	3.6	3.2	3.6
90	3.4	3.4	3.6	3.4	3.6	2.6	2.6	3.0	2.6	3.0
95	2.8	2.8	3.2	2.8	3.0	2.2	2.2	2.4	2.2	2.4
100	2.4	2.4	2.6	2.4	2.6	1.6	1.6	2.0	1.6	2.0
105	2.0	2.0	2.2	2.0	2.2			1.6		1.6
110	1.6	1.6	1.8	1.6	1.8					
115			1.4		1.4					

THIS CHART IS ONLY A GUIDE AND SHOULD NOT BE USED TO OPERATE THE CRANE.

Load charts

Hydraulic offsettable swingaway



40,2 m - 43,0 m
(131.9 ft - 140.9 ft)



15,0 m
(49.2 ft)



6600 kg
(14,500 lb)



6,8 m x 6,2 m
(22.4 ft x 20.4 ft)
100%



360°



Pounds x 1000

Feet	132 49.2					141 49.2				
	0°	20°	40°	*0° - 20°	*20° - 40°	0°	20°	40°	*0° - 20°	*20° - 40°
30	6.4									
35	6.2					5.6				
40	6.2					5.6				
45	6.2					5.6				
50	6.0	5.2		2.8		5.6				
55	6.0	5.0		2.6		5.6	4.8		2.8	
60	6.0	4.8		2.6		5.4	4.8		2.6	
65	5.8	4.6		2.4		5.4	4.6		2.4	
70	5.6	4.6	3.8	2.4	1.8	5.4	4.4	3.8	2.4	1.8
75	5.2	4.4	3.6	2.2	1.8	4.8	4.4	3.6	2.2	1.8
80	4.8	4.2	3.6	2.2	1.8	4.2	4.2	3.6	2.2	1.8
85	4.2	4.0	3.6	2.0	1.8	3.4	3.4	3.6	2.0	1.8
90	3.6	3.6	3.6	2.0	1.8	3.0	3.0	3.6	2.0	1.8
95	3.2	3.2	3.4	1.8	1.6	2.4	2.4	3.2	2.0	1.6
100	2.8	2.8	2.8	1.8	1.6	2.0	2.0	2.8	1.8	1.6
105	2.4	2.4	2.4	1.8	1.6	1.6	1.6	2.2	1.6	1.6
110	2.0	2.0	2.0	1.6	1.6	1.2	1.2	1.8	1.2	1.6
115	1.6	1.6	1.8	1.6	1.6			1.4		1.4
120	1.4	1.4	1.4		1.6					
125					1.4					

The lifting capacities correspond to ASME B30.5

The lifting capacities likewise fulfill the requirements of SAEJ1289 and ISO 4305 with regard to stability.

The lifting capacities are given in 1000 lb.

Lifting capacity = Payload + weight of hook block and suspending device.

The lifting capacities for the main boom only apply with the jib dismantled.

Lifting capacities > 54.4 t (120,000 lb) require optional equipment

Lifting capacities > 59 t (130,000 lb) require special equipment

The right is reserved to modify the load-carrying capacities.

Note: The details in this brochure serve only as general information. The determinant values for the operation of the crane are the lifting capacity tables belonging to it and the operating instructions.

Lifting capacities are indicated by boom length for different levels of extension. The actual boom length will be in accordance with the selected configuration for boom extension.

Specifications

Superstructure



Boom

9,7 m to 43,0 m (32 ft - 141 ft) six-section TWIN-LOCK™ boom. Maximum tip height 45,5 m (150 ft).



Boom elevation

Single cylinder with safety valve, boom angle from -2,7° to +82°.



Load moment and independent anti-two block system

Load moment and independent anti-two block system with audio visual warning and control lever lock-out. These systems provide graphic display of boom angle, length, radius, tip height, relative load moment, maximum permissible load, load indication and warning of impending two-block condition with lock-out hoist function.



Cab

Aluminium, tilting (approx. 20°), full vision, safety glass, adjustable operator's seat with suspension, engine-independent heater. Armrest-integrated crane controls. Ergonomically arranged instrumentation and crane operating controls. Drive/steer controls.



Slewing

Axial piston fixed displacement motor, planetary gear, service brake and holding brake.



Counterweight

7600 kg (16,700 lb) consisting of various sections. Hydraulic removal system from the crane cab.



Hydraulic system

2 separate pump circuits operating in an open circuit with 1 axial piston variable displacement pump (load sensing) and 1 geared constant delivery pump for slewing. Thermostatically controlled oil cooler. Tank capacity: 600 l (159 gal).



Control system

Full electronic control of all crane movements using electrical control levers with automatic reset to zero. Integrated with the LMI and engine management system by CAN-BUS. Crane Control System (CCS) with graphic display.



Hoist

Axial piston motor with planetary gear and brake. Drum rotation indicator.

* Optional equipment

- Bi-fold swingaway, 8,7 m/15 m (28.5 ft/49.2 ft) with hydraulically offset and luffing under load (0°-40°), controlled from the cab
- Bi-fold swingaway, 8,7 m/15 m (28.5 ft/49.2 ft) (manual offset 0°, 20°, 40°).
- Additional 6000 kg (13,200 lb) counterweight providing a total maximum counterweight of 13 600 kg (29,900 lb)
- Auxiliary hoist
- Additional strobe light for carrier and superstructure cab
- Boom position indicator light - flashing or constant
- Windspeed indicator
- Worklights mounted on base section
- Hook blocks/overhaul weight
- Retractable cab foot walk
- Radio with bluetooth, USB and CD player for superstructure cab
- Air conditioning – combined system for both cabs
- Wireless remote control for all crane functions
- Automatic centralized lubrication for superstructure
- 360° positive swing lock

Carrier



Chassis

Special 3-axle chassis, all-welded torsion-resistant box type construction in high strength steel.



Outriggers

4 hydraulically telescoping beams with vertical cylinders and outrigger pads. Independent horizontal and vertical movement control on each side of carrier and from the crane operator's cab. Electronic level indicator with automatic levelling system. Includes outrigger monitoring system.



Engine

Cummins QSL9-C350, diesel, 6-cylinder in-line, water cooled turbocharged and intercooled, 261 kW (350 HP) at 2100 rpm, Max torque 1491 Nm (1100 ft lb) at 1500 rpm. Engine emission: Euromot Stage 4 / EPA / CARB Tier 4 Final (non road). Fuel Tank Capacity: 400 l (105 gal)



Transmission

ZF-AS TRONIC automatic, 12 forward and 2 reverse speeds. Single speed transfer case with inter-axle differential lock.



Drive/Steer

6 x 4 x 6.



Axle lines

3 axle lines. Axle lines 1, 2 and 3 steered, 2 and 3 driven.



Suspension

MEGATRAK® all wheels with independent hydro pneumatic suspension and hydraulic lockout. Longitudinal and transverse level control with automatic on-highway leveling system.

Range +170 mm/-130 mm (+6.7 in / -5.1 in).



Tires

6 tires, 385/95 R25 (14.00 R25) Standard on/off road radial ply on steel rims.



Steering

Dual circuit, Servocom power steering with emergency steering pump. Separate steering of the 3rd axle line for all-wheel steering and crabbing.



Brakes

Service brake: pneumatic dual circuit, acting on all wheels, air dryer. Anti-lock braking system (ABS). Permanent brake: exhaust brake and constant throttle brake. Parking brake: pneumatically operated spring-loaded brake, acting on 1st and 3rd axle lines.



Cab

Aluminium, 2-person-design, safety glass, driver seat with pneumatic suspension, engine-dependent hot water heater. Complete instrumentation and driving controls. 60° tilt forward for engine access. Additional engine independent diesel cab heater, also serves as engine pre heater includes. 24 hour timer.



Electrical system

Three-phase alternator 28 V/100A, 2 batteries 12 V/170 Ah. Lighting system and signals 24 V.

* Optional equipment

- 6 x 6 x 6
- Electric driveline retarder
- 6 tires, 445/95 R25 (16.00 R25) - Vehicle width 2,75 m (9 ft)
- 6 tires, 525/80 R25 (20.5 R25) - Vehicle width 2,85 m (9.4 ft)
- Stainless steel exhaust system with spark arrester
- Air conditioning – combined system for both cabs
- Spare tire and wheel with carry bracket
- Engine shut down valve
- Outrigger pad load indicator
- Trailer hitch

Symbols glossary



Axles



Counterweight



Grade



Gear



Boom



Drive



Heavy duty jib



Radius



Boom elevation



Electrical system



Hoist



Rotation



Boom extension



Engine



Hookblock



Speed



Boom length



Extension



Hydraulic system



Steering



Boom nose



Frame



Lights



Suspension



Brakes



Fuel tank capacity



Oil



Swing



Cab



Outriggers



Outrigger controls



Tires



Transmission

Manitowoc Cranes

Regional headquarters

Americas

Milwaukee, Wisconsin, USA

Tel: +1 414 760 4600

Shady Grove, Pennsylvania, USA

Tel: +1 717 597 8121

Fax: +1 717 597 4062

Europe and Africa

Dardilly, France - TOWERS

Tel: +33 (0) 4 72 18 20 20

Fax: +33 (0) 4 72 18 20 00

Wilhelmshaven, Germany - MOBILE

Tel: +49 (0) 4421 294 0

Fax: +49 (0) 4421 294 4301

APAC

Shanghai, China

Tel: +86 21 6457 0066

Fax: +86 21 6457 4955

Singapore

Tel: +65 6264 1188

Fax: +65 6862 4040

Middle East and India

Dubai, UAE

Tel: +971 4 8862677

Fax: +971 4 8862678/79



This document is non-contractual. Constant improvement and engineering progress make it necessary that we reserve the right to make specification, equipment, and price changes without notice. Illustrations shown may include optional equipment and accessories and may not include all standard equipment.