



MAXIM
Crane Works, L.P.
1-877-MAX-LIFT

ALL TERRAIN CRANE

ATF 70G-4 | MAIN BOOM
144.4 ft

75 TON CAPACITY

**ALL
TERRAIN
CRANE**



Dimensions (ft, mm) / Dimensiones (ft, mm)

445/95 R 25
(16.00 R 25)

SAE

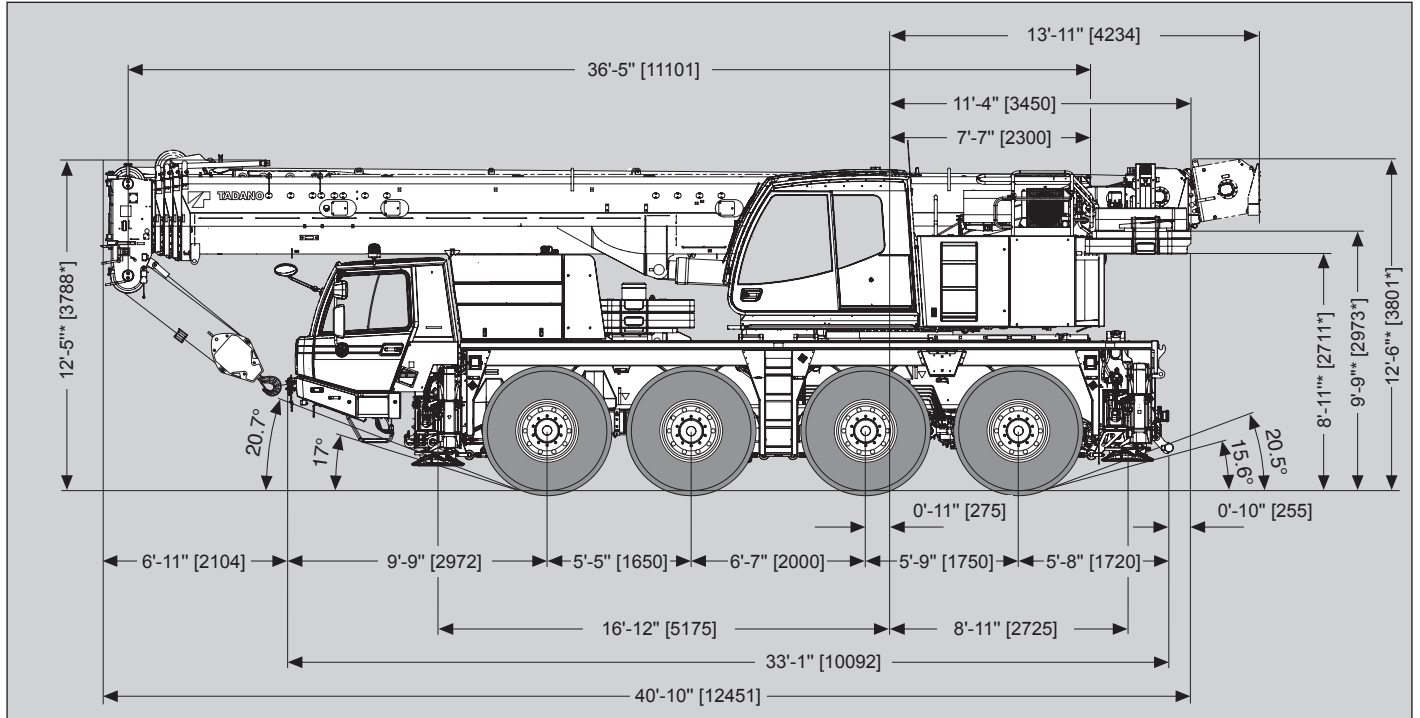

* ± 0'-4" [100]

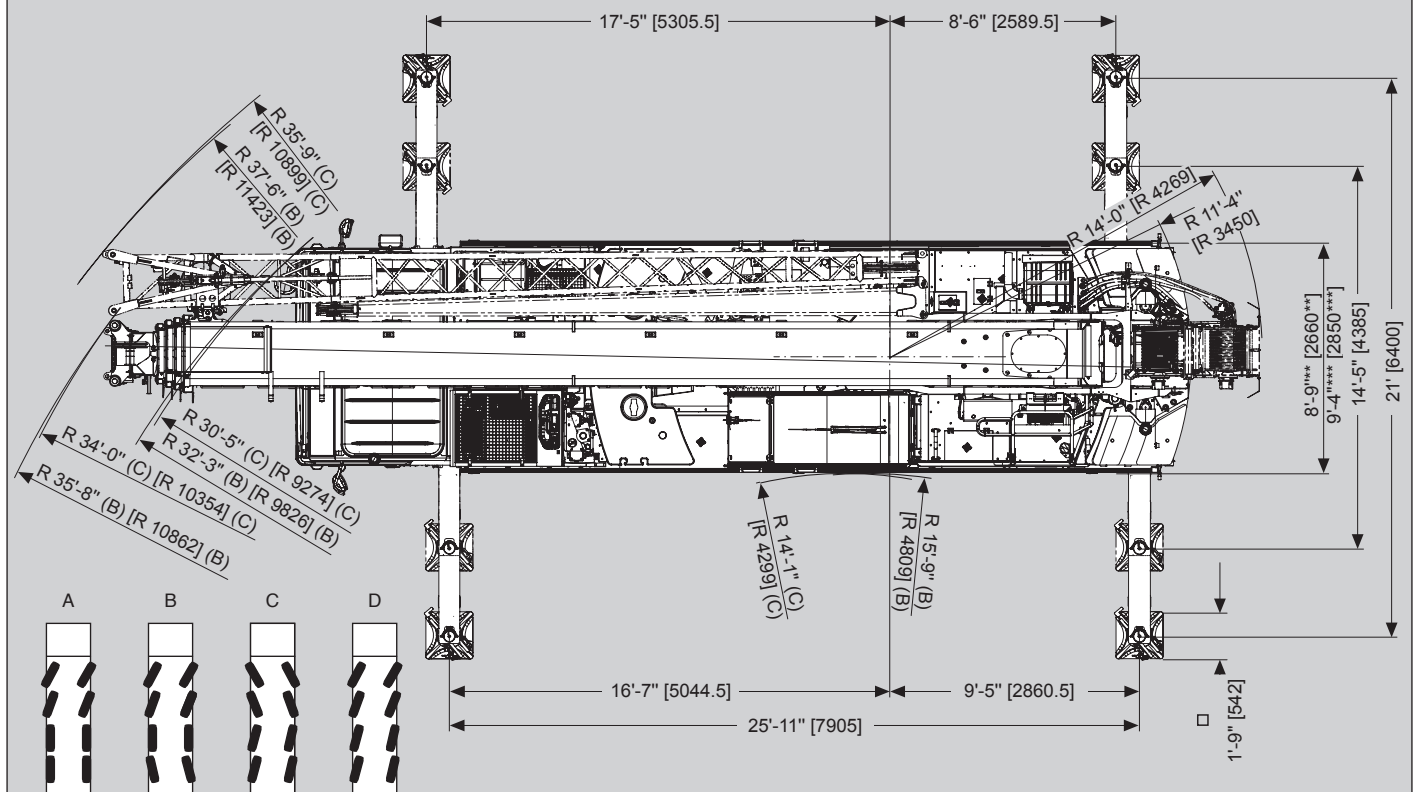



v > 15.5 mph < 15.5 mph
(25 km/h) (25 km/h)







** 445/95 R 25 (16.00 R 25)
*** 525/80 R 25 (20.50 R 25)







Weights / Working speeds / Pesos / Velocidades de trabajo



 	Lifting capacity Capacidad de elevación [lbs]	Sheaves Poleas	Part of line Ramales de cable	Weight Peso [lbs]
	* Rams horn * Gancho doble	104,500 (Type / Typo 50 ton)*	5	11
	67,241 (Type / Typo 32 ton)*	3	7	661
	67,241 (Type / Typo 32 ton)	3	7	661
	29,101 (Type / Typo 16 ton)	1	3	419
	9,921 (Type / Typo 6 ton)	-	1	331

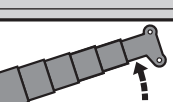
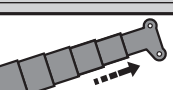

 	1	2	3	4	5	6	7	8	9	10	11	12	R1	R2	
	445/95 (16.00) mph	1.9	2.5	3.1	4.3	5.6	6.8	9.3	11.8	14.9	19.3	24.2	31.1	1.9	
	1.9	2.5	3.1	4.3	5.6	6.8	9.3	11.8	14.9	19.3	24.2	31.1	1.9	2.5	65%
	3.7	5.0	6.2	8.1	9.9	12.4	16.8	21.1	27.3	35.4	44.7	52.8	3.7	5.0	30%
525/80 (20.50) mph	1.9	2.5	3.1	4.3	5.6	6.8	9.3	11.8	14.9	19.3	24.2	31.1	1.9	2.5	65%
	1.9	2.5	3.1	4.3	5.6	6.8	9.3	11.8	14.9	19.3	24.2	31.1	1.9	2.5	65%
	3.7	5.0	6.2	8.1	9.9	12.4	16.8	21.1	27.3	35.4	44.7	52.8	3.7	5.0	30%

	Ininitely variable Infinitamente variable	Rope (diameter/length) Cable (diámetro/longitud)	Max. single line pull Trio máximo por ramal
	0 - 427 ft/min 0 - 130 m/min single line ramal simple	0.63"/ 673' 16 mm / 205 m	9,892 lbs 44 kN
	0 - 427 ft/min 0 - 130 m/min single line ramal simple	0.63"/ 673' 16 mm / 205 m	9,892 lbs 44 kN
	Max. permissible line pull may be affected by wire rope strength. which should not exceed 9,892 lbs for main winch and auxiliary winch La fuerza max del cabestrante es dependiente de la normativa en vigor. la cual no permite superar los 44 kN de fuerza.		
	0 - 2 rpm		0° and 180°
	-1.0° - +82°	approx. 33 s aproximadamente 33 s	
	36.4 ft - 144.4 ft 11.1 m - 44 m	approx. 320 s aproximadamente 320 s	

Lifting heights / Alturas de elevación

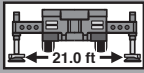
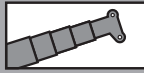



36,376 lbs

lbs x 1,000

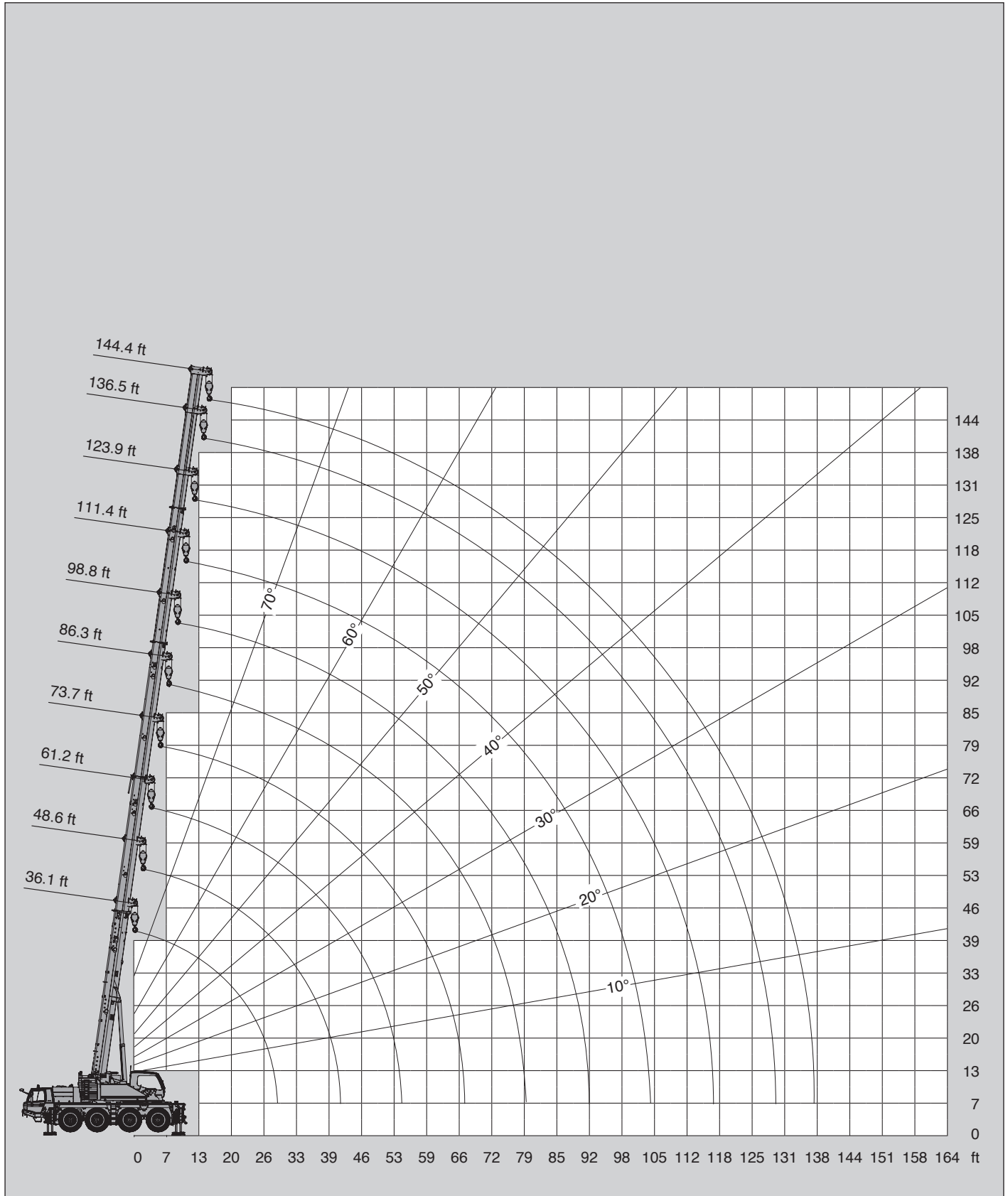

SAE

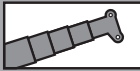
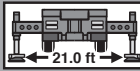

Lifting capacities / Capacidades de elevación

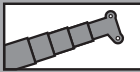
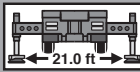

   36,376 lbs lbs x 1,000 SAE											
ft	36.1 ft*	36.1 ft	48.6 ft	61.2 ft	73.7 ft	86.3 ft	98.8 ft	111.4 ft	123.9 ft	136.5 ft	144.4 ft
8	154.3	127.9**									
10	131.4	120.8**	110.2	109.1							
12	120.8	111.1	103.6	99.9	93.3						
13	110.7	101.9	95.7	92.6	90.8	66.1					
15	97.7	92.2	88.8	86.0	84.2	66.1	54.0				
16	87.3	83.8	82.9	80.2	78.5	66.1	51.4	41.4			
20	71.6	70.5	71.0	70.3	69.2	63.5	46.5	41.4	31.3		
23	60.4	60.4	61.1	61.1	60.6	58.2	42.3	39.0	31.3	23.8	21.2
26	52.0	52.2	52.7	52.7	52.7	53.1	39.5	35.9	31.3	23.8	21.2
30			46.1	46.7	46.1	46.5	36.8	33.1	30.4	23.8	21.2
33			40.8	41.4	41.7	41.2	34.6	30.6	28.4	23.8	21.2
36			37.0	37.0	37.5	37.0	32.8	28.7	26.7	23.8	21.2
39			32.6	34.0	33.7	33.3	30.9	26.7	24.9	22.9	19.8
46				28.0	27.8	27.1	27.3	23.6	22.0	20.5	17.2
53				22.0	22.5	22.0	22.7	20.9	19.6	18.3	15.2
59					19.2	19.2	18.7	18.1	17.6	16.5	13.4
66					15.7	16.5	15.9	16.1	15.4	15.0	11.7
72						14.1	13.7	13.9	13.4	13.2	10.6
79							9.9	12.6	11.9	11.7	9.3
85								11.0	10.4	10.1	8.4
92									9.3	8.8	7.5
98									8.2	7.7	6.8
105										6.6	6.2
112									6.0	5.3	5.3
118										4.4	4.4
125										3.7	3.7
131											3.3

* Over rear / * Sobre la parte trasera ** With additional lifting equipment / ** Con equipo adicional

   26,896 lbs lbs x 1,000 SAE											
ft	36.1 ft*	36.1 ft	48.6 ft	61.2 ft	73.7 ft	86.3 ft	98.8 ft	111.4 ft	123.9 ft	136.5 ft	144.4 ft
8	154.3	127.9**									
10	131.4	120.8**	110.2	109.1							
12	120.8	110.2	103.6	99.9	93.3						
13	105.4	98.5	95.7	92.6	90.8	66.1					
15	93.0	88.8	88.8	86.0	84.2	66.1	54.0				
16	83.1	80.7	81.3	80.2	78.5	66.1	51.4	41.4			
20	68.1	67.7	68.3	67.9	67.9	63.5	46.5	41.4	31.3		
23	57.3	57.5	58.0	58.0	58.0	58.2	42.3	39.0	31.3	23.8	21.2
26	49.4	49.6	50.0	50.7	50.0	50.5	39.5	35.9	31.3	23.8	21.2
30			43.7	44.3	44.8	44.3	36.8	33.1	30.4	23.8	21.2
33			39.2	39.2	39.7	39.2	34.6	30.6	28.4	23.8	21.2
36			35.3	35.7	35.5	35.1	32.8	28.7	26.7	23.8	21.2
39			30.6	31.3	31.1	30.4	30.9	26.7	24.9	22.9	19.8
46				24.3	24.0	24.3	24.3	23.6	22.0	20.5	17.2
53				19.6	20.1	20.3	19.6	19.2	19.2	18.3	15.2
59					17.0	16.8	16.1	16.3	16.3	15.7	13.4
66					14.3	14.1	14.3	13.7	13.7	13.0	11.7
72						12.1	12.1	11.9	11.5	11.0	10.6
79							9.9	10.6	10.1	9.9	9.3
85								9.0	8.6	8.4	7.7
92									7.5	7.1	6.6
98									6.4	6.2	5.5
105										5.3	4.6
112										4.4	3.7
118											3.1
125											2.6
131											2.0

* Over rear / * Sobre la parte trasera ** With additional lifting equipment / ** Con equipo adicional

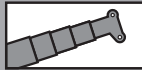
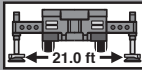
Lifting capacities / Capacidades de elevación

24,251 lbs

lbs x 1,000

SAE

ft	36.1 ft*	36.1 ft	48.6 ft	61.2 ft	73.7 ft	86.3 ft	98.8 ft	111.4 ft	123.9 ft	136.5 ft	144.4 ft
8	154.3	127.9**									
10	131.4	120.8**		109.1							
12	119.5	109.1	110.2	99.9	93.3						
13	103.8	97.7	95.7	92.6	90.8	66.1					
15	91.7	88.0	88.0	86.0	84.2	66.1	54.0				
16	82.0	79.8	80.5	79.8	78.5	66.1	51.4	41.4			
20	67.2	67.0	67.5	67.7	67.0	63.5	46.5	41.4	31.3		
23	56.7	56.7	57.1	57.3	57.3	57.8	42.3	39.0	31.3	23.8	21.2
26	48.7	48.7	49.2	49.8	49.4	49.8	39.5	35.9	31.3	23.8	21.2
30			43.0	43.7	44.1	43.7	36.8	33.1	30.4	23.8	21.2
33			38.8	39.0	39.0	38.6	34.6	30.6	28.4	23.8	21.2
36			33.7	34.4	34.2	33.5	32.8	28.7	26.7	23.8	21.2
39			29.1	29.8	29.5	28.9	29.3	26.7	24.9	22.9	19.8
46				23.1	23.6	23.1	23.1	22.3	22.0	20.5	17.2
53				18.7	19.0	19.2	18.5	19.0	18.1	18.3	15.2
59					16.1	15.9	16.1	15.4	15.4	14.8	13.4
66					13.7	13.2	13.4	13.2	12.8	12.3	11.7
72						11.5	11.5	11.2	10.8	10.4	10.4
79							9.9	9.5	9.3	8.6	8.6
85								8.6	8.2	7.1	7.1
92									6.8	6.6	6.0
98										6.0	6.0
105										5.5	5.1
112										4.9	4.2
118										4.0	3.3
125											2.9
131											2.2
											1.8

* Over rear / * Sobre la parte trasera ** With additional lifting equipment / ** Con equipo adicional





22,487 lbs



lbs x 1,000

SAE

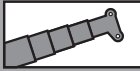
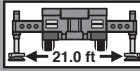

ft	36.1 ft*	36.1 ft	48.6 ft	61.2 ft	73.7 ft	86.3 ft	98.8 ft	111.4 ft	123.9 ft	136.5 ft	144.4 ft
8	154.3	127.9**									
10	131.4	120.8**	110.2	108.9							
12	118.4	108.5	103.4	99.9	93.3						
13	103.0	97.0	95.5	92.6	90.6	66.1					
15	90.8	87.3	87.7	86.0	84.2	66.1	54.0				
16	81.1	79.1	79.8	79.1	78.5	66.1	51.4	41.4			
20	66.6	66.4	66.8	67.0	66.4	63.3	46.3	41.4	31.3		
23	56.0	56.0	56.4	56.7	56.7	57.1	42.1	38.8	31.3	23.8	21.2
26	48.1	48.1	48.5	49.2	49.2	49.2	39.2	35.7	31.3	23.8	21.2
30			42.5	43.0	43.4	43.0	36.8	33.1	30.4	23.8	21.2
33			38.1	38.6	38.6	37.9	34.6	30.6	28.2	23.8	21.2
36			32.4	33.1	32.8	32.2	32.6	28.4	26.7	23.8	21.2
39			28.0	28.7	28.4	27.8	28.2	26.7	24.9	22.7	19.6
46				22.3	22.7	22.9	22.0	21.4	21.8	20.3	17.2
53				17.9	18.5	18.5	17.6	18.1	17.9	17.4	15.0
59					15.4	15.2	15.4	14.8	14.8	14.1	13.2
66						13.0	12.8	12.8	12.6	12.1	11.7
72							10.8	11.0	10.6	10.4	9.7
79								9.5	9.5	8.8	7.9
85									7.9	7.5	6.6
92										6.4	5.5
98										5.5	4.6
105											4.4
112											3.5
118											
125											
131											

* Over rear / * Sobre la parte trasera ** With additional lifting equipment / ** Con equipo adicional

Lifting capacities / Capacidades de elevación

   9,700 lbs lbs x 1,000 <div style="float: right; border: 1px solid black; padding: 2px;">SAE</div>											
ft	36.1 ft*	36.1 ft	48.6 ft	61.2 ft	73.7 ft	86.3 ft	98.8 ft	111.4 ft	123.9 ft	136.5 ft	144.4 ft
8	154.3	127.9**									
10	129.6	117.3**		109.1							
12	110.2	103.4	110.2	99.9	93.3						
13	95.7	92.2	92.8	92.2	90.8	66.1					
15	84.4	82.7	83.3	82.7	82.9	66.1	54.0				
16	75.4	74.7	75.4	75.4	75.0	66.1	51.4	41.4			
20	61.7	61.7	62.4	62.4	62.4	59.3	46.5	41.4	31.3		
23	50.9	52.0	52.5	53.1	51.8	47.8	42.3	39.0	31.3	23.8	21.2
26	39.7	41.9	43.9	44.8	42.8	39.7	38.4	35.9	31.3	23.8	21.2
30			35.3	35.9	35.7	34.6	33.3	30.6	30.0	23.8	21.2
33			29.1	29.8	29.8	29.8	28.7	27.1	26.0	23.8	21.2
36			24.5	25.1	25.6	26.0	25.1	24.7	23.6	22.0	21.2
39			20.9	21.8	22.7	22.3	22.3	21.8	20.9	19.4	19.2
46				16.5	17.4	17.2	17.4	17.0	16.8	15.7	15.2
53				13.2	13.9	13.7	13.9	13.4	13.2	12.6	12.3
59					11.2	11.0	11.2	10.8	10.6	9.9	9.9
66					9.3	9.0	9.3	8.8	8.4	7.9	7.9
72						7.5	7.5	7.1	6.8	6.2	6.2
79						6.2	6.2	5.7	5.5	4.9	4.9
85							5.3	4.6	4.4	3.7	3.7
92								3.7	3.5	2.9	2.9
98								3.1	2.6	2.2	2.2
105									2.2	1.5	1.5
112									1.5		

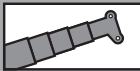
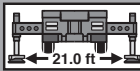
* Over rear / * Sobre la parte trasera ** With additional lifting equipment / ** Con equipo adicional

   7,496 lbs lbs x 1,000 <div style="float: right; border: 1px solid black; padding: 2px;">SAE</div>											
ft	36.1 ft*	36.1 ft	48.6 ft	61.2 ft	73.7 ft	86.3 ft	98.8 ft	111.4 ft	123.9 ft	136.5 ft	144.4 ft
8	154.3	127.9**									
10	127.9	116.2**	110.2	109.1							
12	108.9	102.5	102.3	99.9	93.3						
13	94.6	91.3	91.9	91.0	90.8	66.1					
15	83.3	81.8	82.5	81.8	82.0	66.1	54.0				
16	74.3	73.9	74.5	74.5	74.1	66.1	51.4	41.4			
20	60.8	60.8	61.5	61.5	59.3	56.2	46.5	41.4	31.3		
23	48.5	51.4	51.8	51.6	49.2	45.2	42.3	39.0	31.3	23.8	21.2
26	37.7	39.5	41.7	42.3	40.6	37.5	36.6	34.0	31.3	23.8	21.2
30			33.3	34.0	33.7	32.6	31.3	29.1	28.2	23.8	21.2
33			27.3	28.0	28.7	28.9	27.1	26.5	25.4	23.6	21.2
36			22.9	24.0	24.9	24.5	23.8	23.1	22.3	20.7	20.3
39			19.6	20.5	21.4	21.2	21.4	20.7	19.6	18.3	17.9
46				15.7	16.3	16.3	16.3	15.9	15.7	14.6	14.1
53				12.3	13.0	12.8	13.0	12.6	12.3	11.7	11.5
59					10.6	10.4	10.4	10.1	9.7	9.0	9.0
66					8.6	8.4	8.6	8.2	7.7	7.1	7.1
72						6.8	6.8	6.4	6.2	5.5	5.5
79						5.7	5.7	5.3	4.9	4.4	4.4
85							4.6	4.2	4.0	3.3	3.3
92								3.3	3.1	2.4	2.4
98								2.6	2.2	1.8	1.8
105									1.8		

* Over rear / * Sobre la parte trasera ** With additional lifting equipment / ** Con equipo adicional

Lifting heights / Alturas de elevación

		HYDRO		360°	36,376 lbs	lbs x 1,000	SAE
--	--	-------	--	------	------------	-------------	-----

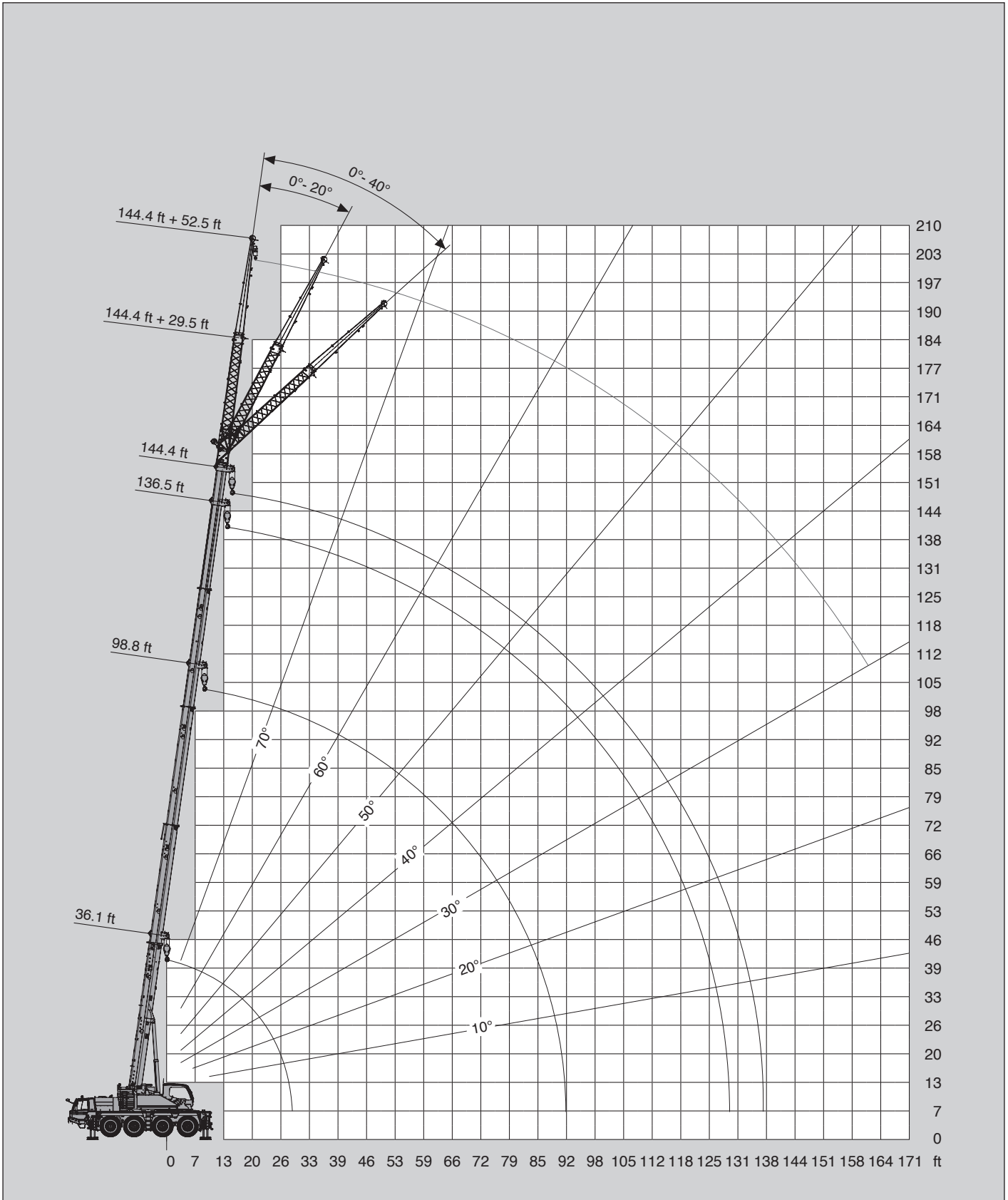

Lifting capacities / Capacidades de elevación







36,376 lbs

lbs x 1,000

SAE

ft	36.1 ft + 29.5 ft			98.8 ft + 29.5 ft			136.5 ft + 29.5 ft			144.4 ft + 29.5 ft		
	0°	20°	40°	0°	20°	40°	0°	20°	40°	0°	20°	40°
10	23.1*											
12	23.1*											
13	23.1*	23.1*										
15	23.1*	23.1*		23.1*								
16	23.1*	23.1*		23.1*								
20	23.1*	23.1*	19.8*	23.1*								
23	23.1*	22.3*	18.7	23.1*			13.2					
26	23.1*	20.9*	18.1	23.1*	19.2		13.2			11.9		
30	23.1*	20.1*	17.2	22.5*	18.1		13.2			11.9		
33	21.2*	19.2	16.5	21.2*	17.2	15.0	13.2			11.9		
36	19.6*	18.3	16.1	20.1*	16.5	14.3	13.2	12.6		11.9	11.9	
39	18.1	17.4	15.7	19.0	15.9	13.9	13.2	12.1		11.9	11.5	
46	15.7	15.9	15.0	17.2	14.6	13.0	12.1	11.5	10.4	11.5	10.8	10.1
53	13.9	15.0		15.9	13.7	12.3	11.2	10.6	9.9	10.6	10.1	9.5
59				14.6	12.8	11.7	10.4	9.9	9.3	9.7	9.5	8.8
66				13.2	12.1	11.0	9.5	9.3	8.8	9.0	8.8	8.4
72				11.9	11.5	10.6	8.8	8.6	8.4	8.2	8.2	7.9
79				10.8	10.8	10.1	8.4	8.2	7.9	7.3	7.3	7.5
85				9.5	9.9	9.9	7.7	7.5	7.5	6.6	6.6	6.6
92				7.9	8.4	8.8	7.1	7.1	7.1	5.7	6.0	6.0
98				6.8	7.1	7.3	6.4	6.6	6.6	5.1	5.3	5.5
105				5.7	6.0		5.7	6.0	6.2	4.4	4.9	4.9
112				4.9	5.1		4.9	5.3	5.5	4.0	4.2	4.4
118				4.0			4.2	4.4	4.6	3.5	3.7	4.0
125							3.5	3.7	4.0	3.1	3.3	3.3
131							2.9	3.1	3.1	2.6	2.9	2.9
138							2.2	2.4		2.2	2.4	2.4
144							1.8	2.0		1.8	2.0	
151							1.3	1.3		1.3	1.3	

* With additional lifting equipment / * Con equipo adicional

		 HYDRO	 21.0 ft	 360°	36,376 lbs	lbs x 1,000	SAE
---	---	---	---	--	-------------------	-------------	------------

 ft	36.1 ft + 52.5 ft			98.8 ft + 52.5 ft			136.5 ft + 52.5 ft			144.4 ft + 52.5 ft		
	0°	20°	40°	0°	20°	40°	0°	20°	40°	0°	20°	40°
10	17.4											
12	17.4											
13	17.4											
15	17.4											
16	17.4											
20	17.2			10.6								
23	16.1			10.6								
26	15.0	12.1		10.6			7.7					
30	14.1	11.5		10.6			7.7			7.3		
33	13.2	10.8		10.6			7.7			7.3		
36	12.3	10.4		10.6			7.7			7.3		
39	11.7	9.9	8.6	10.6	10.4		7.7			7.3		
46	10.6	9.0	8.2	10.6	9.7		7.7			7.3		
53	9.3	8.4	7.5	10.6	9.3	7.7	7.7	7.7		7.3		
59	8.2	7.7	7.3	10.6	8.8	7.5	7.7	7.7		7.3	7.3	
66	7.5	7.3	7.1	10.6	8.4	7.3	7.7	7.3		7.3	6.8	6.4
72	6.8	7.1	6.8	9.9	7.9	7.1	7.7	6.8	6.4	7.3	6.6	6.2
79	6.2	6.8		9.5	7.7	6.8	7.3	6.6	6.2	6.8	6.2	6.0
85				9.0	7.5	6.6	6.8	6.4	6.0	6.2	6.0	5.7
92				8.6	7.1	6.4	6.4	6.0	5.7	5.5	5.5	5.5
98				7.9	6.8	6.4	6.0	5.7	5.5	4.9	5.1	5.3
105				6.8	6.6	6.2	5.7	5.5	5.3	4.4	4.6	4.9
112				6.0	6.6	6.2	5.3	5.3	5.1	4.0	4.2	4.4
118				5.1	5.7		4.9	4.9	4.9	3.7	3.7	4.0
125				4.4	4.9		4.4	4.6	4.6	3.3	3.5	3.5
131				3.7	4.2		3.7	4.2	4.4	2.9	3.1	3.3
138				3.3	3.5		3.1	3.7	4.0	2.6	2.9	3.1
144				2.9			2.6	3.1	3.3	2.2	2.6	2.6
151							2.2	2.6	2.6	2.0	2.2	2.4
158							1.8	2.0		1.8	2.0	2.2
164								1.5			1.5	

Lifting capacities / Capacidades de elevación

26,896 lbs

lbs x 1,000

SAE

ft	36.1 ft + 29.5 ft			98.8 ft + 29.5 ft			136.5 ft + 29.5 ft			144.4 ft + 29.5 ft		
	0°	20°	40°	0°	20°	40°	0°	20°	40°	0°	20°	40°
10	23.1*											
12	23.1*											
13	23.1*	23.1*										
15	23.1*	23.1*		23.1*								
16	23.1*	23.1*		23.1*								
20	23.1*	23.1*	19.8*	23.1*								
23	23.1*	22.3*	18.7	23.1*			13.2					
26	23.1*	20.9*	18.1	23.1*	19.2		13.2			11.9		
30	23.1*	20.1*	17.2	22.5*	18.1		13.2			11.9		
33	21.2*	19.2	16.5	21.2*	17.2	15.0	13.2			11.9		
36	19.6*	18.3	16.1	20.1*	16.5	14.3	13.2	12.6		11.9	11.9	
39	18.1	17.4	15.7	19.0	15.9	13.9	13.2	12.1		11.9	11.5	
46	15.7	15.9	15.0	17.2	14.6	13.0	12.1	11.5	10.4	11.5	10.8	10.1
53	13.9	15.0		15.9	13.7	12.3	11.2	10.6	9.9	10.6	10.1	9.5
59				14.6	12.8	11.7	10.4	9.9	9.3	9.7	9.5	8.8
66				13.2	12.1	11.0	9.5	9.3	8.8	9.0	8.8	8.4
72				10.8	11.5	10.6	8.8	8.6	8.4	8.2	8.2	7.9
79				9.0	9.7	10.1	8.4	8.2	7.9	7.3	7.3	7.5
85				7.5	8.2	8.4	7.7	7.5	7.5	6.6	6.6	6.6
92				6.2	6.6	7.1	6.4	7.1	7.1	5.7	6.0	6.0
98				5.1	5.5	5.7	5.3	5.7	6.2	5.1	5.3	5.5
105				4.2	4.4		4.4	4.9	5.1	4.2	4.9	4.9
112				3.3	3.5		3.5	4.0	4.2	3.5	4.0	4.2
118				2.6			2.9	3.1	3.3	2.6	3.1	3.3
125							2.2	2.4	2.6	2.2	2.4	2.6
131							1.5	2.0	2.0	1.5	1.8	2.0
138							1.1	1.3			1.3	1.3

* With additional lifting equipment / * Con equipo adicional

ft	36.1 ft + 52.5 ft			98.8 ft + 52.5 ft			136.5 ft + 52.5 ft			144.4 ft + 52.5 ft		
	0°	20°	40°	0°	20°	40°	0°	20°	40°	0°	20°	40°
10	17.4											
12	17.4											
13	17.4											
15	17.4											
16	17.4											
20	17.2			10.6								
23	16.1			10.6								
26	15.0	12.1		10.6			7.7					
30	14.1	11.5		10.6			7.7			7.3		
33	13.2	10.8		10.6			7.7			7.3		
36	12.3	10.4		10.6			7.7			7.3		
39	11.7	9.9	8.6	10.6	10.4		7.7			7.3		
46	10.6	9.0	8.2	10.6	9.7		7.7			7.3		
53	9.3	8.4	7.5	10.6	9.3	7.7	7.7	7.7		7.3		
59	8.2	7.7	7.3	10.6	8.8	7.5	7.7	7.7		7.3	7.3	
66	7.5	7.3	7.1	10.6	8.4	7.3	7.7	7.3		7.3	6.8	6.4
72	6.8	7.1	6.8	9.9	7.9	7.1	7.7	6.8	6.4	7.3	6.6	6.2
79	6.2	6.8		9.5	7.7	6.8	7.3	6.6	6.2	6.8	6.2	6.0
85				8.8	7.5	6.6	6.8	6.4	6.0	6.2	6.0	5.7
92				7.5	7.1	6.4	6.4	6.0	5.7	5.5	5.5	5.5
98				6.4	6.8	6.4	6.0	5.7	5.5	4.9	5.1	5.3
105				5.5	6.2	6.2	5.3	5.5	5.3	4.4	4.6	4.9
112				4.6	5.3	5.5	4.4	5.3	5.1	4.0	4.2	4.4
118				3.7	4.4		3.7	4.4	4.9	3.7	3.7	4.0
125				3.3	3.7		3.1	3.7	4.2	3.1	3.5	3.5
131				2.6	2.9		2.6	3.1	3.5	2.4	3.1	3.3
138				2.2	2.4		2.0	2.4	2.9	2.0	2.4	2.9
144				1.8			1.5	2.0	2.2	1.5	2.0	2.2
151							1.1	1.5	1.8		1.5	1.8
158								1.1				1.3

Lifting capacities / Capacidades de elevación

24,251 lbs

lbs x 1,000

SAE

ft	36.1 ft + 29.5 ft			98.8 ft + 29.5 ft			136.5 ft + 29.5 ft			144.4 ft + 29.5 ft		
	0°	20°	40°	0°	20°	40°	0°	20°	40°	0°	20°	40°
10	23.1*											
12	23.1*											
13	23.1*	23.1*										
15	23.1*	23.1*		23.1*								
16	23.1*	23.1*		23.1*								
20	23.1*	23.1*	19.8*	23.1*								
23	23.1*	22.3*	18.7	23.1*			13.2					
26	23.1*	20.9*	18.1	23.1*	19.2		13.2			11.9		
30	23.1*	20.1*	17.2	22.5*	18.1		13.2			11.9		
33	21.2*	19.2	16.5	21.2*	17.2	15.0	13.2			11.9		
36	19.6*	18.3	16.1	20.1*	16.5	14.3	13.2	12.6		11.9	11.9	
39	18.1	17.4	15.7	19.0	15.9	13.9	13.2	12.1		11.9	11.5	
46	15.7	15.9	15.0	17.2	14.6	13.0	12.1	11.5	10.4	11.5	10.8	10.1
53	13.9	15.0		15.9	13.7	12.3	11.2	10.6	9.9	10.6	10.1	9.5
59				14.6	12.8	11.7	10.4	9.9	9.3	9.7	9.5	8.8
66				12.3	12.1	11.0	9.5	9.3	8.8	9.0	8.8	8.4
72				10.1	11.0	10.6	8.8	8.6	8.4	8.2	8.2	7.9
79				8.4	9.0	9.5	8.4	8.2	7.9	7.3	7.3	7.5
85				6.8	7.5	7.7	7.1	7.5	7.5	6.6	6.6	6.6
92				5.7	6.2	6.4	5.7	6.4	6.8	5.7	6.0	6.0
98				4.6	5.1	5.1	4.9	5.3	5.7	4.6	5.3	5.5
105				3.7	4.0		3.7	4.4	4.6	3.7	4.2	4.6
112				2.9	3.1		3.1	3.5	3.7	3.1	3.5	3.7
118				2.2			2.4	2.6	2.9	2.2	2.6	2.9
125							1.8	2.2	2.2	1.8	2.0	2.2
131							1.3	1.5	1.5	1.1	1.5	1.5

* With additional lifting equipment / * Con equipo adicional

ft	36.1 ft + 52.5 ft			98.8 ft + 52.5 ft			136.5 ft + 52.5 ft			144.4 ft + 52.5 ft		
	0°	20°	40°	0°	20°	40°	0°	20°	40°	0°	20°	40°
10	17.4											
12	17.4											
13	17.4											
15	17.4											
16	17.4											
20	17.2			10.6								
23	16.1			10.6								
26	15.0	12.1		10.6			7.7					
30	14.1	11.5		10.6			7.7			7.3		
33	13.2	10.8		10.6			7.7			7.3		
36	12.3	10.4		10.6			7.7			7.3		
39	11.7	9.9	8.6	10.6	10.4		7.7			7.3		
46	10.6	9.0	8.2	10.6	9.7		7.7			7.3		
53	9.3	8.4	7.5	10.6	9.3	7.7	7.7	7.7		7.3		
59	8.2	7.7	7.3	10.6	8.8	7.5	7.7	7.7		7.3	7.3	
66	7.5	7.3	7.1	10.6	8.4	7.3	7.7	7.3		7.3	6.8	6.4
72	6.8	7.1	6.8	9.9	7.9	7.1	7.7	6.8	6.4	7.3	6.6	6.2
79	6.2	6.8		9.5	7.7	6.8	7.3	6.6	6.2	6.8	6.2	6.0
85				8.2	7.5	6.6	6.8	6.4	6.0	6.2	6.0	5.7
92				6.8	7.1	6.4	6.4	6.0	5.7	5.5	5.5	5.5
98				6.0	6.6	6.4	5.7	5.7	5.5	4.9	5.1	5.3
105				4.9	5.7	6.2	4.9	5.5	5.3	4.4	4.6	4.9
112				4.2	4.9	5.1	4.0	4.9	5.1	4.0	4.2	4.4
118				3.5	4.0		3.3	4.0	4.6	3.3	3.7	4.0
125				2.9	3.3		2.6	3.3	3.7	2.6	3.3	3.5
131				2.2	2.6		2.2	2.6	3.1	2.0	2.6	3.1
138				1.8	2.0		1.8	2.2	2.4	1.5	2.2	2.4
144				1.3			1.3	1.8	2.0	1.1	1.5	2.0
151								1.1	1.3		1.1	1.3

Lifting capacities / Capacidades de elevación

		HYDRO	21.0 ft	360°	22,487 lbs	lbs x 1,000	SAE
--	--	-------	---------	------	-------------------	-------------	------------

ft	36.1 ft + 29.5 ft			98.8 ft + 29.5 ft			136.5 ft + 29.5 ft			144.4 ft + 29.5 ft		
	0°	20°	40°	0°	20°	40°	0°	20°	40°	0°	20°	40°
10	23.1*											
12	23.1*											
13	23.1*	23.1*										
15	23.1*	23.1*		23.1*								
16	23.1*	23.1*		23.1*								
20	23.1*	23.1*	19.8*	23.1*								
23	23.1*	22.3*	18.7	23.1*			13.2					
26	23.1*	20.9*	18.1	23.1*	19.2		13.2			11.9		
30	23.1*	20.1*	17.2	22.5*	18.1		13.2			11.9		
33	21.2*	19.2	16.5	21.2*	17.2	15.0	13.2			11.9		
36	19.6*	18.3	16.1	20.1*	16.5	14.3	13.2	12.6		11.9	11.9	
39	18.1	17.4	15.7	19.0	15.9	13.9	13.2	12.1		11.9	11.5	
46	15.7	15.9	15.0	17.2	14.6	13.0	12.1	11.5	10.4	11.5	10.8	10.1
53	13.9	15.0		15.9	13.7	12.3	11.2	10.6	9.9	10.6	10.1	9.5
59				14.3	12.8	11.7	10.4	9.9	9.3	9.7	9.5	8.8
66				11.7	12.1	11.0	9.5	9.3	8.8	9.0	8.8	8.4
72				9.7	10.4	10.6	8.8	8.6	8.4	8.2	8.2	7.9
79				7.9	8.6	9.0	7.9	8.2	7.9	7.3	7.3	7.5
85				6.4	7.1	7.5	6.6	7.3	7.5	6.4	6.6	6.6
92				5.3	5.7	6.0	5.5	6.0	6.4	5.3	6.0	6.0
98				4.2	4.6	4.9	4.4	4.9	5.3	4.4	4.9	5.3
105				3.3	3.7		3.5	4.0	4.4	3.5	4.0	4.2
112				2.6	2.9		2.6	3.1	3.5	2.6	3.1	3.3
118				2.0			2.2	2.4	2.6	2.0	2.4	2.6
125							1.5	1.8	2.0	1.3	1.8	2.0
131								1.3	1.3		1.1	1.3

* With additional lifting equipment / * Con equipo adicional

ft	36.1 ft + 52.5 ft			98.8 ft + 52.5 ft			136.5 ft + 52.5 ft			144.4 ft + 52.5 ft		
	0°	20°	40°	0°	20°	40°	0°	20°	40°	0°	20°	40°
10	17.4											
12	17.4											
13	17.4											
15	17.4											
16	17.4											
20	17.2			10.6								
23	16.1			10.6								
26	15.0	12.1		10.6			7.7					
30	14.1	11.5		10.6			7.7			7.3		
33	13.2	10.8		10.6			7.7			7.3		
36	12.3	10.4		10.6			7.7			7.3		
39	11.7	9.9	8.6	10.6	10.4		7.7			7.3		
46	10.6	9.0	8.2	10.6	9.7		7.7			7.3		
53	9.3	8.4	7.5	10.6	9.3	7.7	7.7	7.7		7.3		
59	8.2	7.7	7.3	10.6	8.8	7.5	7.7	7.7		7.3	7.3	
66	7.5	7.3	7.1	10.6	8.4	7.3	7.7	7.3		7.3	6.8	6.4
72	6.8	7.1	6.8	9.9	7.9	7.1	7.7	6.8	6.4	7.3	6.6	6.2
79	6.2	6.8		9.3	7.7	6.8	7.3	6.6	6.2	6.8	6.2	6.0
85				7.7	7.5	6.6	6.8	6.4	6.0	6.2	6.0	5.7
92				6.6	7.1	6.4	6.4	6.0	5.7	5.5	5.5	5.5
98				5.5	6.4	6.4	5.3	5.7	5.5	4.9	5.1	5.3
105				4.6	5.3	5.7	4.6	5.3	5.3	4.4	4.6	4.9
112				3.7	4.4	4.9	3.7	4.6	5.1	3.5	4.2	4.4
118				3.1	3.7		3.1	3.7	4.2	2.9	3.7	4.0
125				2.4	2.9		2.4	3.1	3.5	2.4	3.1	3.5
131				2.0	2.4		2.0	2.4	2.9	1.8	2.4	2.9
138				1.5	1.8		1.3	2.0	2.2	1.3	1.8	2.2
144								1.5	1.8		1.3	1.8
151									1.1			1.1

Lifting capacities / Capacidades de elevación

9,700 lbs

lbs x 1,000

SAE

ft	36.1 ft + 29.5 ft			98.8 ft + 29.5 ft			136.5 ft + 29.5 ft			144.4 ft + 29.5 ft		
	0°	20°	40°	0°	20°	40°	0°	20°	40°	0°	20°	40°
10	23.1*											
12	23.1*											
13	23.1*	23.1*										
15	23.1*	23.1*		23.1*								
16	23.1*	23.1*		23.1*								
20	23.1*	23.1*	19.8*	23.1*								
23	23.1*	22.3*	18.7	23.1*			13.2					
26	23.1*	20.9*	18.1	23.1*	19.2		13.2			11.9		
30	23.1*	20.1*	17.2	22.5*	18.1		13.2			11.9		
33	21.2*	19.2	16.5	21.2*	17.2	15.0	13.2			11.9		
36	19.6*	18.3	16.1	20.1*	16.5	14.3	13.2	12.6		11.9	11.9	
39	18.1	17.4	15.7	19.0	15.9	13.9	13.2	12.1		11.9	11.5	
46	15.7	15.9	15.0	14.8	14.6	13.0	12.1	11.5	10.4	11.5	10.8	10.1
53	13.9	15.0		11.9	13.2	12.3	11.0	10.6	9.9	10.6	10.1	9.5
59				9.5	10.6	11.5	8.8	9.9	9.3	8.6	9.5	8.8
66				7.5	8.6	9.3	7.1	8.2	8.8	6.8	7.9	8.4
72				6.0	6.8	7.3	5.7	6.6	7.3	5.5	6.4	7.1
79				4.6	5.3	5.7	4.4	5.3	5.7	4.2	5.1	5.7
85				3.5	4.0	4.4	3.5	4.2	4.6	3.3	4.0	4.4
92				2.4	2.9	3.3	2.6	3.1	3.5	2.4	3.1	3.5
98				1.8	2.0	2.2	1.8	2.4	2.6	1.8	2.2	2.6
105					1.3		1.1	1.5	2.0		1.5	1.8
112									1.1			

* With additional lifting equipment / * Con equipo adicional

ft	36.1 ft + 52.5 ft			98.8 ft + 52.5 ft			136.5 ft + 52.5 ft			144.4 ft + 52.5 ft		
	0°	20°	40°	0°	20°	40°	0°	20°	40°	0°	20°	40°
10	17.4											
12	17.4											
13	17.4											
15	17.4											
16	17.4											
20	17.2			10.6								
23	16.1			10.6								
26	15.0	12.1		10.6			7.7					
30	14.1	11.5		10.6			7.7			7.3		
33	13.2	10.8		10.6			7.7			7.3		
36	12.3	10.4		10.6			7.7			7.3		
39	11.7	9.9	8.6	10.6	10.4		7.7			7.3		
46	10.6	9.0	8.2	10.6	9.7		7.7			7.3		
53	9.3	8.4	7.5	10.6	9.3	7.7	7.7	7.7		7.3		
59	8.2	7.7	7.3	10.4	8.8	7.5	7.7	7.7		7.3	7.3	
66	7.5	7.3	7.1	8.6	8.4	7.3	7.7	7.3		7.3	6.8	6.4
72	6.8	7.1	6.8	7.1	7.9	7.1	6.4	6.8	6.4	6.2	6.6	6.2
79	6.2	6.8		5.7	7.1	6.8	5.3	6.6	6.2	5.1	6.2	6.0
85				4.9	6.0	6.6	4.2	5.5	6.0	4.0	5.3	5.7
92				3.7	4.9	5.5	3.3	4.4	5.3	3.3	4.4	5.3
98				2.9	3.7	4.4	2.6	3.5	4.4	2.4	3.5	4.2
105				2.2	2.9	3.5	2.0	2.9	3.5	1.8	2.6	3.5
112				1.5	2.2	2.6	1.5	2.2	2.9		2.0	2.6
118					1.5			1.5	2.2			2.0
125									1.5			

Lifting capacities / Capacidades de elevación

7,496 lbs

lbs x 1,000

SAE

ft	36.1 ft + 29.5 ft			98.8 ft + 29.5 ft			136.5 ft + 29.5 ft			144.4 ft + 29.5 ft		
	0°	20°	40°	0°	20°	40°	0°	20°	40°	0°	20°	40°
10	23.1*											
12	23.1*											
13	23.1*	23.1*										
15	23.1*	23.1*		23.1*								
16	23.1*	23.1*		23.1*								
20	23.1*	23.1*	19.8*	23.1*								
23	23.1*	22.3*	18.7	23.1*			13.2					
26	23.1*	20.9*	18.1	23.1*	19.2		13.2			11.9		
30	23.1*	20.1*	17.2	22.5*	18.1		13.2			11.9		
33	21.2*	19.2	16.5	21.2*	17.2	15.0	13.2			11.9		
36	19.6*	18.3	16.1	20.1*	16.5	14.3	13.2	12.6		11.9	11.9	
39	18.1	17.4	15.7	17.6	15.9	13.9	13.2	12.1		11.9	11.5	
46	15.7	15.9	15.0	13.9	14.6	13.0	12.1	11.5	10.4	11.5	10.8	10.1
53	13.9	15.0		10.8	12.1	12.3	10.1	10.6	9.9	9.7	10.1	9.5
59				8.6	9.7	10.6	7.9	9.0	9.3	7.7	8.8	8.8
66				6.8	7.7	8.6	6.4	7.3	8.2	6.2	7.1	7.9
72				5.3	6.2	6.8	5.1	6.0	6.6	4.9	5.7	6.4
79				4.0	4.6	5.1	4.0	4.6	5.3	3.7	4.4	5.1
85				2.9	3.5	4.0	2.9	3.5	4.2	2.6	3.3	4.0
92				2.0	2.4	2.6	2.0	2.6	3.1	2.0	2.4	2.9
98				1.3	1.5	1.8	1.3	2.0	2.2		1.8	2.2
105									1.5			1.3

* With additional lifting equipment / * Con equipo adicional

ft	36.1 ft + 52.5 ft			98.8 ft + 52.5 ft			136.5 ft + 52.5 ft			144.4 ft + 52.5 ft		
	0°	20°	40°	0°	20°	40°	0°	20°	40°	0°	20°	40°
10	17.4											
12	17.4											
13	17.4											
15	17.4											
16	17.4											
20	17.2			10.6								
23	16.1			10.6								
26	15.0	12.1		10.6			7.7					
30	14.1	11.5		10.6			7.7			7.3		
33	13.2	10.8		10.6			7.7			7.3		
36	12.3	10.4		10.6			7.7			7.3		
39	11.7	9.9	8.6	10.6	10.4		7.7			7.3		
46	10.6	9.0	8.2	10.6	9.7		7.7			7.3		
53	9.3	8.4	7.5	10.6	9.3	7.7	7.7	7.7		7.3		
59	8.2	7.7	7.3	9.7	8.8	7.5	7.7	7.7		7.3	7.3	
66	7.5	7.3	7.1	7.9	8.4	7.3	7.1	7.3		6.8	6.8	6.4
72	6.8	7.1	6.8	6.4	7.7	7.1	5.7	6.8	6.4	5.5	6.6	6.2
79	6.2	6.8		5.3	6.4	6.8	4.6	6.0	6.2	4.4	5.7	6.0
85				4.2	5.3	6.2	3.7	4.9	6.0	3.5	4.6	5.7
92				3.3	4.2	5.1	2.9	4.0	4.9	2.6	3.7	4.6
98				2.4	3.3	4.0	2.2	3.1	4.0	2.0	2.9	3.7
105				1.8	2.4	3.1	1.5	2.4	3.1		2.2	3.1
112				1.1	1.8	2.2		1.8	2.4			2.2
118					1.1				1.8			1.5

Lifting heights / Alturas de elevación

Lifting capacities / Capacidades de elevación



36,376 lbs lbs x 1,000 **SAE**



36,376 lbs lbs x 1,000 **SAE**

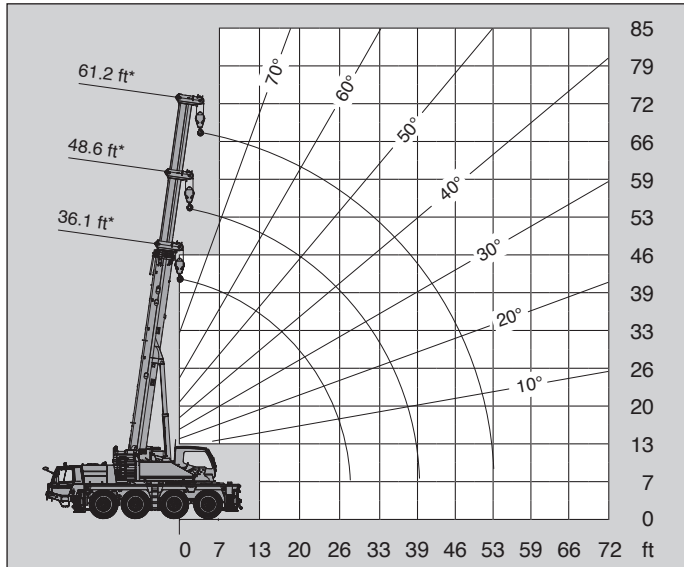

* Superstructure locked / * Bloqueo de superestructura

ft	36.1 ft	48.6 ft	61.2 ft
10	46.5	47.2	47.6
12	42.3	43.0	43.4
13	38.8	39.5	39.9
15	35.5	36.4	36.8
16	32.8	33.7	34.2
20	28.2	29.1	29.1
23	22.9	24.0	24.7
26	18.7	19.8	20.5
30		16.8	17.4
33		14.1	14.8
36		12.1	12.8
39		10.6	11.0
46			8.6
53			6.6



26,896 lbs lbs x 1,000 **SAE**



24,251 lbs lbs x 1,000 **SAE**

ft	36.1 ft	48.6 ft	61.2 ft
10	47.0	47.6	47.4
12	42.5	43.4	41.7
13	39.0	39.0	36.8
15	35.9	34.6	33.1
16	32.0	31.1	29.8
20	24.5	25.6	24.7
23	19.6	20.7	20.9
26	15.9	17.0	17.6
30		14.1	14.8
33		11.9	12.6
36		10.1	10.8
39		8.6	9.3
46			6.8
53			5.3

ft	36.1 ft	48.6 ft	61.2 ft
10	47.0	47.8	45.4
12	42.8	42.3	39.7
13	39.0	37.3	35.3
15	34.6	33.1	31.5
16	30.4	29.8	28.4
20	23.4	24.3	23.6
23	18.5	19.6	19.8
26	15.0	16.1	16.8
30		13.4	14.1
33		11.2	11.9
36		9.5	10.1
39		8.2	8.6
46			6.4
53			4.9

Lifting heights / Alturas de elevación

Lifting capacities / Capacidades de elevación



22,487 lbs lbs x 1,000 **SAE**



22,487 lbs lbs x 1,000 **SAE**

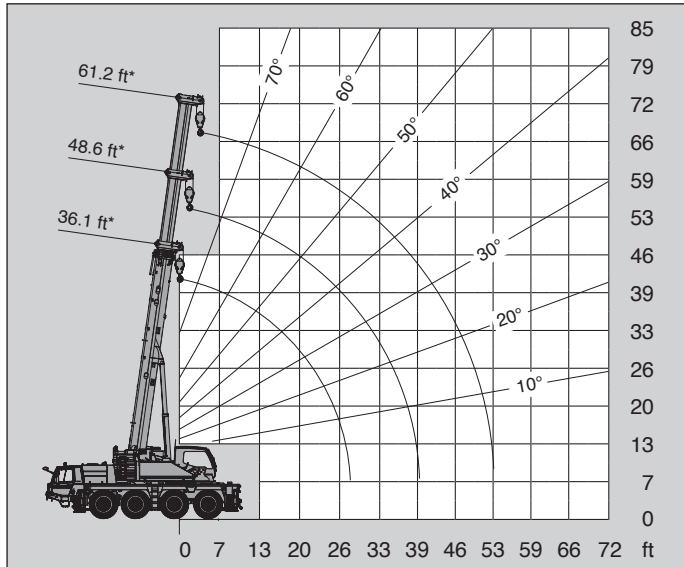

ft	36.1 ft	48.6 ft	61.2 ft
10	47.0	47.4	43.9
12	42.8	41.0	38.6
13	37.9	36.2	34.2
15	33.5	32.0	30.4
16	29.3	28.7	27.6
20	22.5	23.4	22.7
23	17.9	19.0	19.2
26	14.3	15.4	16.1
30		12.8	13.4
33		10.8	11.5
36		9.0	9.7
39		7.7	8.2
46			6.2
53			4.6



9,700 lbs lbs x 1,000 **SAE**



7,496 lbs lbs x 1,000 **SAE**

ft	36.1 ft	48.6 ft	61.2 ft
10	39.2	36.6	34.2
12	33.3	31.5	29.8
13	28.7	27.6	26.2
15	25.1	24.3	23.1
16	22.0	21.6	20.7
20	16.5	17.4	17.0
23	12.6	13.9	14.1
26	9.9	11.0	11.7
30		9.0	9.5
33		7.3	7.9
36		6.0	6.6
39		4.9	5.3
46			3.5
53			2.4

ft	36.1 ft	48.6 ft	61.2 ft
10	37.0	34.8	32.4
12	31.5	30.0	28.2
13	27.1	26.0	24.7
15	23.6	22.9	22.0
16	20.7	20.3	19.6
20	15.4	16.3	15.9
23	11.7	13.0	13.2
26	9.0	10.4	11.0
30		8.2	8.8
33		6.6	7.3
36		5.3	6.0
39		4.2	4.9
46			3.3
53			2.0

Axle weight distribution chart / Distribución de pesos por ejes

Axle Eje	1	2	3	4	Total weight Peso total
Tires 525/80 R 25 (20.50 R 25) [lbs]	23,954	23,616	17,489	17,285	82,345*

Boom to front	Total [lbs]	Axle 1 [lbs]	Axle 2 [lbs]	Axle 3 [lbs]	Axle 4 [lbs]
Base machine with equipment for USA, 16.00 R 25 tires, 8 x 6 drive, additional cabine heater, air condition in carrier and upperstructure, reversing camera, no counterweight, no fuel, no driver	73,048	20,880	21,006	15,731	15,432
* Fuel in carrier	815	-120	-133	530	538
* Fuel in superstructure	379	-31	-37	221	225
* Driver in carrier	198	192	192	-95	-90
* 6.6 ton [6.0 t]** headache ball between axle 2 and 3	328	86	84	77	82
35.3 ton [32.0 t]** (3 sheaves) hook block in front (at bumper)	664	745	750	-423	-408
29.5 ft / 52.5 ft Mechanical offset boom extension	2,879	1,936	1,931	-516	-472
* 29.5 ft / 52.5 ft Hydraulic offset boom extension	3,856	2,815	2,813	-917	-855
* Auxiliary winch with cable	1,616	-683	-721	1,506	1,515
* Auxiliary boom point sheave (single top)	110	143	143	-90	-86
* 2 nd oil cooler	101	-9	-9	60	60
* Drive 8 x 8	661	529	132	0	0
* 20.50 R 25 tires in lieu of 16.00 R 25 tires	1,023	256	256	256	256
Eddy-current brake	516	31	31	-7	461
* Tool box at rear	152	-57	-60	134	134

* Basic configuration, marked items are included

Counterweight at the upper:					
Counterweight 1+2: 1,808 lbs [0.8 t]**	1,808	-558	-593	1,473	1,486
Counterweight 3+3+4: 5,620 lbs [2.6 t]**	5,620	-1,720	-1,834	4,568	4,605
Counterweight 5 (No. 1): 5,051 lbs [2.3 t]**	5,051	-1,550	-1,649	4,109	4,142
Counterweight 5 (No. 2): 5,051 lbs [2.3 t]**	5,051	-1,550	-1,649	4,109	4,142
Counterweight 8: 2,258 lbs [1.0 t]**	2,258	-692	-736	1,834	1,852
Counterweight 7: (No. 1) 4,384 lbs [2.0 t]**	4,384	-1,343	-1,431	3,563	3,593
Counterweight 7: (No. 2) 4,384 lbs [2.0 t]**	4,384	-1,343	-1,431	3,563	3,593
Counterweight 6: 7,648 lbs [3.5 t]**	7,648	-2,341	-2,496	6,217	6,268

Counterweight on the carrier:					
Counterweight 5 (No. 1): 5,051 lbs [2.3 t]**	5,051	2,429	2,401	75	146
Counterweight 5 (No. 2): 5,051 lbs [2.3 t]**	5,051	2,429	2,401	75	146
Counterweight 8: 2,258 lbs [1.0 t]**	2,258	1,087	1,074	33	66
Counterweight 7: (No. 1) 4,384 lbs [2.0 t]**	4,384	2,108	2,083	66	128
Counterweight 7: (No. 2) 4,384 lbs [2.0 t]**	4,384	2,108	2,083	66	128
Counterweight 6: 7,648 lbs [3.5 t]**	7,648	3,677	3,635	115	220

** Metric

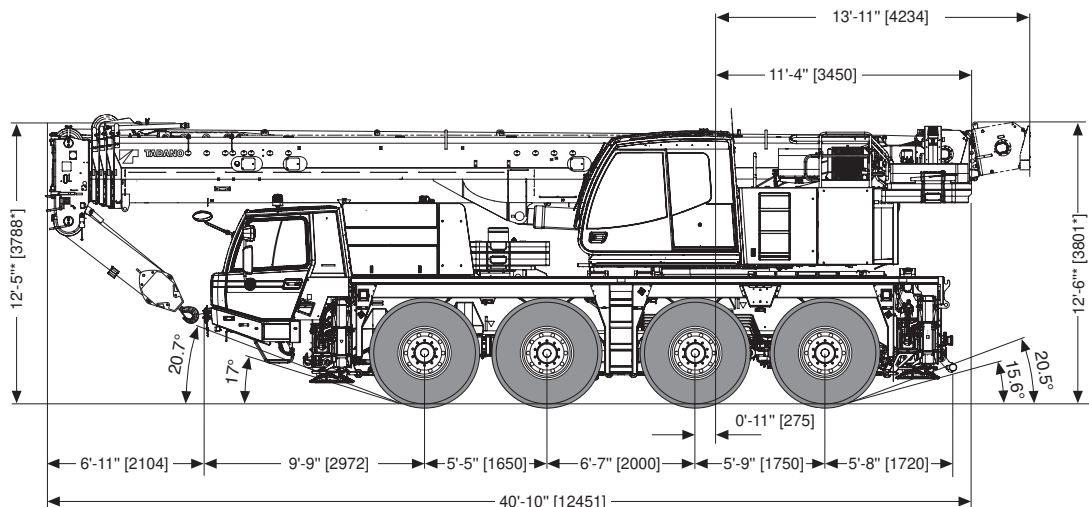

Counterweight versions / Variaciones de contrapeso

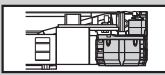
 Counterweight Contrapeso	1x	1x	2x	1x	2x	1x	2x	1x
	①	②	③	④	⑤	⑥	⑦	⑧
[lbs]	661	1,102	1,764	2,205	5,071	7,716	4,409	2,205

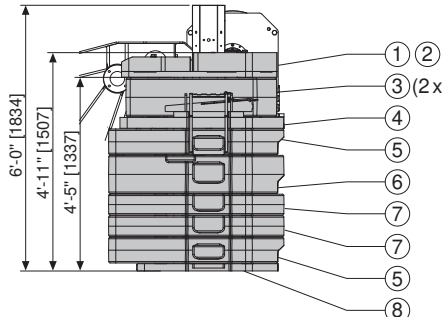
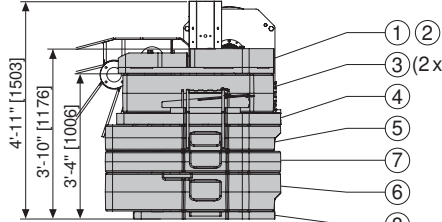
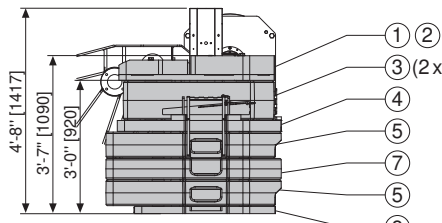
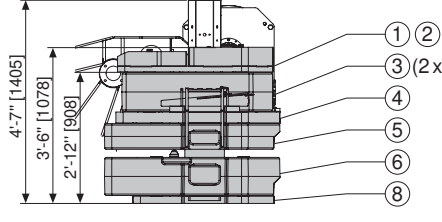
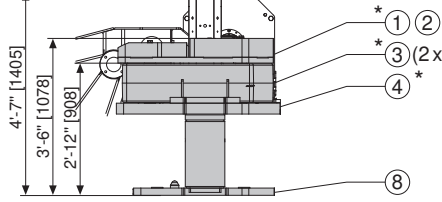
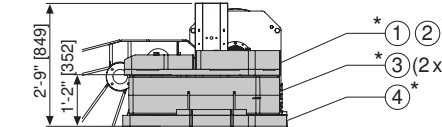
36,376 lbs	
26,896 lbs	
24,251 lbs	
22,487 lbs	
9,700 lbs	
7,496 lbs	

* Denotes cwt's requiring assist vehicle unless appropriate cwt configuration is used to erect

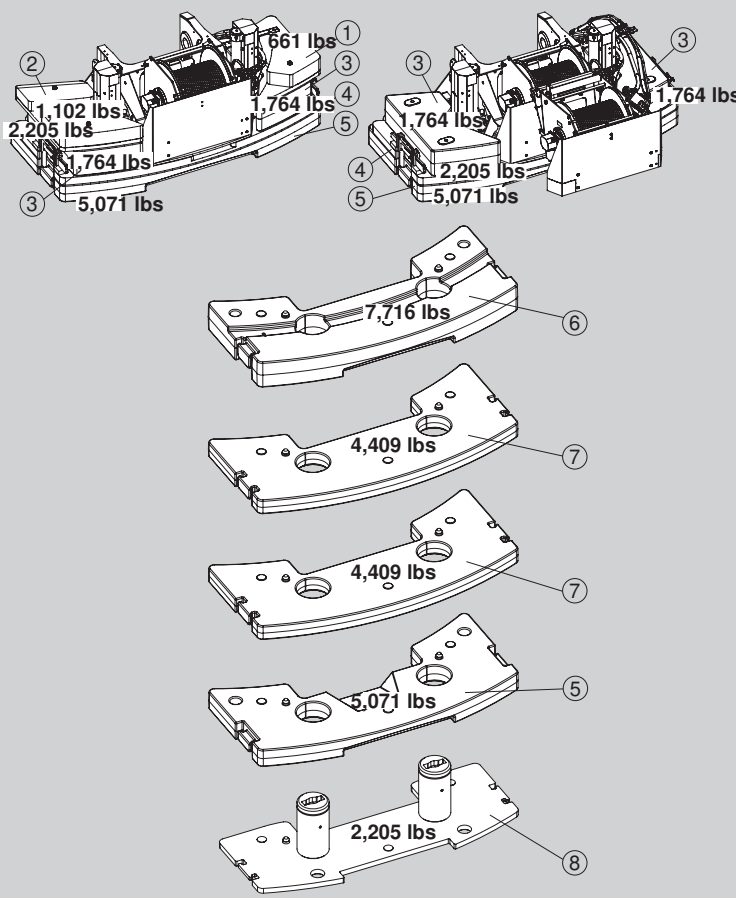
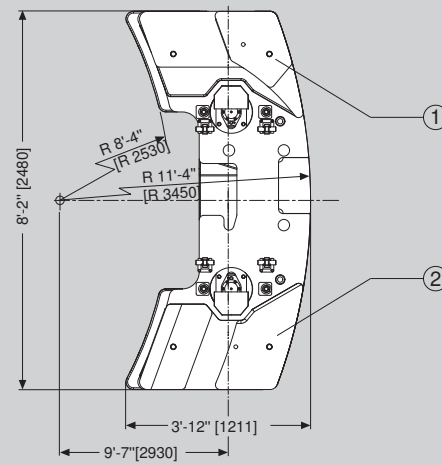
Equipment



Frame Torsion-resistant, welded construction made from high strength, fine grained steel. Central lubricating system.

Outriggers 4 point, telescopic hydraulic outriggers, incl. automatic length detection and controls on both sides of carrier and in superstructure cab. Outrigger base 21' (6.4 m) {14'-5" (4.4 m) mid extension} x 25'-11" (7.9 m).

Carrier engine Mercedes-Benz 6 cylinder model OM 470 LA (Euromot IV / EPA Tier 4f), water-cooled diesel engine. Rated at 435 HP (320 kW) at 1,700 rpm. Torque 1549 ft-lbs (2,100 Nm / 214 kpm) at 1,300 rpm. Engine rating according to ECE R 120. Fuel tank 106 gal (400 l). DEF Tank 11 gal (40 l).

Transmission ZF-AS-Tronic 2531 mechanical transmission with electro-pneumatically operated dry-type clutch and automatic gear shifting with 12 forward gears and 2 reverse gears.

Transfer Case Two stage.

Drive 8 x 6 (8 x 8 option)

Axles

1st axle: steered, not driven.

2nd axle: steered, driven, with differential lock, transverse,

3rd axle: steered, driven, with differential locks, longitudinal and transverse.

4th axle: steered, driven, with differential lock, transverse.

Suspension Hydro-pneumatic with levelling adjustment.

Brake system Service disc brakes: dual circuit compressed air system. Parking brake: spring loaded type acting on 2nd, 3rd and 4th axle. Auxiliary brakes: Intarder and engine brake.

Tires (8) 445/95 R 25 (16.00 R 25), width 8'-9" (2.66 m).
(8) 525/80 R 25 (20.50 R 25), width 9'-4" (2.85 m).

Steering system ZF-Servocom, dual circuit hydraulic steering with emergency steering pump, mechanical hydraulically assisted steering of front two axles and automatic steering of the 4th axle up to a travel speed of 15.5 mph (25 km/h). Steering of all axles possible. All axles steered hydrostatically from superstructure cab.

Carrier cab Two-man full width cab of composite (steel sheet metal and fibre-glass) structure, with safety glass, air-cushioned adjustable seats (driver seat with heater) and engine dependent water heater, radio/CD-player, complete controls and instrumentation for road travel. Cruise control with hill breaking feature functions.

Electrical system 24 volt DC system, 2 batteries, outrigger area lighting.
Electrical system conforms with European standard regulations.

Optional Equipment (at extra charge)

Towing attachment, engine independent additional heater with engine pre-heat, 8 x 8 drive, 525 / 80 R 25 (20.50 R 25) tires, spare wheel and tire, special painting and lettering.

Further optional equipment available upon request.

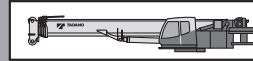

Frame Torsion-resistant, all-welded structure of high strength steel. Connected to carrier by single-row ball bearing slewing ring with external gearing for 360° continuous rotation. Central lubricating system.

Superstructure engine Mercedes-Benz 4 cylinder model OM 934 LA (Euromot IV / EPA Tier 4f), water-cooled, diesel engine. RPM infinitely variable via foot pedal, rating 175 HP (129 kW) at 2,200 rpm. Torque 553 ft-lbs (750 Nm / 77 kpm) at 1,200 - 1,600 rpm. Engine rating according to ECE R 120. Fuel tank 58 gal (220 l). DEF Tank 2.6 gal (10 l).

Hydraulic system Three circuit diesel hydraulic system with 1 power controlled axial piston double pump (hydraulically adjustable) and 1 double gear pump, oil cooler.

Controls Electrical, 2 joy-stick levers for simultaneous operation of crane motions.

Telescopic boom 5 sections, made of high tensile, fine-grained steel, consisting of 1 base section and 4 telescoping sections extended by means of a single telescopic cylinder. All telescope sections extendable under partial load. 36.1 ft (11.0 m) to 144.4 ft (44.0 m) long. Boom head with 6 sheaves.

Derricking system 1 double acting hydraulic cylinder with integral brake and holding valve.

Main winch Axial piston motor, winch drum with integrated planetary reduction and hydraulically controlled spring loaded, multiple disc brake and integrated free rotation (no sagging of load when hoisting).
Hoist cable with 'Super-Stop' easy reeving system.

Slewing system Axial piston motor with two-stage planetary reduction with a foot actuated service brake and a parking brake. Speed infinitely variable 0 - 2.0 rpm.

Counterweight Standard 24,251 lbs (11.0 t) divisible, assembled and disassembled by hydraulic cylinders controlled from superstructure cab.

Superstructure cab Spacious panoramic cab of composite structure with safety (tinted) glass windows, tiltable cockpit with hydraulically cushioned adjustable seat with heater, engine independent heater with engine pre-heat, air conditioning, radio/CD-player, complete controls and instrumentation for crane operation, on-site travelling and outriggers.

Electrical system 24 volt DC system, 2 batteries.

Safety devices Load moment device (LMD), incl. asymmetrical outrigger base, slewing area limitation, working area limiter, hoist limit switch, lower limit switch and drum turn indicator, anemometer, safety valves against pipe and hose rupture, holding valves on hydraulic cylinders.

Optional Equipment (at extra charge)

'Lift Adjuster', Boom extensions 29.5 ft (9.0 m) / 52.5 ft (16.0 m), offsets 0°, 20° and 40° or hydraulically 0°- 40°, heavy duty jib 5.2 ft (1.6 m). Additional counterweight 12,125 lbs (5.5 t), selection of hook blocks, auxiliary winch (same as main winch), additional oil cooler, special painting and lettering.

Further optional equipment available upon request.



Chasis portante Construcción de acero de alta resistencia soldado, resistente a la torsión y a la flexión. Sistema de engrase central.

Estabilizadores Estabilizadores hidráulicos de 4 puntos incl. detección de logitud automática a posibilidad de manejo desde ambos lados del chasis portante y desde la cabina de la grúa. Extensión de los estabilizadores: 6,4 m (y 4,4 m) x 7,9 m.

Motor Mercedes-Benz modelo OM 470 LA (Euromot IV / EPA Tier 4f), 6 cilindros, diesel, refrigerado por agua. Nominal 320 kW (435 CV) a 1700 min⁻¹. Par 2100 Nm (214 kpm) a 1300 min⁻¹. Potencia del motor según ECE R 120. Depósito de combustible de 400 l. Depósito AdBlue 40 l.

Transmisión Transmisión mecánica tipo ZF-AS Tronic modelo 12 AS 2531 con accionamiento electro - neumáticamente embrague en seco y cambio automático, 12 marchas delanteras y 2 marchas traseras.

Transmisión Caja de distribución (transfer) con 2 relaciones de velocidad.

Tracción 8 x 6 (8 x 8 opción)

Ejes

- 1º eje: de dirección, no accionado
- 2º eje: de dirección, accionado, con bloqueo diferencial transversal.
- 3º eje: de dirección, accionado, con bloqueo diferencial transversal y longitudinal.
- 4º eje: de dirección, accionado, con bloqueo diferencial transversal.

Suspensión Suspensión hidroneumática con regulación de nivel.

Sistemas de frenos Sistema de frenos de disco neumático de doble circuito con Sistema anti bloqueo ABS. Freno de estacionamiento del tipo freno de muelle, accionando sobre los ejes 2º, 3º y 4º. Intarder y freno motor como freno continuo.

Neumáticos (8) 445 / 95 R 25 (16.00 R 25), (ancho 2,66 m).
(8) 525 / 80 R 25 (20.50 R 25), (ancho 2,85 m).

Dirección Hidráulica ZF Servocom de doble circuito. Dirección mecánica al 1º y 2º eje y direccionable del 4º eje hasta una velocidad de 25 km/h. Bomba hidráulica de emergencia accionada por la transmisión. Dirección de todos los ejes. Desde la cabina de la superestructura: dirección hidro-stática a ambos ejes.

Cabina Cabina para dos personas, en construcción de acero y fibra de vidrio. Cristales de seguridad, asiento con suspensión neumática, asiento de conductor calefactado. Calefacción por agua caliente del motor, radio / CD-player. Elementos de control y manejo para circular por carretera. Regulador de velocidad, sistema automático de frenado.

Sistema eléctrico Sistema de 24 V c.c. con dos baterías, faros de trabajo en los estabilizadores. El sistema eléctrico cumple la normativa CE.

Equipo adicional (con suplemento de precio)
Embrague de remolque, calefacción adicional con precalefacción del motor, Tracción 8 x 8, neumáticos 525 / 80 R 25 (20.50 R 25), rueda de repuesto, pintura especial y rotulación.

Otros equipamientos sobre pedido.

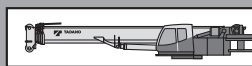

Superestructura Construida en aceros soldados, resistente a la torsión. Corona de giro con rodamiento de una fila de bolas con dientes externos para giro continuo a 360°. Sistema de engrase central.

Motor Mercedes-Benz modelo OM 934 LA (Euromot IV / EPA Tier 4f) 4 cilindros, diesel, refrigerado por agua. Las revoluciones aumentan de forma gradual accionado el acelerador. Nominal 129 kW (175 CV) a 2200 min⁻¹. Par 750 Nm (77 kpm) a 1200 - 1600 min⁻¹. Potencia del motor según ECE R 120. Depósito de combustible de 220 l. Depósito AdBlue 10 l.

Sistema hidráulico Sistema hidráulico de 3 circuitos, 1 bomba doble de pistones axiales de caudal variable (regulable hidráulicamente) y una bomba de engranajes, enfriador de aceite.

Mandos 2 palancas de control de tipo joy-stick para movimientos simultáneos de la grúa (4 direcciones), asistidas eléctricamente.

Pluma telescópica 5 secciones, un tramo base y 4 telescópicos de acero de alta resistencia soldado, 1 cilindro hidráulico, los tramos se pueden telescopar hidráulicamente bajo carga. Longitud de 11,0 m a 44,0 m. Cabeza de pluma con 6 poleas.

Elevación de pluma Mediante un cilindro hidráulico de doble efecto con válvula de retención integrada.

Cabrestante principal Motor hidráulico de pistones axiales y caudal fijo. Tambor del cabrestante con reducción planetaria y frenos de disco múltiples accionado, con sistema libre de elevación. Cable de elevación con sistema fácil de guiado y 'Super-Stop'.

Sistema de giro Motor hidráulico de pistones axiales con reducción planetaria de dos etapas. Freno de servicio controlado por pedal y freno de estacionamiento. Velocidad de giro variable de 0 a 2,0 min⁻¹.

Contrapeso El estándar 11,0 t divisible, se acciona desde la cabina de la grúa.

Cabina de la grúa Cabina espaciosa y confortable, en construcción de acero y fibra de vidrio, con cristales tintados de seguridad. Asiento de operador regulable amortiguado hidráulicamente, inclinable junto con los instrumentos y mandos, asiento calefactado. Calefacción independiente del motor y precalefacción del motor, climatización, radio / CD player. Elementos de control y mando para el manejo de la grúa y para el desplazamiento en obra. Mandos para nivelación y extensión de los estabilizadores.











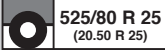
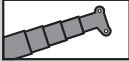
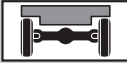
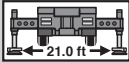
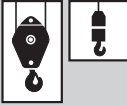
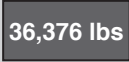



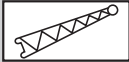

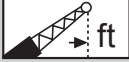

Sistema eléctrico Sistema de 24 V c.c. con dos baterías.

Medidas de seguridad Limitación del momento de carga (LMC), incl. base de apoyo asimétrica, limitador de giro, limitación del área de trabajo, interruptor de final de elevación, interruptor de 3 últimas vueltas en cabrestante, indicador de bajada o subida del cable del cabrestante, anemómetro, válvulas de seguridad para rotura de tubos y latiguillos. Válvulas de retención en los cilindros hidráulicos.

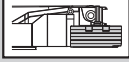
Equipo adicional (con suplemento de precio)
'Lift Adjuster', plumín de 9,0 m / 16,0 m regulable de 0°, 20° y 40° (o hidráulicamente 0° a 40°), plumín de carga pesada de 1,6 m, contrapeso adicional de 5,5 t, selección de ganchos, 2º cabrestante, enfriador adicional, pintura especial e rotulación.

Otros equipamientos sobre pedido.

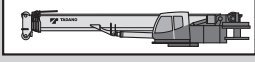
Symbols / Glosario de simbolos

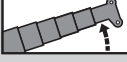
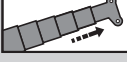
 525/80 R 25 (20.50 R 25)	Tires / Size Neumáticos / Tamaño de ruedas		Telescopic boom Pluma telescópica
	Axle load Carga por eje	 21.0 ft	Outriggers Estabilizadores
	Hook block / Swivel hook Gancho / Gancho de bola	 36,376 lbs	Counterweight Contrapeso
 V+	Carrier speeds Velocidades del chasis		Radius Radio
	Transmission / Gear Transmisión / Marchas		Boom extension Plumin
	Gradeability Superacion de pendientes	 HYDRO	Boom extension hydraulically Plumin hidráulicamente
	Off road Todo terreno		Radius Radio
	On road En carretera		Nach hinten Over rear
 V+	Superstructure speeds Velocidades de la superestructura		Counterweight versions Variaciones de contrapeso
	Main winch Cabrestante principal		Carrier chasis
	Auxiliary winch 2° cabrestante		Superstructure superestructura
 360° LOCK	Slewing system / hydraulically locked Sistema de giro / Embulonamiento hidráulico	 SAE	The data are for basic information only and the operator's manual must be consulted before operating this crane. All data and performances refer to the standard crane. The addition of optional and other equip- ment may affect the performance of the crane.
	Derricking system Elevación de pluma		
	Boom telescoping Telescopaje de pluma		Los datos sirven solamente para su información. Hay que leer las instruc- ciones para el uso antes de la puesta en servicio de la máquina. Todos los datos mencionados en las presen- tes tablas rigen para los modelos standard. Cualquier modificación del equipo montado puede dar lugar a modificaciones de aquellos valores.

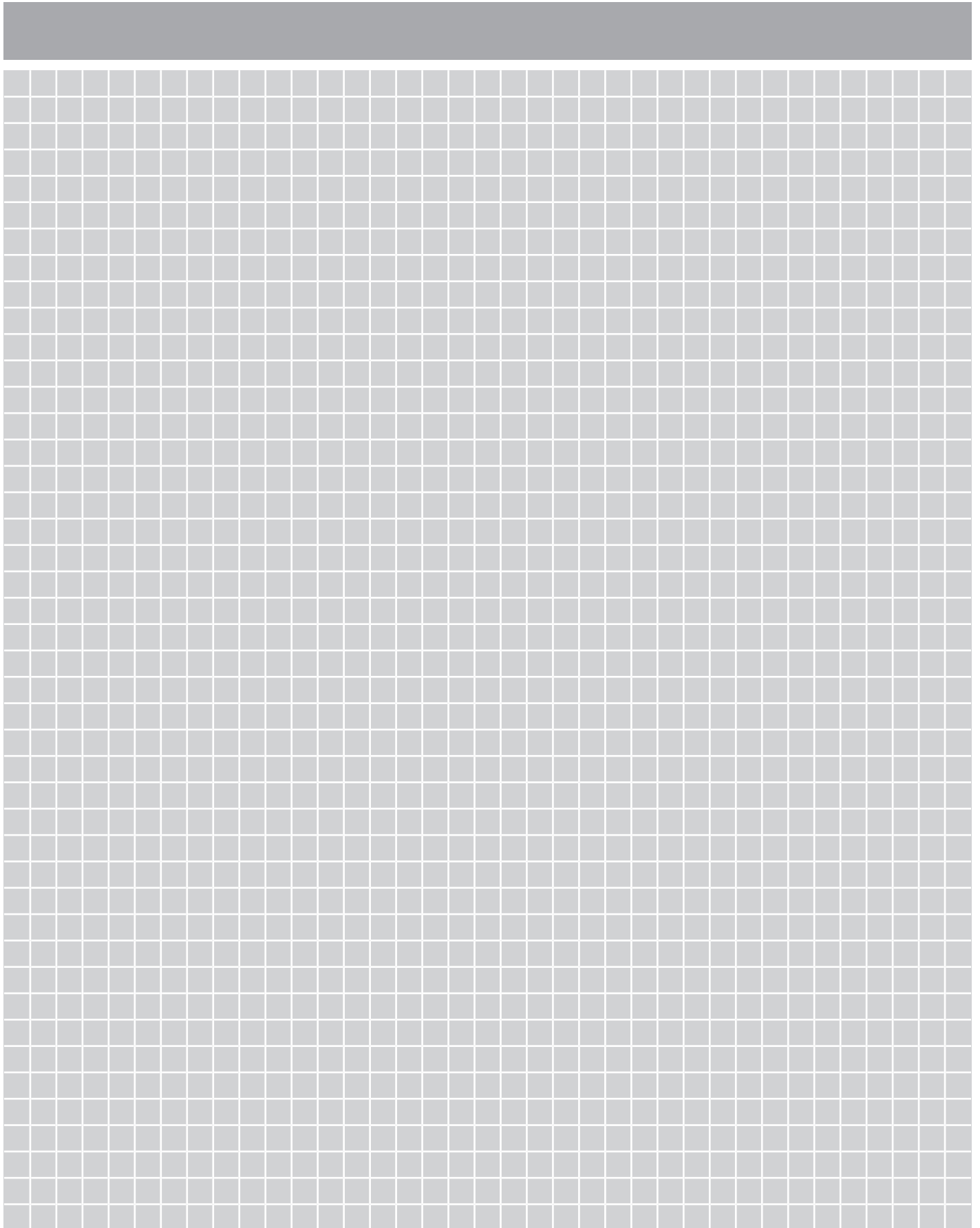

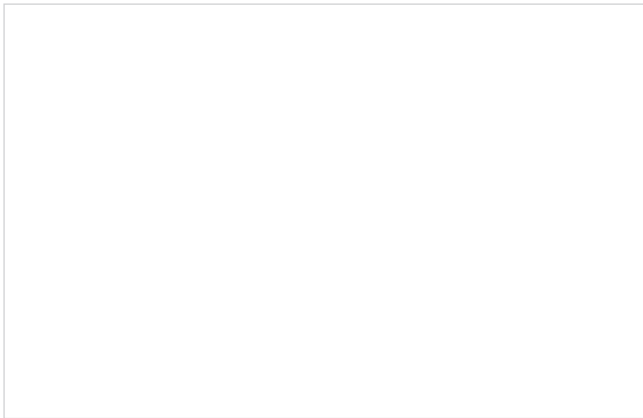

TADANO AMERICA Corporation
4242 West Greens Road, Houston, TX 77066
Phone: 281-869-0030 Fax: 281-869-0040
www.tadanoamerica.com E-mail: tac.sales@tadano.com
Parts Hotline: 281-869-0033 Service Hotline: 281-869-5925