



ALL TERRAIN CRANE



ATF 220G-5

250 TON CAPACITY

ALL TERRAIN CRANE



2 ENGINES

Dimensions (ft, mm) / Dimensiones (ft, mm)

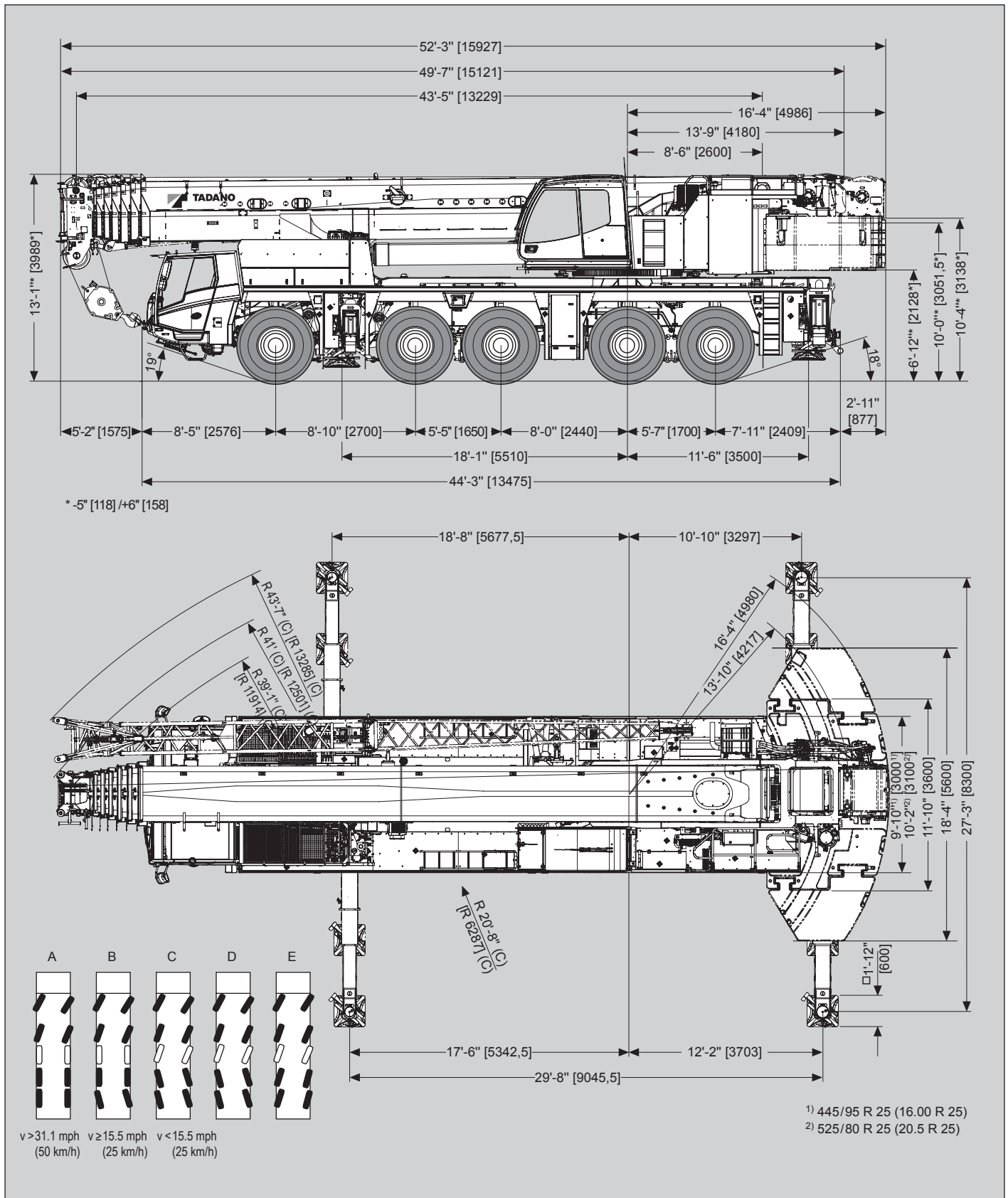

445/95 R 25 (16.00 R 25)	525/80 R 25 (20.50 R 25)
-----------------------------	-----------------------------

SAE







Weights / Working speeds / Pesos / Velocidades de trabajo









 * Rams horn * Gancho doble	 Lifting capacity Capacidad de elevación [lbs]		Sheaves Poleas	Part of line Ramales de cable	Weight Peso [lbs]
	344,400 (Type / Typo 220.5 ton)*	9	19	3,527	
	275,000 (Type / Typo 176.4 ton)*	7	15	2,866	
	204,200 (Type / Typo 137.8 ton)*	5	11	2,535	
	112,900 (Type / Typo 88.1 ton)*	3	6	1,874	
	112,900 (Type / Typo 88.1 ton)	3	6	1,874	
	56,900 (Type / Typo 35.3 ton)	1	3	992	
	19,200 (Type / Typo 11.0 ton)	-	1	661	



 445/95 (16.00) 525/80 (20.50) mph	 	1	2	3	4	5	6	7	8	9	10	11	12	R1	R2	 63%* 48%
		3.7	5.0	6.2	8.1	9.9	13.0	16.8	21.7	28.0	36.0	46.0	52.8	3.7	5.0	

* Off road range / * Con transmisión todo terreno

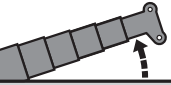
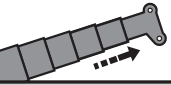
V+ 	Infinitely variable Infinitamente variable	Rope (diameter/length) Cable (diámetro/longitud)	Max. single line pull Trio máximo por ramal
	0 - 420 ft/min 0 - 128 m/min single line ramal simple	0.83'/ 1,049.9' 21 mm / 320 m	22,031 lbs 98 kN
	0 - 420 ft/min 0 - 128 m/min single line ramal simple	0.83'/ 1,049.9' 21 mm / 320 m	22,031 lbs 98 kN
	Max. permissible line pull may be affected by wire rope strength, which should not exceed 19,200 lbs for main winch and auxiliary winch La fuerza max del cabestrante es dependiente de la normativa en vigor, la cual no permite superar los 85,4 kN de fuerza.		
	0 - 1.2 rpm		0° + 180°
	-1.5° - +84° approx. 50 s aproximadamente 50 s		
	43.4 ft - 223.1 ft 13.2 m - 68.0 m approx. 500 s aproximadamente 500 s		

Lifting heights / Alturas de elevación

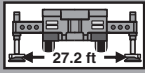
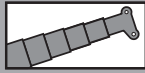



156,527 lbs

lbs x 1,000

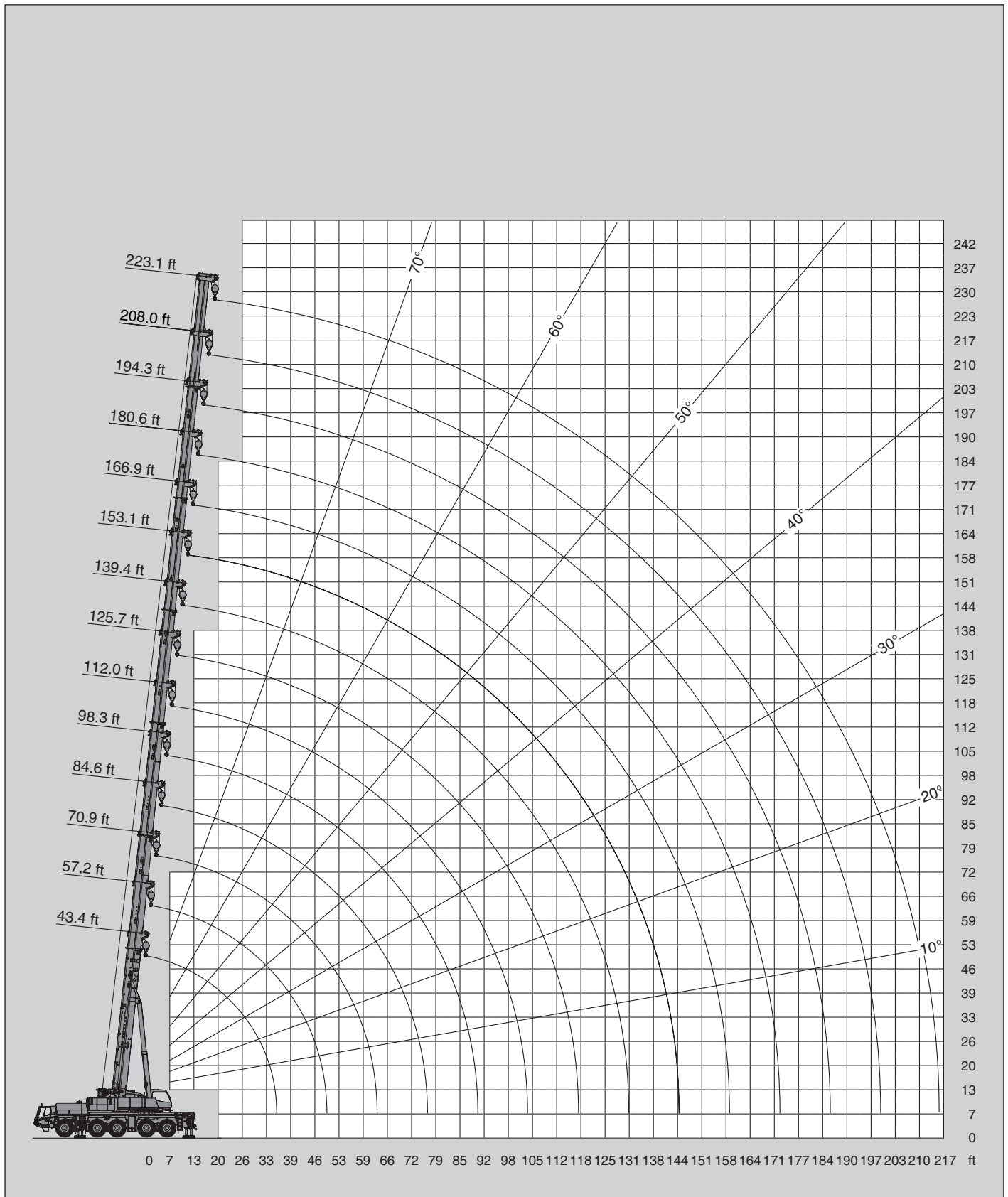
SAE

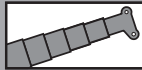
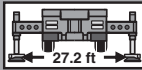

156,527 lbs



lbs x 1,000 SAE

 ft	43.4 ft*	43.4 ft	57.2 ft	70.9 ft	84.6 ft	98.3 ft	112.0 ft	125.7 ft	139.4 ft	153.1 ft	166.9 ft	180.6 ft	194.3 ft	208.0 ft	223.1 ft
8.2	485.0**														
9.8	396.8**	389.1**	308.6**	308.6**	252.2										
11.5	373.7**	352.7**	308.6**	308.6**	252.0	199.5									
13.1	352.7**	331.8**	308.6**	308.6**	239.9	199.5									
14.8	331.8**	304.2**	303.6**	301.8**	228.6	199.5	154.3								
16.4	298.7**	280.0**	279.5**	277.8**	227.1	191.8	154.3	120.2							
19.7	248.0	240.3	240.3	238.5	227.1	175.9	154.3	120.2	95.9						
23.0	212.3	210.5	209.7	207.7	209.2	170.9	145.9	120.2	95.9	76.1					
26.2	184.3	184.3	183.9	181.9	183.2	170.9	134.9	120.2	95.9	76.1	62.8				
29.5	162.0	162.0	161.4	159.6	160.9	162.5	127.9	114.6	95.7	76.1	62.8	50.7			
32.8	144.2	144.2	143.3	141.5	142.6	144.4	127.9	107.8	91.3	76.1	62.8	50.7	41.4		
36.1			128.5	126.8	127.9	129.4	125.0	100.8	86.9	75.2	62.8	50.7	41.4	33.1	
39.4			116.2	114.4	115.5	117.1	119.0	94.4	82.9	71.9	62.4	50.7	41.4	33.1	30.4
45.9			97.0	95.2	96.3	97.7	99.6	88.2	78.5	66.1	59.1	50.3	41.4	33.1	30.4
52.5				80.7	81.8	83.1	85.1	82.2	71.4	62.8	54.9	48.1	41.4	33.1	30.4
59.1				69.7	70.5	71.9	73.6	75.2	64.6	58.2	50.9	45.0	40.3	33.1	29.5
65.6					61.5	62.8	67.0	66.1	59.1	54.0	47.4	42.1	37.9	33.1	28.9
72.2					54.0	57.8	60.0	58.6	54.2	50.5	44.3	39.2	35.7	32.6	28.2
78.7						54.2	53.8	52.2	50.0	46.7	41.4	36.8	33.5	30.9	27.6
85.3						49.6	48.5	47.2	45.9	43.7	38.8	34.6	31.7	29.3	26.9
91.9							44.1	42.5	41.2	40.6	36.6	32.6	30.0	27.8	25.1
98.4							40.1	38.4	36.8	36.4	34.4	30.9	28.2	26.2	23.4
105								34.6	34.2	32.6	32.4	29.1	26.7	24.9	21.8
112								31.5	32.6	29.3	29.8	27.6	25.4	23.8	20.5
118									30.0	26.2	26.7	26.2	24.0	22.5	19.2
125									27.3	24.3	25.6	23.6	22.9	21.6	18.1
131										23.4	24.3	22.0	20.7	20.5	17.0
138										22.7	22.0	20.1	19.6	18.7	16.1
144										17.9	20.3	18.1	18.3	17.6	15.0
151											18.5	17.0	17.4	16.8	14.1
158											15.7	16.1	15.7	15.9	13.4
164												15.2	14.8	15.0	12.6
171												14.3	13.9	13.9	11.9
177													13.2	12.8	11.2
184													12.6	11.7	10.6
190														10.6	10.1
197														9.7	9.5
203															8.6
210															7.7

* Over rear / * Sobre la parte trasera

** With additional lifting equipment / ** Con equipo adicional

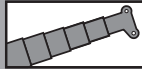
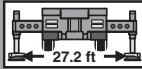
Lifting capacities / Capacidades de elevación



103,616 lbs

lbs x 1,000 SAE

 ft	43.4 ft*	43.4 ft	57.2 ft	70.9 ft	84.6 ft	98.3 ft	112.0 ft	125.7 ft	139.4 ft	153.1 ft	166.9 ft	180.6 ft	194.3 ft	208.0 ft	223.1 ft
8.2	485.0**														
9.8	396.8**	384.7**	308.6**	308.6**	252.2										
11.5	373.7**	347.0**	308.6**	308.6**	252.0	199.5									
13.1	339.7**	315.0**	308.6**	308.6**	239.9	199.5									
14.8	302.5**	287.9**	286.8**	284.8**	228.6	199.5	154.3								
16.4	272.0**	264.3**	263.2**	261.2**	227.1	191.8	154.3	120.2							
19.7	226.0	226.0	224.9	222.9	224.4	175.9	154.3	120.2	95.9						
23.0	191.4	191.4	190.5	188.5	189.8	170.9	145.9	120.2	95.9	76.1					
26.2	165.1	165.1	164.0	162.3	163.6	165.3	134.9	120.2	95.9	76.1	62.8				
29.5	144.8	144.8	143.7	142.0	143.3	144.8	127.9	114.6	95.7	76.1	62.8	50.7			
32.8	128.5	128.5	127.4	125.7	126.8	128.5	127.9	107.8	91.3	76.1	62.8	50.7	41.4		
36.1			114.0	112.2	113.5	115.1	117.1	100.8	86.9	75.2	62.8	50.7	41.4	33.1	
39.4			102.7	100.8	102.1	103.6	105.6	94.4	82.9	71.9	62.4	50.7	41.4	33.1	30.4
45.9			84.9	82.5	84.0	85.8	87.5	88.2	78.5	66.1	59.1	50.3	41.4	33.1	30.4
52.5				65.9	67.2	73.0	75.4	73.6	71.4	62.8	54.9	48.1	41.4	33.1	30.4
59.1				57.8	60.8	64.2	63.1	61.3	59.5	58.2	50.9	45.0	40.3	33.1	29.5
65.6					55.1	54.7	53.6	51.8	50.3	49.8	47.4	42.1	37.9	33.1	28.9
72.2					47.8	47.4	46.3	44.5	44.1	42.5	43.0	39.2	35.7	32.6	28.2
78.7						41.4	40.3	38.6	40.1	36.6	37.0	36.8	33.5	30.9	27.6
85.3						36.6	35.5	33.7	35.3	32.2	33.1	32.8	31.7	29.3	26.9
91.9							31.5	29.8	31.3	30.4	30.6	29.3	29.8	27.8	25.1
98.4							28.2	26.5	27.8	28.7	27.1	27.6	26.2	26.2	23.4
105								23.4	24.9	25.8	24.0	24.5	24.5	24.3	21.8
112								20.7	22.0	23.1	21.6	22.5	22.7	21.4	20.5
118									20.1	20.7	20.3	20.9	20.3	19.0	19.0
125									19.2	18.7	19.0	19.2	18.3	17.0	16.8
131										17.6	17.9	17.4	16.3	15.0	15.0
138										16.8	16.8	15.7	14.6	13.2	13.2
144										15.9	15.2	14.1	13.0	11.7	11.7
151											13.9	12.8	11.7	10.4	10.4
158											12.6	11.5	10.4	9.3	9.0
164												10.4	9.3	7.9	7.9
171												9.5	8.4	7.1	6.8
177													7.3	6.0	6.0
184													6.6	5.1	5.1
190														4.4	4.2
197														3.7	3.5
203															2.9

* Over rear / * Sobre la parte trasera

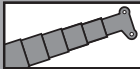
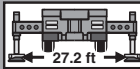
** With additional lifting equipment / ** Con equipo adicional

77,161 lbs



lbs x 1,000 SAE

 ft	43.4 ft*	43.4 ft	57.2 ft	70.9 ft	84.6 ft	98.3 ft	112.0 ft	125.7 ft	139.4 ft	153.1 ft	166.9 ft	180.6 ft	194.3 ft	208.0 ft	223.1 ft
8.2	485.0**														
9.8	396.8**	374.6**	308.6**	308.6**	252.2										
11.5	367.9**	337.1**	308.6**	308.6**	252.0	199.5									
13.1	323.0**	305.3**	304.5**	302.5**	239.9	199.5									
14.8	287.3**	278.4**	277.3**	275.4**	228.6	199.5	154.3								
16.4	258.4	255.1	254.2	252.2	227.1	191.8	154.3	120.2							
19.7	213.2	213.2	212.3	210.3	211.6	175.9	154.3	120.2	95.9						
23.0	180.1	180.1	179.0	177.2	178.6	170.9	145.9	120.2	95.9	76.1					
26.2	155.2	155.2	154.3	152.3	153.7	155.4	134.9	120.2	95.9	76.1	62.8				
29.5	136.0	136.0	134.9	133.2	134.5	136.0	127.9	114.6	95.7	76.1	62.8	50.7			
32.8	120.2	120.2	119.0	117.1	118.4	119.9	119.9	107.8	91.3	76.1	62.8	50.7	41.4		
36.1			105.4	102.7	104.5	106.9	106.0	99.6	86.9	75.2	62.8	50.7	41.4	33.1	
39.4			90.6	88.2	89.9	92.2	94.6	94.1	82.9	71.9	62.4	50.7	41.4	33.1	30.4
45.9			69.9	68.8	73.6	78.7	77.6	75.6	72.8	66.1	59.1	50.3	41.4	33.1	30.4
52.5				62.4	64.4	63.9	62.8	61.1	59.3	58.6	54.9	48.1	41.4	33.1	30.4
59.1				53.1	53.6	53.1	52.0	50.3	50.5	48.3	48.7	45.0	40.3	33.1	29.5
65.6					45.6	45.2	44.1	42.3	43.9	40.3	40.8	41.2	37.9	33.1	28.9
72.2					39.5	38.8	37.7	35.9	37.5	36.2	37.0	35.7	35.7	32.6	28.2
78.7						33.7	32.6	30.9	32.4	33.5	32.0	32.2	31.1	30.9	27.6
85.3						29.8	28.4	26.7	28.2	29.3	27.8	28.4	29.1	27.8	26.9
91.9							25.1	23.1	25.1	26.5	26.0	26.5	25.4	24.3	24.0
98.4							23.6	21.8	23.6	24.5	24.3	23.4	22.3	20.9	20.9
105								20.5	22.3	22.3	21.8	20.7	19.6	18.3	18.3
112								19.4	20.7	19.8	19.4	18.3	17.2	15.9	15.9
118									18.5	17.9	17.2	16.3	15.2	13.9	13.7
125									16.8	16.1	15.4	14.3	13.2	12.1	11.9
131										14.3	13.9	12.8	11.7	10.4	10.4
138										13.0	12.3	11.2	10.1	9.0	8.8
144										11.9	11.0	9.9	9.0	7.5	7.5
151											9.9	8.8	7.7	6.4	6.4
158											8.8	7.7	6.6	5.3	5.3
164												6.8	5.7	4.4	4.2
171												6.0	4.9	3.5	3.3
177													4.0	2.6	2.4
184													3.3		

* Over rear / * Sobre la parte trasera

** With additional lifting equipment / ** Con equipo adicional

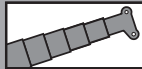
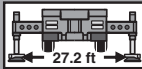
Lifting capacities / Capacidades de elevación



51,808 lbs

lbs x 1,000 SAE

 ft	43.4 ft*	43.4 ft	57.2 ft	70.9 ft	84.6 ft	98.3 ft	112.0 ft	125.7 ft	139.4 ft	153.1 ft	166.9 ft	180.6 ft	194.3 ft	208.0 ft	223.1 ft
8.2	478.8**														
9.8	396.8**	364.2**	308.6**	308.6**	252.2										
11.5	349.2**	326.7**	308.6**	308.6**	252.0	199.5									
13.1	306.4**	295.2**	294.3**	292.3**	239.9	199.5									
14.8	272.5**	268.5**	267.4**	265.4**	228.6	199.5	154.3								
16.4	244.3	244.3	243.2	241.2	227.1	191.8	154.3	120.2							
19.7	200.4	200.4	199.5	197.5	198.9	175.9	154.3	120.2	95.9						
23.0	169.1	169.1	168.2	166.2	166.7	159.6	145.9	120.2	95.9	76.1					
26.2	145.3	145.3	144.2	142.2	137.3	132.9	127.9	120.2	95.9	76.1	62.8				
29.5	125.0	125.0	123.2	120.2	116.0	112.9	110.9	103.4	95.7	76.1	62.8	50.7			
32.8	103.0	103.0	101.2	98.3	99.4	97.7	99.2	95.5	86.0	76.1	62.8	50.7	41.4		
36.1			84.9	82.2	87.5	91.7	90.4	84.4	79.1	75.2	62.8	50.7	41.4	33.1	
39.4			72.8	76.7	82.5	82.5	80.7	75.4	70.5	67.5	62.4	50.7	41.4	33.1	30.4
45.9			61.5	63.9	64.6	64.2	62.8	61.1	59.1	54.9	53.6	50.3	41.4	33.1	30.4
52.5				51.4	52.0	51.6	50.5	48.7	50.5	45.2	44.3	43.9	41.4	33.1	30.4
59.1				42.5	43.0	42.5	41.4	39.7	41.4	41.0	40.6	39.9	37.3	33.1	29.5
65.6					36.4	35.7	34.6	33.1	34.6	35.7	34.4	34.8	33.1	32.0	28.9
72.2					32.2	30.4	30.0	28.9	31.1	32.4	32.0	31.1	29.8	27.6	26.7
78.7						26.0	28.0	26.7	28.7	28.0	27.6	26.7	25.6	23.8	23.1
85.3						23.6	25.4	24.9	25.1	24.3	23.8	22.9	21.8	20.3	19.8
91.9							22.5	22.0	22.0	21.4	20.7	19.6	18.5	17.2	17.0
98.4							19.8	19.4	19.4	18.5	18.1	17.0	15.9	14.3	14.3
105								17.2	17.0	16.3	15.7	14.6	13.4	12.1	12.1
112								15.2	15.0	14.1	13.7	12.6	11.5	10.1	10.1
118									13.2	12.3	11.9	10.8	9.7	8.4	8.4
125									11.7	10.8	10.4	9.3	8.2	6.8	6.8
131										9.5	9.0	7.9	6.8	5.5	5.3
138										8.4	7.7	6.6	5.5	4.2	4.2
144										7.5	6.6	5.5	4.4		
151											5.7	4.6	3.5		
158											4.9	3.7	2.6		
164												2.9			

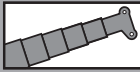
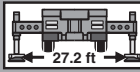

* Over rear / * Sobre la parte trasera

** With additional lifting equipment / ** Con equipo adicional

   26,455 lbs lbs x 1,000 SAE															
ft	43.4 ft*	43.4 ft	57.2 ft	70.9 ft	84.6 ft	98.3 ft	112.0 ft	125.7 ft	139.4 ft	153.1 ft	166.9 ft	180.6 ft	194.3 ft	208.0 ft	223.1 ft
8.2	455.9**														
9.8	383.8**	352.7**	308.6**	308.6**	252.2										
11.5	330.7**	315.7**	308.6**	308.6**	252.0	199.5									
13.1	290.1**	284.4**	283.3**	281.3**	239.9	199.5									
14.8	256.6	256.6	255.5	253.5	228.6	199.5	154.3								
16.4	229.1	229.1	228.0	226.0	221.3	191.8	154.3	120.2							
19.7	187.8	187.8	186.7	178.6	167.1	158.3	144.4	120.2	95.9						
23.0	157.4	157.4	155.0	139.6	132.5	127.2	123.5	113.5	95.9	76.1					
26.2	122.8	122.8	120.8	113.1	108.5	105.6	108.7	95.9	90.2	76.1	62.8				
29.5	97.0	97.0	95.2	92.2	96.6	99.9	93.7	86.9	80.5	76.1	62.8	50.7			
32.8	79.4	79.4	78.0	86.2	89.1	86.6	81.6	75.6	70.1	66.6	62.8	50.7	41.4		
36.1			71.6	74.5	75.4	75.0	71.6	66.4	65.5	58.2	56.4	50.7	41.4	33.1	
39.4			61.5	64.2	65.0	64.4	63.3	58.4	58.6	51.1	49.8	48.7	41.4	33.1	30.4
45.9			46.3	49.2	49.8	49.2	48.1	46.1	47.0	46.7	43.0	41.9	38.8	33.1	30.4
52.5				38.4	41.0	38.6	38.6	38.1	40.3	41.2	39.5	37.0	33.1	32.0	30.4
59.1				31.3	33.3	32.2	34.6	34.2	34.2	33.5	33.1	31.1	28.9	26.5	25.6
65.6					27.6	28.0	28.7	28.4	28.4	27.6	27.1	26.2	24.3	22.0	21.4
72.2					23.1	23.6	24.3	24.0	23.8	23.1	22.7	21.6	20.5	18.3	17.9
78.7						20.1	20.7	20.3	20.3	19.4	19.0	17.9	16.8	15.2	14.8
85.3						17.2	17.6	17.2	17.2	16.3	15.9	14.8	13.7	12.1	12.1
91.9							15.0	14.8	14.6	13.9	13.2	12.1	11.0	9.7	9.7
98.4							13.0	12.6	12.3	11.7	11.2	10.1	9.0	7.5	7.5
105								10.8	10.6	9.9	9.3	8.2	7.1		
112								9.3	9.0	8.2	7.7	6.6	5.5		
118									7.7	6.8	6.4	5.3			
125									6.4	5.7	5.1	4.0			
131										4.6	4.0	2.9			
138										3.7	3.1				
144										2.9					

* Over rear / * Sobre la parte trasera

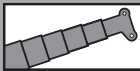
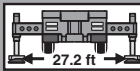
** With additional lifting equipment / ** Con equipo adicional

   0 lbs lbs x 1,000 SAE															
ft	43.4 ft*	43.4 ft	57.2 ft	70.9 ft	84.6 ft	98.3 ft	112.0 ft	125.7 ft	139.4 ft	153.1 ft	166.9 ft	180.6 ft	194.3 ft	208.0 ft	223.1 ft
8.2	430.6**														
9.8	362.4**	340.4**	308.6**	308.6**	252.2										
11.5	312.2**	303.4**	302.3**	300.3**	252.0	199.5									
13.1	271.8**	271.8**	270.7**	265.4**	227.1	199.5									
14.8	239.4	239.4	238.5	212.3	191.6	170.9	154.3								
16.4	213.6	213.6	203.0	175.5	160.9	150.1	133.8	120.2							
19.7	165.1	165.1	145.3	127.9	119.9	117.9	112.4	99.4	92.4						
23.0	124.8	124.8	110.9	102.7	107.8	103.0	95.2	85.8	77.6	72.1					
26.2	93.7	93.7	88.0	95.7	90.8	84.4	77.6	70.3	69.2	59.3	56.7				
29.5	73.2	73.2	79.8	78.7	75.2	70.3	64.8	58.6	58.2	55.8	49.8	46.3			
32.8	57.8	57.8	64.4	65.9	63.5	59.7	55.1	54.5	54.0	49.2	44.5	42.3	39.2		
36.1			52.7	55.8	54.5	51.4	50.7	51.1	49.2	46.3	41.7	37.3	34.0	33.1	
39.4			43.9	47.0	49.8	44.8	47.4	45.2	43.4	40.8	38.6	35.7	32.8	29.8	28.4
45.9			31.7	35.1	37.3	37.9	37.5	35.9	34.4	32.4	30.4	28.0	25.6	22.9	22.0
52.5				26.7	28.9	29.5	30.2	29.1	28.0	26.2	24.5	22.5	20.3	17.9	17.0
59.1				20.7	22.9	23.6	24.3	23.8	22.9	21.4	20.1	18.1	16.1	13.9	13.2
65.6					18.3	19.0	19.6	19.4	19.2	17.6	16.3	14.6	12.8	10.6	10.1
72.2					14.8	15.2	15.9	15.7	15.7	14.6	13.2	11.7	9.9	7.9	
78.7						12.3	13.0	12.8	12.6	11.9	10.8	9.3	7.7		
85.3						10.1	10.6	10.4	10.1	9.5	8.8	7.3			
91.9							8.8	8.4	8.2	7.5	7.1	5.5			
98.4							7.1	6.8	6.6	5.7	5.3				
105								5.3	5.1	4.4	3.7				
112								4.2	4.0	3.1					
118									2.9						

* Over rear / * Sobre la parte trasera

** With additional lifting equipment / ** Con equipo adicional

Lifting heights / Alturas de elevación

					156,527 lbs	lbs x 1,000	SAE
--	--	--	--	--	--------------------	-------------	------------

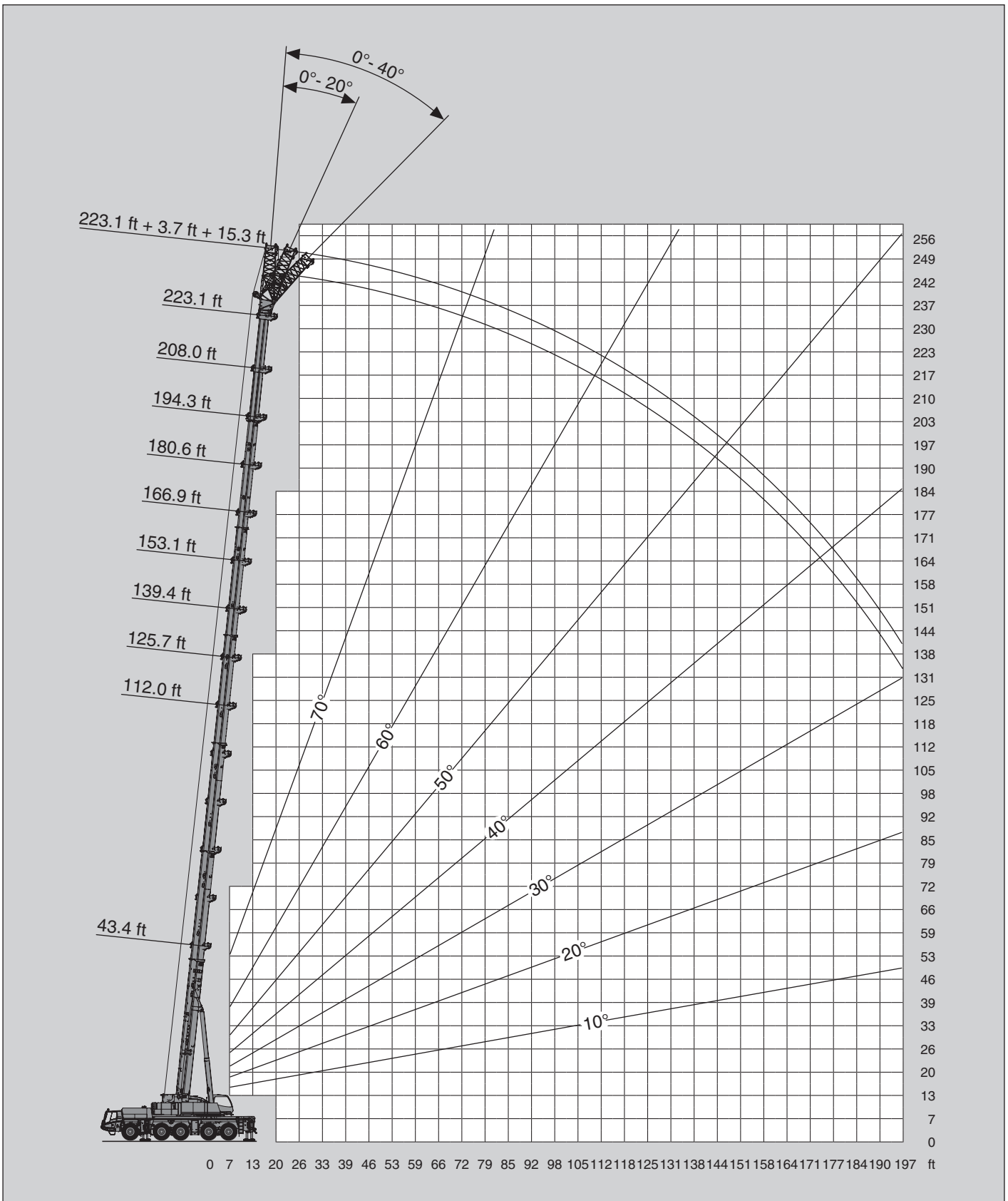

Lifting capacities / Capacidades de elevación











103,616 lbs

lbs x 1,000

SAE

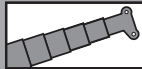
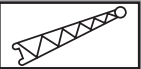
ft	43.4 ft + 3.7 ft + 15.3 ft			112.0 ft + 3.7 ft + 15.3 ft			125.7 ft + 3.7 ft + 15.3 ft			139.4 ft + 3.7 ft + 15.3 ft			153.1 ft + 3.7 ft + 15.3 ft		
	0°	20°	40°	0°	20°	40°	0°	20°	40°	0°	20°	40°	0°	20°	40°
9.8	105.4														
11.5	99.6	67.2													
13.1	94.4	65.0													
14.8	89.9	63.1	50.0												
16.4	85.8	61.1	48.9												
19.7	78.5	57.8	47.4	85.3											
23.0	72.5	54.9	45.9	85.3			66.8								
26.2	67.5	52.5	44.5	85.3	63.3		66.8			52.9			43.7		
29.5	63.1	50.3	43.4	85.3	61.5	47.6	66.8	63.7		52.9	52.9		43.7		
32.8	59.3	48.3	42.5	84.9	59.7	47.0	66.8	61.9	47.8	52.9	52.9		43.7	37.5	
36.1	56.2	46.7	41.4	80.2	58.2	46.3	66.8	60.4	47.2	52.9	52.9	47.8	42.3	36.2	32.6
39.4	53.1	44.5	40.6	76.1	56.9	45.6	66.8	59.1	46.5	52.9	52.9	47.2	40.6	35.1	31.7
45.9	45.9	41.0		68.8	54.2	44.3	63.7	56.4	45.4	52.9	52.0	46.1	37.7	32.8	30.0
52.5	40.1			62.4	51.8	43.4	58.0	54.0	44.3	50.0	48.3	45.0	35.1	31.1	28.4
59.1				56.4	50.0	42.5	53.1	51.8	43.4	46.5	45.0	44.1	33.1	29.3	27.1
65.6				47.2	48.3	41.9	49.2	48.1	42.8	43.4	42.1	41.4	31.3	28.0	26.0
72.2				39.9	41.2	41.0	42.3	43.7	42.1	40.8	39.7	38.8	29.8	26.9	25.1
78.7				34.0	35.3	35.7	36.4	37.5	38.1	36.2	37.0	36.6	28.4	25.8	24.3
85.3				28.9	30.0	30.6	31.5	32.6	33.1	31.3	32.2	32.8	27.1	24.9	23.6
91.9				24.7	25.6	26.0	27.3	28.2	28.9	26.9	27.8	28.4	26.0	24.0	22.9
98.4				21.2	21.8	22.0	23.6	24.5	24.9	23.4	24.0	24.5	24.5	23.1	22.3
105				18.1	18.5		20.5	21.4	21.6	20.1	20.9	21.2	21.4	22.3	21.8
112				15.4	15.9		17.9	18.5		17.4	18.1	18.3	18.7	19.6	19.8
118				13.0			15.7	16.1		15.0	15.7	15.9	16.3	17.0	17.4
125							13.4	13.9		13.0	13.4		14.3	14.8	15.0
131							11.7			11.2	11.5		12.3	13.0	
138										9.5	9.7		10.8	11.2	
144										8.2	8.2		9.3	9.7	
151													7.9	8.2	
158													6.8		

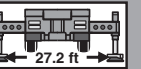
ft	166.9 ft + 3.7 ft + 15.3 ft			180.6 ft + 3.7 ft + 15.3 ft			194.3 ft + 3.7 ft + 15.3 ft			208.0 ft + 3.7 ft + 15.3 ft			223.1 ft + 3.7 ft + 15.3 ft		
	0°	20°	40°	0°	20°	40°	0°	20°	40°	0°	20°	40°	0°	20°	40°
32.8	39.2														
36.1	39.2	34.8		34.2											
39.4	37.9	33.7		34.2	30.9		28.4								
45.9	35.5	31.7	29.1	32.4	29.3	27.1	28.4	26.5		24.0	22.3		22.0		
52.5	33.5	30.0	27.8	30.6	27.8	25.8	27.1	25.1	23.8	22.7	21.2	20.3	20.7	19.4	
59.1	31.7	28.4	26.5	29.1	26.5	24.7	25.6	24.0	22.9	21.6	20.3	19.4	19.8	18.5	17.9
65.6	30.0	27.1	25.4	27.8	25.4	23.6	24.5	22.9	22.0	20.5	19.2	18.5	19.0	17.6	17.2
72.2	28.4	25.8	24.3	26.7	24.3	22.7	23.1	22.0	21.2	19.6	18.5	17.9	18.1	17.0	16.3
78.7	27.3	24.9	23.4	25.4	23.1	22.0	22.3	21.2	20.3	18.7	17.6	17.0	17.2	16.3	15.7
85.3	26.0	23.8	22.7	24.3	22.3	21.2	21.4	20.3	19.6	18.1	17.0	16.5	16.5	15.7	15.2
91.9	25.1	23.1	21.8	23.4	21.6	20.5	20.5	19.4	19.0	17.2	16.5	15.9	15.9	15.2	14.8
98.4	24.3	22.3	21.4	22.5	20.9	19.8	19.6	18.7	18.3	16.5	15.9	15.4	15.2	14.8	14.3
105	21.6	21.6	20.7	21.4	20.3	19.4	19.0	18.1	17.9	15.9	15.4	15.0	14.6	14.1	13.9
112	19.0	19.6	20.1	19.4	19.6	19.0	18.3	17.6	17.2	15.4	14.8	14.6	14.1	13.7	13.4
118	16.5	17.2	17.4	17.0	17.6	17.9	17.4	17.0	16.8	15.0	14.3	14.1	13.7	13.2	13.0
125	14.3	15.0	15.2	14.8	15.4	15.7	15.4	16.1	16.3	14.3	13.9	13.7	13.2	12.8	12.6
131	12.6	13.0	13.2	13.0	13.4	13.7	13.4	14.1	14.3	13.9	13.4	13.4	12.8	12.3	12.1
138	10.8	11.2		11.2	11.7	11.9	11.9	12.3	12.6	12.6	13.2	13.0	12.3	12.1	11.9
144	9.3	9.7		9.7	10.1	10.4	10.4	10.8	11.0	11.2	11.7	12.1	11.5	11.7	11.7
151	7.9	8.2		8.4	8.6		9.0	9.3	9.5	9.7	10.1	10.8	9.9	10.4	10.6
158	6.8	7.1		7.1	7.3		7.7	8.2	8.2	8.6	8.8	9.5	8.6	9.0	9.3
164	5.5	5.7		6.0	6.2		6.6	6.8		7.3	7.7	8.2	7.5	7.9	8.2
171	4.6			4.9	5.1		5.5	5.7		6.4	6.6	7.1	6.4	6.8	7.1
184				3.1			3.7	4.0		4.4	4.6		4.6	4.9	4.9
197										2.9	3.1		2.9	3.1	

		 HYDRO	 27.2 ft	 360°	77,161 lbs	lbs x 1,000	SAE
---	---	---	---	--	-------------------	-------------	------------

 ft	43.4 ft + 3.7 ft + 15.3 ft			112.0 ft + 3.7 ft + 15.3 ft			125.7 ft + 3.7 ft + 15.3 ft			139.4 ft + 3.7 ft + 15.3 ft			153.1 ft + 3.7 ft + 15.3 ft		
	0°	20°	40°	0°	20°	40°	0°	20°	40°	0°	20°	40°	0°	20°	40°
9.8	105.4														
11.5	99.6	67.2													
13.1	94.4	65.0													
14.8	89.9	63.1	50.0												
16.4	85.8	61.1	48.9												
19.7	78.5	57.8	47.4	85.3											
23.0	72.5	54.9	45.9	85.3			66.8								
26.2	67.5	52.5	44.5	85.3	63.3		66.8			52.9			43.7		
29.5	63.1	50.3	43.4	85.3	61.5	47.6	66.8	63.7		52.9	52.9		43.7		
32.8	59.3	48.3	42.5	84.9	59.7	47.0	66.8	61.9	47.8	52.9	52.9		43.7	37.5	
36.1	56.2	46.7	41.4	80.2	58.2	46.3	66.8	60.4	47.2	52.9	52.9	47.8	42.3	36.2	32.6
39.4	53.1	44.5	40.6	76.1	56.9	45.6	66.8	59.1	46.5	52.9	52.9	47.2	40.6	35.1	31.7
45.9	45.9	41.0		68.8	54.2	44.3	63.7	56.4	45.4	52.9	52.0	46.1	37.7	32.8	30.0
52.5	40.1			56.0	51.8	43.4	58.0	54.0	44.3	50.0	48.3	45.0	35.1	31.1	28.4
59.1				45.4	47.4	42.5	48.1	49.8	43.4	46.5	45.0	44.1	33.1	29.3	27.1
65.6				37.5	39.2	40.1	40.1	41.7	42.5	39.7	41.2	41.4	31.3	28.0	26.0
72.2				31.1	32.6	33.5	33.7	35.1	35.9	33.5	34.6	35.5	29.8	26.9	25.1
78.7				25.8	27.1	27.8	28.4	29.8	30.4	28.2	29.3	30.2	28.4	25.8	24.3
85.3				21.4	22.5	23.1	24.3	25.4	25.8	23.8	24.7	25.6	25.1	24.9	23.6
91.9				17.9	18.7	19.2	20.5	21.4	21.8	20.1	20.9	21.6	21.4	22.5	22.9
98.4				14.8	15.4	15.7	17.4	18.3	18.5	17.0	17.6	18.3	18.3	19.4	19.8
105				12.1	12.8		14.8	15.4	15.7	14.3	15.0	15.4	15.7	16.5	17.0
112				9.9	10.4		12.3	13.0		11.9	12.6	12.8	13.2	14.1	14.3
118				7.9			10.4	10.8		9.9	10.4	10.6	11.2	11.9	12.1
125							8.6	9.0		8.2	8.6		9.5	9.9	10.1
131							7.1			6.6	6.8		7.7	8.4	
138										5.1	5.3		6.4	6.8	
144										4.0	4.0		5.1	5.5	
151													4.0	4.2	
158													2.9		

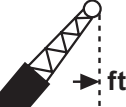
 ft	166.9 ft + 3.7 ft + 15.3 ft			180.6 ft + 3.7 ft + 15.3 ft			194.3 ft + 3.7 ft + 15.3 ft			208.0 ft + 3.7 ft + 15.3 ft			223.1 ft + 3.7 ft + 15.3 ft		
	0°	20°	40°	0°	20°	40°	0°	20°	40°	0°	20°	40°	0°	20°	40°
32.8	39.2														
36.1	39.2	34.8		34.2											
39.4	37.9	33.7		34.2	30.9		28.4								
45.9	35.5	31.7	29.1	32.4	29.3	27.1	28.4	26.5		24.0	22.3		22.0		
52.5	33.5	30.0	27.8	30.6	27.8	25.8	27.1	25.1	23.8	22.7	21.2	20.3	20.7	19.4	
59.1	31.7	28.4	26.5	29.1	26.5	24.7	25.6	24.0	22.9	21.6	20.3	19.4	19.8	18.5	17.9
65.6	30.0	27.1	25.4	27.8	25.4	23.6	24.5	22.9	22.0	20.5	19.2	18.5	19.0	17.6	17.2
72.2	28.4	25.8	24.3	26.7	24.3	22.7	23.1	22.0	21.2	19.6	18.5	17.9	18.1	17.0	16.3
78.7	27.3	24.9	23.4	25.4	23.1	22.0	22.3	21.2	20.3	18.7	17.6	17.0	17.2	16.3	15.7
85.3	25.4	23.8	22.7	24.3	22.3	21.2	21.4	20.3	19.6	18.1	17.0	16.5	16.5	15.7	15.2
91.9	21.6	22.5	21.8	22.0	21.6	20.5	20.5	19.4	19.0	17.2	16.5	15.9	15.9	15.2	14.8
98.4	18.5	19.4	19.8	19.0	19.6	19.8	19.6	18.7	18.3	16.5	15.9	15.4	15.2	14.8	14.3
105	15.7	16.5	17.0	16.1	17.0	17.4	16.8	17.6	17.9	15.9	15.4	15.0	14.6	14.1	13.9
112	13.4	14.1	14.6	13.9	14.6	15.0	14.6	15.2	15.7	15.2	14.8	14.6	14.1	13.7	13.4
118	11.2	11.9	12.3	11.7	12.3	12.8	12.3	13.0	13.4	13.2	13.9	14.1	13.4	13.2	13.0
125	9.5	10.1	10.4	9.9	10.6	10.8	10.6	11.2	11.5	11.5	11.9	12.8	11.7	12.3	12.6
131	7.9	8.4	8.6	8.4	8.8	9.0	9.0	9.5	9.7	9.7	10.4	11.0	9.9	10.6	11.0
138	6.4	6.8		6.8	7.3	7.5	7.5	7.9	8.2	8.4	8.8	9.5	8.6	9.0	9.5
144	5.1	5.5		5.5	6.0	6.2	6.2	6.6	6.8	7.1	7.5	7.9	7.3	7.7	7.9
151	4.0	4.2		4.4	4.6		5.1	5.3	5.5	5.7	6.2	6.8	6.0	6.4	6.6
158	2.9	3.1		3.3	3.5		4.0	4.2	4.4	4.6	5.1	5.5	4.9	5.3	5.5
164					2.4		2.9	3.3		3.7	4.0	4.4	4.0	4.2	4.4
171										2.9	3.1	3.5			3.5

Lifting capacities / Capacidades de elevación

					51,808 lbs	lbs x 1,000	SAE
---	---	---	---	---	-------------------	-------------	------------

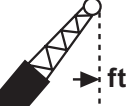
 ft	43.4 ft + 3.7 ft + 15.3 ft			112.0 ft + 3.7 ft + 15.3 ft			125.7 ft + 3.7 ft + 15.3 ft			139.4 ft + 3.7 ft + 15.3 ft			153.1 ft + 3.7 ft + 15.3 ft		
	0°	20°	40°	0°	20°	40°	0°	20°	40°	0°	20°	40°	0°	20°	40°
9.8	105.4														
11.5	99.6	67.2													
13.1	94.4	65.0													
14.8	89.9	63.1	50.0												
16.4	85.8	61.1	48.9												
19.7	78.5	57.8	47.4	85.3											
23.0	72.5	54.9	45.9	85.3			66.8								
26.2	67.5	52.5	44.5	85.3	63.3		66.8			52.9			43.7		
29.5	63.1	50.3	43.4	85.3	61.5	47.6	66.8	63.7		52.9	52.9		43.7		
32.8	59.3	48.3	42.5	84.9	59.7	47.0	66.8	61.9	47.8	52.9	52.9		43.7	37.5	
36.1	56.2	46.7	41.4	77.6	58.2	46.3	66.8	60.4	47.2	52.9	52.9	47.8	42.3	36.2	32.6
39.4	53.1	44.5	40.6	68.6	56.9	45.6	66.8	59.1	46.5	52.9	52.9	47.2	40.6	35.1	31.7
45.9	45.9	41.0		54.9	54.2	44.3	56.4	56.4	45.4	52.9	52.0	46.1	37.7	32.8	30.0
52.5	40.1			43.7	46.1	43.4	46.5	48.5	44.3	44.5	46.5	45.0	35.1	31.1	28.4
59.1				34.8	36.8	38.1	37.5	39.2	40.6	37.0	38.8	40.1	33.1	29.3	27.1
65.6				27.8	29.8	30.9	30.6	32.4	33.3	30.4	31.7	32.8	31.3	28.0	26.0
72.2				22.0	23.6	24.7	24.9	26.5	27.6	24.5	26.0	27.1	26.0	26.9	25.1
78.7				17.4	19.0	19.6	20.3	21.6	22.5	19.8	21.2	22.0	21.4	22.7	23.6
85.3				13.7	15.0	15.4	16.5	17.6	18.3	16.1	17.2	17.9	17.4	18.7	19.6
91.9				10.6	11.7	12.1	13.4	14.6	15.0	13.0	13.9	14.6	14.3	15.4	16.1
98.4				8.2	8.8	9.0	10.8	11.7	12.1	10.4	11.2	11.7	11.7	12.8	13.2
105				6.0	6.4		8.6	9.3	9.5	8.2	8.8	9.3	9.5	10.4	10.8
112				4.0	4.4		6.6	7.3		6.2	6.6	7.1	7.5	8.2	8.6
118				2.4			4.9	5.3		4.4	4.9	5.1	5.7	6.4	6.8
125							3.5	3.7		2.9	3.3		4.2	4.9	5.1
131													2.9	3.3	

 ft	166.9 ft + 3.7 ft + 15.3 ft			180.6 ft + 3.7 ft + 15.3 ft			194.3 ft + 3.7 ft + 15.3 ft			208.0 ft + 3.7 ft + 15.3 ft			223.1 ft + 3.7 ft + 15.3 ft		
	0°	20°	40°	0°	20°	40°	0°	20°	40°	0°	20°	40°	0°	20°	40°
32.8	39.2														
36.1	39.2	34.8		34.2											
39.4	37.9	33.7		34.2	30.9		28.4								
45.9	35.5	31.7	29.1	32.4	29.3	27.1	28.4	26.5		24.0	22.3		22.0		
52.5	33.5	30.0	27.8	30.6	27.8	25.8	27.1	25.1	23.8	22.7	21.2	20.3	20.7	19.4	
59.1	31.7	28.4	26.5	29.1	26.5	24.7	25.6	24.0	22.9	21.6	20.3	19.4	19.8	18.5	17.9
65.6	30.0	27.1	25.4	27.8	25.4	23.6	24.5	22.9	22.0	20.5	19.2	18.5	19.0	17.6	17.2
72.2	26.2	25.8	24.3	26.2	24.3	22.7	23.1	22.0	21.2	19.6	18.5	17.9	18.1	17.0	16.3
78.7	21.6	22.9	23.4	22.0	23.1	22.0	22.3	21.2	20.3	18.7	17.6	17.0	17.2	16.3	15.7
85.3	17.9	19.0	19.6	18.3	19.4	20.1	19.0	20.1	19.6	18.1	17.0	16.5	16.5	15.7	15.2
91.9	14.6	15.7	16.3	15.0	16.1	16.8	15.7	16.8	17.4	16.5	16.5	15.9	15.9	15.2	14.8
98.4	11.9	12.8	13.4	12.3	13.2	13.9	13.0	13.9	14.6	13.9	14.8	15.4	14.3	14.8	14.3
105	9.7	10.4	10.8	9.9	10.8	11.2	10.8	11.5	12.1	11.5	12.3	13.4	11.9	12.8	13.2
112	7.5	8.4	8.8	7.9	8.8	9.3	8.6	9.5	9.9	9.5	10.1	11.2	9.9	10.6	11.0
118	6.0	6.4	6.8	6.2	6.8	7.3	7.1	7.5	7.9	7.7	8.4	9.3	8.2	8.8	9.3
125	4.4	4.9	5.1	4.9	5.3	5.7	5.5	6.0	6.4	6.2	6.8	7.7	6.6	7.1	7.5
131		3.5	3.7			4.2		4.6	4.9	4.9	5.3	6.2	6.2	5.7	6.2
138												4.9			

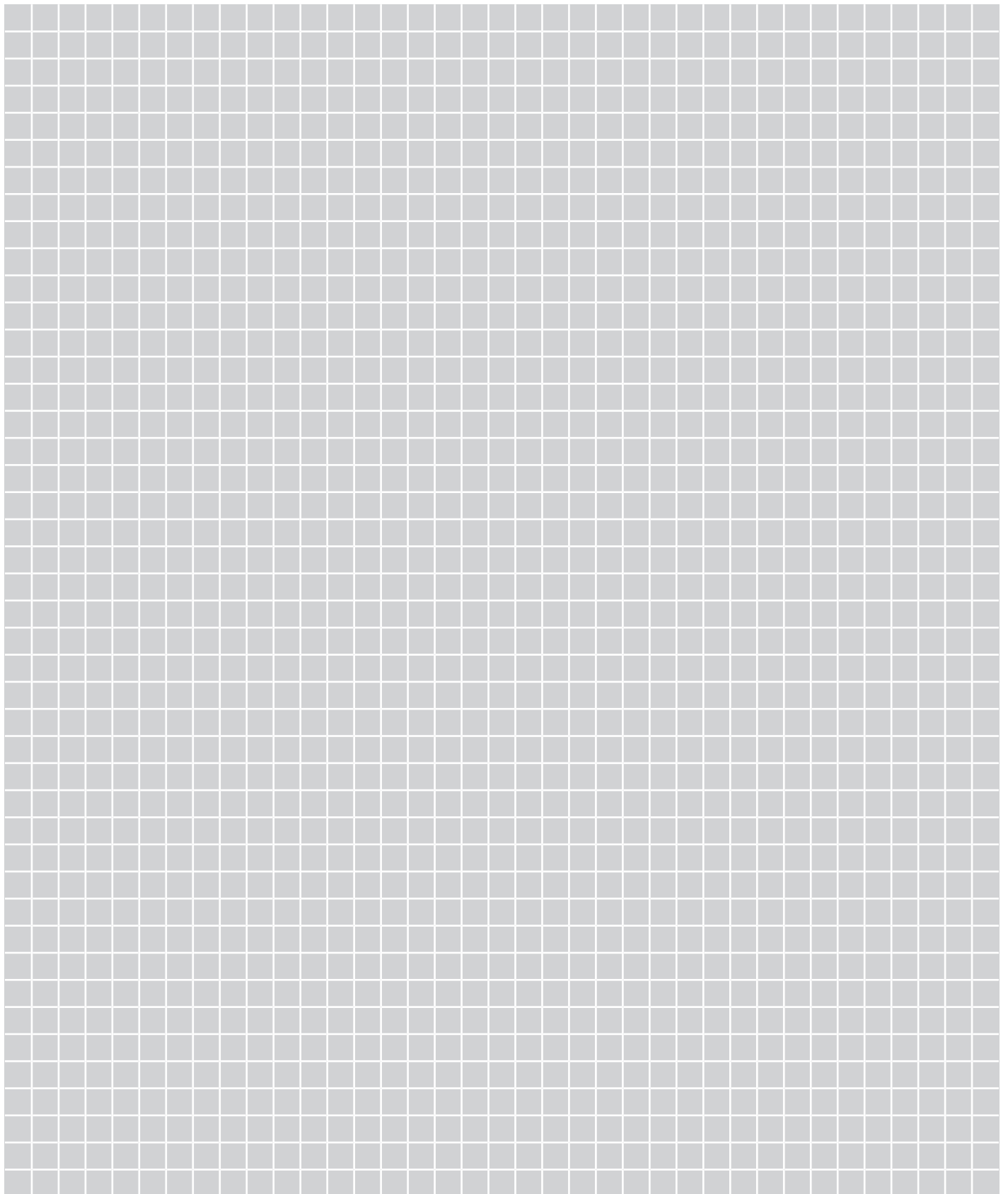

Lifting heights / Alturas de elevación

					156,527 lbs	lbs x 1,000	SAE
--	--	--	--	--	--------------------	-------------	------------

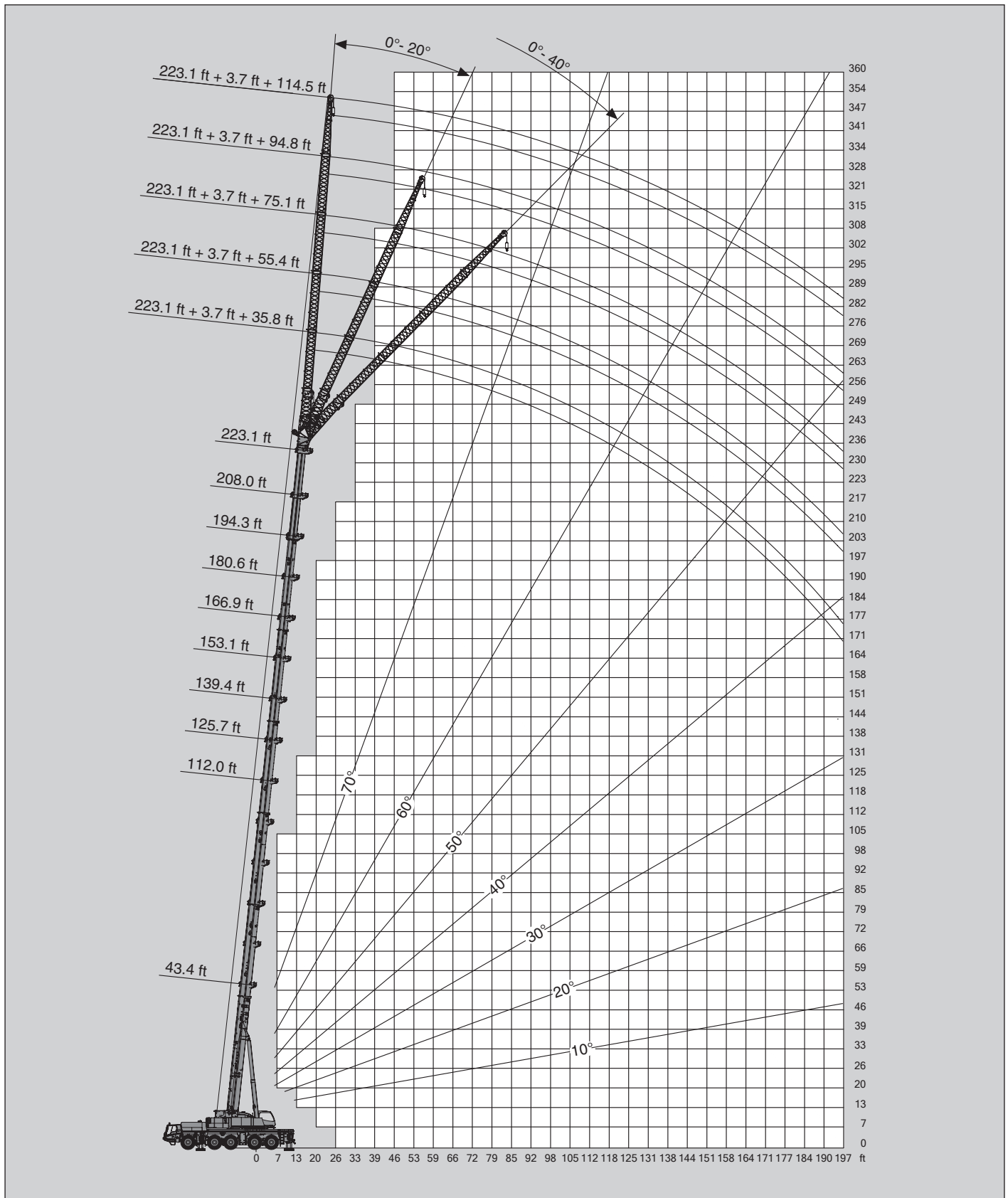

		 HYDRO	 27.2 ft	 360°	156,527 lbs	lbs x 1,000	SAE
---	---	---	---	--	--------------------	-------------	------------

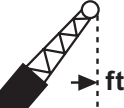
 ft	43.4 ft + 3.7 ft + 35.8 ft			112.0 ft + 3.7 ft + 35.8 ft			166.9 ft + 3.7 ft + 35.8 ft			208.0 ft + 3.7 ft + 35.8 ft			223.1 ft + 3.7 ft + 35.8 ft		
	0°	20°	40°	0°	20°	40°	0°	20°	40°	0°	20°	40°	0°	20°	40°
9.8	43.4														
11.5	43.2														
13.1	42.1														
14.8	41.0														
16.4	39.7														
19.7	37.5	31.1		41.9											
23.0	35.3	29.1		40.6											
26.2	33.3	27.3		39.2											
29.5	31.5	25.6	21.4	38.1											
32.8	29.8	24.3	20.5	36.8	29.3		28.9								
36.1	28.4	23.1	19.6	35.7	28.4		28.9								
39.4	27.1	22.0	19.0	34.6	27.3		28.9								
45.9	24.3	20.1	17.9	32.4	25.6	20.3	28.7	23.8		16.5					
52.5	21.6	18.5	17.0	30.6	24.3	19.6	26.9	22.7		16.5			14.6		
59.1	19.4	17.4	16.3	28.9	22.9	19.0	25.6	21.6	19.2	16.5	16.1		14.6		
65.6	17.6	16.5		27.3	21.6	18.3	24.3	20.5	18.5	16.5	15.4		14.6	14.3	
72.2	16.3	15.9		26.0	20.7	17.9	23.1	19.6	17.9	15.9	14.8	13.7	14.6	13.7	12.8
78.7				24.9	19.8	17.4	22.0	18.7	17.2	15.2	14.1	13.2	14.1	13.2	12.3
85.3				23.8	19.0	17.0	21.2	18.1	16.5	14.8	13.4	12.8	13.4	12.6	11.9
91.9				22.3	18.3	16.5	20.1	17.4	16.1	14.3	13.0	12.3	13.2	12.1	11.5
98.4				21.2	17.6	16.3	19.2	16.8	15.7	13.7	12.6	11.9	12.8	11.7	11.0
105				20.1	17.2	16.1	18.5	16.1	15.2	13.2	12.1	11.5	12.1	11.2	10.8
112				19.0	16.8	15.9	17.9	15.7	14.8	12.8	11.7	11.2	11.7	11.0	10.4
118				18.1	16.3		17.2	15.2	14.3	12.3	11.5	10.8	11.5	10.6	10.1
125				17.4	16.1		16.8	14.8	14.1	11.9	11.0	10.6	11.0	10.4	9.7
131				16.8	15.9		16.1	14.3	13.7	11.5	10.8	10.1	10.6	9.9	9.5
138				16.1			15.7	14.1	13.4	11.2	10.6	9.9	10.4	9.7	9.3
144							15.4	13.7	13.2	10.8	10.1	9.7	9.9	9.5	9.0
151							15.0	13.4	13.0	10.6	9.9	9.5	9.7	9.3	8.8
158							14.1	13.2	12.8	10.1	9.7	9.5	9.5	9.0	8.6
164							13.4	13.0		9.9	9.5	9.3	9.3	8.8	8.6
171							12.6	12.8		9.7	9.3	9.0	8.8	8.6	8.4
184							10.4	10.8		8.8	8.8	8.6	8.4	8.2	7.9
197							7.3			7.9	7.9		7.7	7.7	7.7
210										7.1	7.3		6.8	7.1	
223										6.4	6.6		6.2	6.2	
236										5.3			4.9	5.1	
249													3.7		

Lifting capacities / Capacidades de elevación

		 HYDRO	 27.2 ft	 360°	156,527 lbs	lbs x 1,000	SAE
---	---	--	--	---	--------------------	-------------	------------

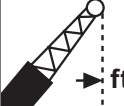
 ft	43.4 ft + 3.7 ft + 55.4 ft			112.0 ft + 3.7 ft + 55.4 ft			166.9 ft + 3.7 ft + 55.4 ft			208.0 ft + 3.7 ft + 55.4 ft			223.1 ft + 3.7 ft + 55.4 ft		
	0°	20°	40°	0°	20°	40°	0°	20°	40°	0°	20°	40°	0°	20°	40°
9.8	38.8														
11.5	38.1														
13.1	37.5														
14.8	36.8														
16.4	35.9														
19.7	34.2														
23.0	32.6				32.2										
26.2	31.1				32.2										
29.5	29.8	24.5			31.7										
32.8	28.2	22.9			30.9										
36.1	27.1	21.4			30.0		18.3								
39.4	25.6	20.1			29.3		18.3								
45.9	22.0	17.9	15.0		27.8	22.0	18.3								
52.5	19.2	16.1	13.7	26.5	20.7	18.3			12.3						
59.1	17.0	14.8	12.8	25.1	19.4	14.6	18.3	17.2	12.3				11.2		
65.6	15.2	13.4	11.9	24.0	18.3	13.9	18.3	16.3	12.3				11.2		
72.2	13.9	12.6	11.2	22.9	17.2	13.2	18.3	15.7	12.3	12.1			11.2		
78.7	12.6	11.7	10.6	21.2	16.1	12.8	17.9	15.0	13.2	12.3	11.5		11.2	10.8	
85.3	11.5	10.8		19.6	15.2	12.3	17.2	14.6	13.0	12.3	11.0		11.2	10.4	
91.9	10.6	10.4		18.3	14.3	11.9	16.5	13.9	12.6	11.9	10.8	9.9	11.0	10.1	9.3
98.4				17.0	13.7	11.5	15.9	13.4	12.1	11.5	10.4	9.5	10.6	9.7	9.0
105				15.9	13.0	11.2	15.2	13.0	11.9	11.0	9.9	9.3	10.1	9.3	8.6
112				15.0	12.6	10.8	14.6	12.6	11.5	10.8	9.7	9.0	10.1	9.0	8.4
118				14.1	11.9	10.6	14.1	12.3	11.2	10.4	9.3	8.6	9.7	8.8	8.2
125				13.4	11.5	10.4	13.7	11.9	11.0	10.1	9.0	8.4	9.3	8.4	7.9
131				12.8	11.0	10.1	13.2	11.7	10.8	9.7	8.8	8.2	9.0	8.2	7.7
138				12.1	10.8		12.8	11.2	10.4	9.5	8.4	7.9	8.8	7.9	7.5
144				11.5	10.4		12.6	11.0	10.1	9.0	8.2	7.7	8.4	7.7	7.3
151				11.0	10.1		12.1	10.8	10.1	8.8	7.9	7.7	8.2	7.5	7.1
158				10.6			11.9	10.6	9.9	8.6	7.7	7.5	7.9	7.3	6.8
164							11.7	10.4	9.7	8.4	7.5	7.3	7.7	7.1	6.6
171							11.5	10.1	9.5	8.2	7.5	7.1	7.5	6.8	6.6
184							10.6	9.9		7.7	7.1	6.8	7.1	6.6	6.4
197							9.3	9.7		7.1	6.8	6.6	6.6	6.4	6.2
210							7.5			6.4	6.4	6.4	6.2	6.0	6.0
223										5.7	6.0		5.5	5.7	
236										5.3	5.3		4.9	5.1	
249										4.2			4.0	4.4	
263													2.9		

		 HYDRO	 27.2 ft	 360°	156,527 lbs	lbs x 1,000	SAE
---	---	---	---	--	--------------------	-------------	------------

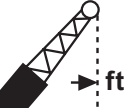
 ft	43.4 ft + 3.7 ft + 75.1 ft			112.0 ft + 3.7 ft + 75.1 ft			166.9 ft + 3.7 ft + 75.1 ft			208.0 ft + 3.7 ft + 75.1 ft			223.1 ft + 3.7 ft + 75.1 ft		
	0°	20°	40°	0°	20°	40°	0°	20°	40°	0°	20°	40°	0°	20°	40°
11.5	24.5														
13.1	24.5														
14.8	24.5														
16.4	24.0														
19.7	23.1														
23.0	22.3														
26.2	21.4				19.6										
29.5	20.5				19.6										
32.8	19.6				19.6										
36.1	19.0				19.6										
39.4	18.1	16.8			19.6										
45.9	16.8	15.0			19.0		13.2								
52.5	15.4	13.4			18.1		13.2								
59.1	14.1	12.1			17.2	14.3	13.2								
65.6	12.6	11.0	9.5	16.3	13.4		13.2			9.5			8.8		
72.2	11.2	10.1	8.8	15.7	13.0		13.2	12.1		9.5			8.8		
78.7	10.4	9.3	8.4	15.0	12.1	9.3	13.2	11.7		9.5			8.8		
85.3	9.5	8.6	7.7	14.3	11.5	9.0	13.2	11.5		9.5	9.3		8.8		
91.9	8.6	7.9	7.5	13.7	10.8	8.6	13.0	11.0	8.8	9.5	8.8		8.8	8.4	
98.4	8.2	7.5	7.1	13.0	10.4	8.4	12.6	10.6	8.6	9.5	8.6		8.8	7.9	
105	7.5	7.1		12.6	9.7	7.9	12.3	10.4	8.4	9.5	8.2	7.5	8.6	7.7	
112	7.1	6.6		11.9	9.3	7.7	11.9	10.1	8.2	9.0	7.9	7.3	8.4	7.5	6.8
118				11.2	8.8	7.5	11.7	9.9	7.9	8.6	7.7	7.1	7.9	7.3	6.6
125				10.6	8.6	7.3	11.2	9.5	7.7	8.4	7.5	6.8	7.7	7.1	6.4
131				9.9	8.2	7.1	10.8	9.3	7.7	8.2	7.1	6.6	7.5	6.8	6.2
138				9.3	7.9	7.1	10.6	9.0	7.5	7.9	6.8	6.4	7.3	6.6	6.2
144				8.8	7.5	6.8	10.1	8.6	7.3	7.5	6.6	6.2	7.1	6.4	6.0
151				8.4	7.3	6.6	9.9	8.4	7.1	7.3	6.6	6.2	6.8	6.2	5.7
158				7.9	7.1		9.7	8.2	7.1	7.1	6.4	6.0	6.6	6.0	5.5
164				7.5	6.8		9.5	7.9	6.8	6.8	6.2	5.7	6.4	5.7	5.5
171				7.1	6.6		9.0	7.7	6.8	6.6	6.0	5.7	6.2	5.5	5.3
184							8.6	7.3	6.6	6.4	5.7	5.3	6.0	5.3	5.1
197							7.9	7.1	6.6	6.0	5.3	5.1	5.5	5.1	4.9
210							7.5	6.6		5.5	5.1	4.9	5.3	4.9	4.4
223							6.4	6.4		5.3	4.9	4.6	4.9	4.6	4.4
236										4.6	4.6		4.4	4.4	4.2
249										4.0	4.2		3.7	4.2	
263										3.3	3.7		3.1	3.5	
276										2.4			2.4		

Lifting capacities / Capacidades de elevación







156,527 lbs

lbs x 1,000

SAE

ft	43.4 ft + 3.7 ft + 94.8 ft			112.0 ft + 3.7 ft + 94.8 ft			166.9 ft + 3.7 ft + 94.8 ft			208.0 ft + 3.7 ft + 94.8 ft			223.1 ft + 3.7 ft + 94.8 ft		
	0°	20°	40°	0°	20°	40°	0°	20°	40°	0°	20°	40°	0°	20°	40°
16.4	14.3														
19.7	14.3														
23.0	14.3														
26.2	14.3														
29.5	14.3			13.7											
32.8	14.3			13.7											
36.1	14.1			13.7											
39.4	13.7			13.7											
45.9	12.8			13.4											
52.5	11.9	10.8		12.8			9.7								
59.1	11.0	9.9		12.3			9.7								
65.6	10.4	9.3		11.9	9.9		9.7			7.3			6.8		
72.2	9.7	8.6		11.5	9.5		9.7			7.3			6.8		
78.7	9.0	7.9	6.8	10.8	9.0		9.7	8.6		7.3			6.8		
85.3	8.4	7.3	6.4	10.4	8.6		9.5	8.2		7.3			6.8		
91.9	7.5	6.6	6.0	9.9	8.4	6.6	9.3	7.9		7.3			6.8		
98.4	6.8	6.2	5.5	9.5	7.9	6.4	9.0	7.7		7.3	6.8		6.8		
105	6.4	5.7	5.3	9.3	7.7	6.2	8.8	7.5		7.3	6.6		6.8	6.4	
112	5.7	5.3	5.1	8.8	7.3	5.7	8.6	7.3	6.0	7.3	6.6		6.8	6.2	
118	5.3	5.1	4.9	8.6	6.8	5.5	8.4	7.1	6.0	7.3	6.4		6.8	6.0	
125	5.1	4.9		8.2	6.6	5.5	8.2	6.8	5.7	7.1	6.2	5.5	6.6	5.7	
131	4.6	4.4		7.9	6.2	5.3	7.9	6.6	5.5	6.8	6.0	5.3	6.4	5.5	5.1
138				7.3	6.0	5.1	7.7	6.4	5.3	6.6	5.7	5.3	6.2	5.3	4.9
144				6.8	5.7	4.9	7.5	6.4	5.3	6.4	5.5	5.1	6.0	5.3	4.9
151				6.6	5.5	4.9	7.3	6.2	5.1	6.2	5.3	4.9	5.5	5.1	4.6
158				6.2	5.3	4.6	7.1	6.0	5.1	6.0	5.1	4.9	5.3	4.9	4.4
164				6.0	5.1	4.6	7.1	6.0	4.9	5.7	5.1	4.6	5.3	4.6	4.4
171				5.5	4.9	4.4	6.8	5.7	4.9	5.5	4.9	4.4	5.1	4.4	4.2
184				5.1	4.6		6.4	5.3	4.6	5.1	4.6	4.2	4.9	4.2	4.0
197				4.6			6.0	5.1	4.4	4.9	4.2	4.0	4.4	4.0	3.7
210							5.5	4.9	4.4	4.4	4.0	3.7	4.2	3.7	3.5
223							5.1	4.6		4.2	3.7	3.5	4.0	3.5	3.3
236							4.9	4.4		3.7	3.5	3.3	3.7	3.3	3.1
249							4.4			3.5	3.3	3.1	3.3	3.1	2.9
263										3.1	3.1		2.9	2.9	
276										2.4	2.9		2.6		

		 HYDRO	 27.2 ft	 360°	156,527 lbs	lbs x 1,000	SAE
---	---	---	---	--	--------------------	-------------	------------

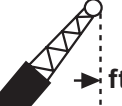
 ft	43.4 ft + 3.7 ft + 114.5 ft			112.0 ft + 3.7 ft + 114.5 ft			166.9 ft + 3.7 ft + 114.5 ft			208.0 ft + 3.7 ft + 114.5 ft			223.1 ft + 3.7 ft + 114.5 ft		
	0°	20°	40°	0°	20°	40°	0°	20°	40°	0°	20°	40°	0°	20°	40°
19.7	10.4														
23.0	10.4														
26.2	10.4														
29.5	10.4														
32.8	10.4														
36.1	10.4			9.9											
39.4	9.9			9.9											
45.9	9.5			9.5											
52.5	8.8			9.3											
59.1	8.4			8.8											
65.6	7.9	7.3		8.4			7.3			5.7				5.3	
72.2	7.5	6.8		8.2			7.1			5.7				5.3	
78.7	7.1	6.4		7.7	6.6		6.8			5.5				5.3	
85.3	6.6	6.0		7.5	6.4		6.6			5.5				5.1	
91.9	6.2	5.7		7.3	6.2		6.4	5.5		5.3				5.1	
98.4	6.0	5.3	4.6	6.8	6.0		6.4	5.3		5.3				4.9	
105	5.5	4.9	4.2	6.6	5.7		6.2	5.3		5.1				4.9	
112	4.9	4.4	4.0	6.4	5.5	4.4	6.0	5.1		5.1	4.4			4.9	
118	4.6	4.2	3.7	6.2	5.3	4.2	5.7	4.9		5.1	4.4			4.6	
125	4.2	3.7	3.5	6.0	5.1	4.0	5.7	4.9		4.9	4.2			4.6	
131	3.7	3.5	3.3	5.7	4.9	4.0	5.5	4.6	4.0	4.9	4.2			4.6	
138	3.5	3.3	3.1	5.5	4.6	3.7	5.3	4.6	4.0	4.6	4.0			4.4	
144	3.3	3.1		5.3	4.4	3.5	5.3	4.4	3.7	4.6	4.0			4.4	
151	2.9	2.9		5.3	4.2	3.5	5.1	4.4	3.7	4.4	4.0			4.2	
158				4.9	4.0	3.3	5.1	4.2	3.5	4.4	3.7			4.2	
164				4.6	3.7	3.3	4.9	4.2	3.5	4.4	3.7			4.2	
171				4.4	3.5	3.1	4.6	4.0	3.3	4.2	3.7			4.0	
184				4.0	3.3	3.1	4.4	3.7	3.3	4.0	3.5			3.7	
197				3.5	3.1		4.4	3.5	3.1	3.7	3.3			3.5	
210				3.1	2.9		4.2	3.3	2.9	3.5	3.1			3.3	
223							3.7	3.1	2.9	3.3	2.9			2.9	
236							3.5	3.1	2.9	2.9	2.6			2.6	
249							3.3	2.9		2.4	2.2			2.4	
263							2.9	2.9		2.2				2.2	

Lifting capacities / Capacidades de elevación









103,616 lbs

lbs x 1,000

SAE

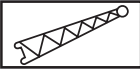
ft	43.4 ft + 3.7 ft + 35.8 ft			112.0 ft + 3.7 ft + 35.8 ft			166.9 ft + 3.7 ft + 35.8 ft			208.0 ft + 3.7 ft + 35.8 ft			223.1 ft + 3.7 ft + 35.8 ft		
	0°	20°	40°	0°	20°	40°	0°	20°	40°	0°	20°	40°	0°	20°	40°
9.8	43.4														
11.5	43.2														
13.1	42.1														
14.8	41.0														
16.4	39.7														
19.7	37.5	31.1		41.9											
23.0	35.3	29.1		40.6											
26.2	33.3	27.3		39.2											
29.5	31.5	25.6	21.4	38.1											
32.8	29.8	24.3	20.5	36.8	29.3		28.9								
36.1	28.4	23.1	19.6	35.7	28.4		28.9								
39.4	27.1	22.0	19.0	34.6	27.3		28.9								
45.9	24.3	20.1	17.9	32.4	25.6	20.3	28.7	23.8		16.5					
52.5	21.6	18.5	17.0	30.6	24.3	19.6	26.9	22.7		16.5			14.6		
59.1	19.4	17.4	16.3	28.9	22.9	19.0	25.6	21.6	19.2	16.5	16.1		14.6		
65.6	17.6	16.5		27.3	21.6	18.3	24.3	20.5	18.5	16.5	15.4		14.6	14.3	
72.2	16.3	15.9		26.0	20.7	17.9	23.1	19.6	17.9	15.9	14.8	13.7	14.6	13.7	12.8
78.7				24.9	19.8	17.4	22.0	18.7	17.2	15.2	14.1	13.2	14.1	13.2	12.3
85.3				23.8	19.0	17.0	21.2	18.1	16.5	14.8	13.4	12.8	13.4	12.6	11.9
91.9				22.3	18.3	16.5	20.1	17.4	16.1	14.3	13.0	12.3	13.2	12.1	11.5
98.4				21.2	17.6	16.3	19.2	16.8	15.7	13.7	12.6	11.9	12.8	11.7	11.0
105				20.1	17.2	16.1	18.5	16.1	15.2	13.2	12.1	11.5	12.1	11.2	10.8
112				17.9	16.8	15.9	17.9	15.7	14.8	12.8	11.7	11.2	11.7	11.0	10.4
118				15.7	16.3		17.2	15.2	14.3	12.3	11.5	10.8	11.5	10.6	10.1
125				13.7	14.6		15.4	14.8	14.1	11.9	11.0	10.6	11.0	10.4	9.7
131				11.7	12.6		13.7	14.3	13.7	11.5	10.8	10.1	10.6	9.9	9.5
138				10.1			11.9	13.0	13.4	11.2	10.6	9.9	10.4	9.7	9.3
144							10.4	11.5	12.6	10.8	10.1	9.7	9.9	9.5	9.0
151							9.0	9.9	10.8	10.6	9.9	9.5	9.7	9.3	8.8
158							7.9	8.6	9.5	9.5	9.7	9.5	9.3	9.0	8.6
164							6.8	7.5		8.4	9.3	9.3	7.9	8.8	8.6
171							5.7	6.4		7.3	8.2	8.6	7.1	7.9	8.4
184							4.0	4.4		5.3	6.2	6.4	5.1	6.0	6.4
197							2.6			3.7	4.4		3.5	4.2	4.6
210										2.4	2.9			2.6	

					103,616 lbs	lbs x 1,000	SAE
---	---	---	---	---	--------------------	-------------	------------

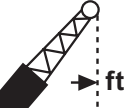
 ft	43.4 ft + 3.7 ft + 55.4 ft			112.0 ft + 3.7 ft + 55.4 ft			166.9 ft + 3.7 ft + 55.4 ft			208.0 ft + 3.7 ft + 55.4 ft			223.1 ft + 3.7 ft + 55.4 ft		
	0°	20°	40°	0°	20°	40°	0°	20°	40°	0°	20°	40°	0°	20°	40°
9.8	38.8														
11.5	38.1														
13.1	37.5														
14.8	36.8														
16.4	35.9														
19.7	34.2														
23.0	32.6														
26.2	31.1														
29.5	29.8	24.5													
32.8	28.2	22.9													
36.1	27.1	21.4													
39.4	25.6	20.1													
45.9	22.0	17.9	15.0												
52.5	19.2	16.1	13.7												
59.1	17.0	14.8	12.8												
65.6	15.2	13.4	11.9												
72.2	13.9	12.6	11.2												
78.7	12.6	11.7	10.6												
85.3	11.5	10.8													
91.9	10.6	10.4													
98.4															
105															
112															
118															
125															
131															
138															
144															
151															
158															
164															
171															
184															
197															
210															

Lifting capacities / Capacidades de elevación

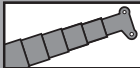





103,616 lbs

lbs x 1,000

SAE

ft	43.4 ft + 3.7 ft + 75.1 ft			112.0 ft + 3.7 ft + 75.1 ft			166.9 ft + 3.7 ft + 75.1 ft			208.0 ft + 3.7 ft + 75.1 ft			223.1 ft + 3.7 ft + 75.1 ft		
	0°	20°	40°	0°	20°	40°	0°	20°	40°	0°	20°	40°	0°	20°	40°
11.5	24.5														
13.1	24.5														
14.8	24.5														
16.4	24.0														
19.7	23.1														
23.0	22.3														
26.2	21.4			19.6											
29.5	20.5			19.6											
32.8	19.6			19.6											
36.1	19.0			19.6											
39.4	18.1	16.8		19.6											
45.9	16.8	15.0		19.0			13.2								
52.5	15.4	13.4		18.1			13.2								
59.1	14.1	12.1		17.2	14.3		13.2								
65.6	12.6	11.0	9.5	16.3	13.4		13.2			9.5			8.8		
72.2	11.2	10.1	8.8	15.7	13.0		13.2	12.1		9.5			8.8		
78.7	10.4	9.3	8.4	15.0	12.1	9.3	13.2	11.7		9.5			8.8		
85.3	9.5	8.6	7.7	14.3	11.5	9.0	13.2	11.5		9.5	9.3		8.8		
91.9	8.6	7.9	7.5	13.7	10.8	8.6	13.0	11.0	8.8	9.5	8.8		8.8	8.4	
98.4	8.2	7.5	7.1	13.0	10.4	8.4	12.6	10.6	8.6	9.5	8.6		8.8	7.9	
105	7.5	7.1		12.6	9.7	7.9	12.3	10.4	8.4	9.5	8.2	7.5	8.6	7.7	
112	7.1	6.6		11.9	9.3	7.7	11.9	10.1	8.2	9.0	7.9	7.3	8.4	7.5	6.8
118				11.2	8.8	7.5	11.7	9.9	7.9	8.6	7.7	7.1	7.9	7.3	6.6
125				10.6	8.6	7.3	11.2	9.5	7.7	8.4	7.5	6.8	7.7	7.1	6.4
131				9.9	8.2	7.1	10.8	9.3	7.7	8.2	7.1	6.6	7.5	6.8	6.2
138				9.3	7.9	7.1	10.6	9.0	7.5	7.9	6.8	6.4	7.3	6.6	6.2
144				8.8	7.5	6.8	10.1	8.6	7.3	7.5	6.6	6.2	7.1	6.4	6.0
151				8.4	7.3	6.6	9.9	8.4	7.1	7.3	6.6	6.2	6.8	6.2	5.7
158				7.9	7.1		9.5	8.2	7.1	7.1	6.4	6.0	6.6	6.0	5.5
164				7.5	6.8		8.4	7.9	6.8	6.8	6.2	5.7	6.4	5.7	5.5
171				6.8	6.6		7.3	7.7	6.8	6.6	6.0	5.7	6.2	5.5	5.3
184							5.3	6.8	6.6	6.0	5.7	5.3	5.7	5.3	5.1
197							3.7	4.9	5.5	4.4	5.3	5.1	4.0	5.1	4.9
210							2.4	3.3		3.1	4.2	4.9		4.0	4.4
223												3.3			

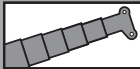
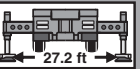

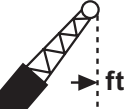

		 HYDRO	 27.2 ft	 360°	103,616 lbs	lbs x 1,000	SAE
---	---	---	---	--	--------------------	-------------	------------

 ft	43.4 ft + 3.7 ft + 94.8 ft			112.0 ft + 3.7 ft + 94.8 ft			166.9 ft + 3.7 ft + 94.8 ft			208.0 ft + 3.7 ft + 94.8 ft			223.1 ft + 3.7 ft + 94.8 ft		
	0°	20°	40°	0°	20°	40°	0°	20°	40°	0°	20°	40°	0°	20°	40°
16.4	14.3														
19.7	14.3														
23.0	14.3														
26.2	14.3														
29.5	14.3			13.7											
32.8	14.3			13.7											
36.1	14.1			13.7											
39.4	13.7			13.7											
45.9	12.8			13.4											
52.5	11.9	10.8		12.8			9.7								
59.1	11.0	9.9		12.3			9.7								
65.6	10.4	9.3		11.9	9.9		9.7			7.3			6.8		
72.2	9.7	8.6		11.5	9.5		9.7			7.3			6.8		
78.7	9.0	7.9	6.8	10.8	9.0		9.7	8.6		7.3			6.8		
85.3	8.4	7.3	6.4	10.4	8.6		9.5	8.2		7.3			6.8		
91.9	7.5	6.6	6.0	9.9	8.4	6.6	9.3	7.9		7.3			6.8		
98.4	6.8	6.2	5.5	9.5	7.9	6.4	9.0	7.7		7.3	6.8		6.8		
105	6.4	5.7	5.3	9.3	7.7	6.2	8.8	7.5		7.3	6.6		6.8	6.4	
112	5.7	5.3	5.1	8.8	7.3	5.7	8.6	7.3	6.0	7.3	6.6		6.8	6.2	
118	5.3	5.1	4.9	8.6	6.8	5.5	8.4	7.1	6.0	7.3	6.4		6.8	6.0	
125	5.1	4.9		8.2	6.6	5.5	8.2	6.8	5.7	7.1	6.2	5.5	6.6	5.7	
131	4.6	4.4		7.9	6.2	5.3	7.9	6.6	5.5	6.8	6.0	5.3	6.4	5.5	5.1
138				7.3	6.0	5.1	7.7	6.4	5.3	6.6	5.7	5.3	6.2	5.3	4.9
144				6.8	5.7	4.9	7.5	6.4	5.3	6.4	5.5	5.1	6.0	5.3	4.9
151				6.6	5.5	4.9	7.3	6.2	5.1	6.2	5.3	4.9	5.5	5.1	4.6
158				6.2	5.3	4.6	7.1	6.0	5.1	6.0	5.1	4.9	5.3	4.9	4.4
164				6.0	5.1	4.6	7.1	6.0	4.9	5.7	5.1	4.6	5.3	4.6	4.4
171				5.5	4.9	4.4	6.8	5.7	4.9	5.5	4.9	4.4	5.1	4.4	4.2
184				5.1	4.6		5.7	5.3	4.6	5.1	4.6	4.2	4.9	4.2	4.0
197				4.2			4.2	5.1	4.4	4.6	4.2	4.0	4.2	4.0	3.7
210							2.9	4.2	4.4		4.0	3.7		3.7	3.5
223								2.6				3.5			

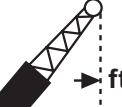
Lifting capacities / Capacidades de elevación

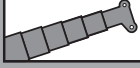
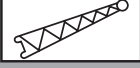

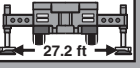
		 HYDRO	 27.2 ft	 360°	103,616 lbs	lbs x 1,000	SAE
---	---	---	---	--	--------------------	-------------	------------

 ft	43.4 ft + 3.7 ft + 114.5 ft			112.0 ft + 3.7 ft + 114.5 ft			166.9 ft + 3.7 ft + 114.5 ft			208.0 ft + 3.7 ft + 114.5 ft			223.1 ft + 3.7 ft + 114.5 ft		
	0°	20°	40°	0°	20°	40°	0°	20°	40°	0°	20°	40°	0°	20°	40°
19.7	10.4														
23.0	10.4														
26.2	10.4														
29.5	10.4														
32.8	10.4														
36.1	10.4			9.9											
39.4	9.9			9.9											
45.9	9.5			9.5											
52.5	8.8			9.3											
59.1	8.4			8.8											
65.6	7.9	7.3		8.4			7.3			5.7				5.3	
72.2	7.5	6.8		8.2			7.1			5.7				5.3	
78.7	7.1	6.4		7.7	6.6		6.8			5.5				5.3	
85.3	6.6	6.0		7.5	6.4		6.6			5.5				5.1	
91.9	6.2	5.7		7.3	6.2		6.4	5.5		5.3				5.1	
98.4	6.0	5.3	4.6	6.8	6.0		6.4	5.3		5.3				4.9	
105	5.5	4.9	4.2	6.6	5.7		6.2	5.3		5.1				4.9	
112	4.9	4.4	4.0	6.4	5.5	4.4	6.0	5.1		5.1	4.4			4.9	
118	4.6	4.2	3.7	6.2	5.3	4.2	5.7	4.9		5.1	4.4			4.6	
125	4.2	3.7	3.5	6.0	5.1	4.0	5.7	4.9		4.9	4.2			4.6	
131	3.7	3.5	3.3	5.7	4.9	4.0	5.5	4.6	4.0	4.9	4.2			4.6	
138	3.5	3.3	3.1	5.5	4.6	3.7	5.3	4.6	4.0	4.6	4.0			4.4	
144	3.3	3.1		5.3	4.4	3.5	5.3	4.4	3.7	4.6	4.0			4.4	
151	2.9	2.9		5.3	4.2	3.5	5.1	4.4	3.7	4.4	4.0			4.2	
158				4.9	4.0	3.3	5.1	4.2	3.5	4.4	3.7			4.2	
164				4.6	3.7	3.3	4.9	4.2	3.5	4.4	3.7			4.2	
171				4.4	3.5	3.1	4.6	4.0	3.3	4.2	3.7			4.0	
184				4.0	3.3	3.1	4.4	3.7	3.3	4.0	3.5			3.7	
197				3.5	3.1		4.4	3.5	3.1	3.7	3.3				
210				3.1	2.9		3.1	3.3	2.9		3.1				
223								3.1	2.9						

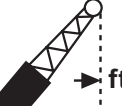
		 HYDRO	 27.2 ft	 360°	77,161 lbs	lbs x 1,000	SAE
---	---	---	---	--	-------------------	-------------	------------

 ft	43.4 ft + 3.7 ft + 35.8 ft			112.0 ft + 3.7 ft + 35.8 ft			166.9 ft + 3.7 ft + 35.8 ft			208.0 ft + 3.7 ft + 35.8 ft			223.1 ft + 3.7 ft + 35.8 ft		
	0°	20°	40°	0°	20°	40°	0°	20°	40°	0°	20°	40°	0°	20°	40°
9.8	43.4														
11.5	43.2														
13.1	42.1														
14.8	41.0														
16.4	39.7														
19.7	37.5	31.1		41.9											
23.0	35.3	29.1		40.6											
26.2	33.3	27.3		39.2											
29.5	31.5	25.6	21.4	38.1											
32.8	29.8	24.3	20.5	36.8	29.3		28.9								
36.1	28.4	23.1	19.6	35.7	28.4		28.9								
39.4	27.1	22.0	19.0	34.6	27.3		28.9								
45.9	24.3	20.1	17.9	32.4	25.6	20.3	28.7	23.8		16.5					
52.5	21.6	18.5	17.0	30.6	24.3	19.6	26.9	22.7		16.5			14.6		
59.1	19.4	17.4	16.3	28.9	22.9	19.0	25.6	21.6	19.2	16.5	16.1		14.6		
65.6	17.6	16.5		27.3	21.6	18.3	24.3	20.5	18.5	16.5	15.4		14.6	14.3	
72.2	16.3	15.9		26.0	20.7	17.9	23.1	19.6	17.9	15.9	14.8	13.7	14.6	13.7	12.8
78.7				24.9	19.8	17.4	22.0	18.7	17.2	15.2	14.1	13.2	14.1	13.2	12.3
85.3				23.8	19.0	17.0	21.2	18.1	16.5	14.8	13.4	12.8	13.4	12.6	11.9
91.9				20.5	18.3	16.5	20.1	17.4	16.1	14.3	13.0	12.3	13.2	12.1	11.5
98.4				17.4	17.6	16.3	19.2	16.8	15.7	13.7	12.6	11.9	12.8	11.7	11.0
105				14.8	16.3	16.1	16.8	16.1	15.2	13.2	12.1	11.5	12.1	11.2	10.8
112				12.3	13.9	15.2	14.3	15.7	14.8	12.8	11.7	11.2	11.7	11.0	10.4
118				10.4	11.7		12.3	13.9	14.3	12.3	11.5	10.8	11.5	10.6	10.1
125				8.6	9.7		10.6	12.1	13.4	11.9	11.0	10.6	11.0	10.4	9.7
131				7.1	7.9		9.0	10.4	11.5	10.8	10.8	10.1	10.4	9.9	9.5
138				5.7			7.5	8.8	9.9	9.3	10.6	9.9	9.0	9.7	9.3
144							6.2	7.3	8.4	7.9	9.0	9.7	7.7	8.8	9.0
151							5.1	6.0	7.1	6.8	7.7	8.6	6.6	7.7	8.4
158							4.0	4.9	5.7	5.7	6.6	7.3	5.3	6.4	7.3
164							3.1	3.7		4.6	5.5	6.2	4.4	5.3	6.2
171								2.9		3.7	4.6	5.1		4.4	5.1
184												3.3			

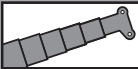
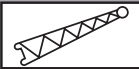
Lifting capacities / Capacidades de elevación









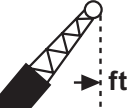

77,161 lbs

lbs x 1,000

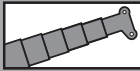
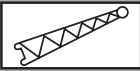

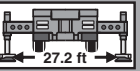

SAE

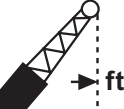
 ft	43.4 ft + 3.7 ft + 55.4 ft			112.0 ft + 3.7 ft + 55.4 ft			166.9 ft + 3.7 ft + 55.4 ft			208.0 ft + 3.7 ft + 55.4 ft			223.1 ft + 3.7 ft + 55.4 ft		
	0°	20°	40°	0°	20°	40°	0°	20°	40°	0°	20°	40°	0°	20°	40°
9.8	38.8														
11.5	38.1														
13.1	37.5														
14.8	36.8														
16.4	35.9														
19.7	34.2														
23.0	32.6				32.2										
26.2	31.1				32.2										
29.5	29.8	24.5			31.7										
32.8	28.2	22.9			30.9										
36.1	27.1	21.4			30.0		18.3								
39.4	25.6	20.1			29.3		18.3								
45.9	22.0	17.9	15.0		27.8	22.0	18.3								
52.5	19.2	16.1	13.7	26.5	20.7		18.3			12.3					
59.1	17.0	14.8	12.8	25.1	19.4	14.6	18.3	17.2		12.3			11.2		
65.6	15.2	13.4	11.9	24.0	18.3	13.9	18.3	16.3		12.3			11.2		
72.2	13.9	12.6	11.2	22.9	17.2	13.2	18.3	15.7		12.3	12.1		11.2		
78.7	12.6	11.7	10.6	21.2	16.1	12.8	17.9	15.0	13.2	12.3	11.5		11.2	10.8	
85.3	11.5	10.8		19.6	15.2	12.3	17.2	14.6	13.0	12.3	11.0		11.2	10.4	
91.9	10.6	10.4		18.3	14.3	11.9	16.5	13.9	12.6	11.9	10.8	9.9	11.0	10.1	9.3
98.4				17.0	13.7	11.5	15.9	13.4	12.1	11.5	10.4	9.5	10.6	9.7	9.0
105				15.9	13.0	11.2	15.2	13.0	11.9	11.0	9.9	9.3	10.1	9.3	8.6
112				14.1	12.6	10.8	14.6	12.6	11.5	10.8	9.7	9.0	10.1	9.0	8.4
118				12.1	11.9	10.6	13.7	12.3	11.2	10.4	9.3	8.6	9.7	8.8	8.2
125				10.4	11.5	10.4	11.7	11.9	11.0	10.1	9.0	8.4	9.3	8.4	7.9
131				8.6	10.6	10.1	10.1	11.7	10.8	9.7	8.8	8.2	9.0	8.2	7.7
138				7.3	8.8		8.6	10.6	10.4	9.5	8.4	7.9	8.8	7.9	7.5
144				6.0	7.3		7.3	9.0	10.1	8.4	8.2	7.7	7.9	7.7	7.3
151				4.9	6.0		6.2	7.7	8.8	7.1	7.9	7.7	6.8	7.5	7.1
158				4.0			5.1	6.6	7.5	6.0	7.5	7.5	5.7	7.3	6.8
164							4.2	5.5	6.2	5.1	6.4	7.3	4.9	6.2	6.6
171							3.3	4.4	5.1	4.2	5.5	6.4		5.3	6.4
184								2.4			3.7	4.4			



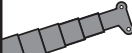

					77,161 lbs	lbs x 1,000	SAE
---	---	---	---	---	-------------------	-------------	------------

 ft	43.4 ft + 3.7 ft + 75.1 ft			112.0 ft + 3.7 ft + 75.1 ft			166.9 ft + 3.7 ft + 75.1 ft			208.0 ft + 3.7 ft + 75.1 ft			223.1 ft + 3.7 ft + 75.1 ft		
	0°	20°	40°	0°	20°	40°	0°	20°	40°	0°	20°	40°	0°	20°	40°
11.5	24.5														
13.1	24.5														
14.8	24.5														
16.4	24.0														
19.7	23.1														
23.0	22.3														
26.2	21.4			19.6											
29.5	20.5			19.6											
32.8	19.6			19.6											
36.1	19.0			19.6											
39.4	18.1	16.8		19.6											
45.9	16.8	15.0		19.0			13.2								
52.5	15.4	13.4		18.1			13.2								
59.1	14.1	12.1		17.2	14.3		13.2								
65.6	12.6	11.0	9.5	16.3	13.4		13.2			9.5			8.8		
72.2	11.2	10.1	8.8	15.7	13.0		13.2	12.1		9.5			8.8		
78.7	10.4	9.3	8.4	15.0	12.1	9.3	13.2	11.7		9.5			8.8		
85.3	9.5	8.6	7.7	14.3	11.5	9.0	13.2	11.5		9.5	9.3		8.8		
91.9	8.6	7.9	7.5	13.7	10.8	8.6	13.0	11.0	8.8	9.5	8.8		8.8	8.4	
98.4	8.2	7.5	7.1	13.0	10.4	8.4	12.6	10.6	8.6	9.5	8.6		8.8	7.9	
105	7.5	7.1		12.6	9.7	7.9	12.3	10.4	8.4	9.5	8.2	7.5	8.6	7.7	
112	7.1	6.6		11.9	9.3	7.7	11.9	10.1	8.2	9.0	7.9	7.3	8.4	7.5	6.8
118				11.2	8.8	7.5	11.7	9.9	7.9	8.6	7.7	7.1	7.9	7.3	6.6
125				10.6	8.6	7.3	11.2	9.5	7.7	8.4	7.5	6.8	7.7	7.1	6.4
131				9.9	8.2	7.1	10.8	9.3	7.7	8.2	7.1	6.6	7.5	6.8	6.2
138				8.8	7.9	7.1	9.3	9.0	7.5	7.9	6.8	6.4	7.3	6.6	6.2
144				7.5	7.5	6.8	7.9	8.6	7.3	7.5	6.6	6.2	7.1	6.4	6.0
151				6.2	7.3	6.6	6.8	8.4	7.1	7.3	6.6	6.2	6.8	6.2	5.7
158				5.1	6.6		5.7	7.7	7.1	6.4	6.4	6.0	6.0	6.0	5.5
164				4.2	5.3		4.6	6.6	6.8	5.3	6.2	5.7		5.7	5.5
171				3.3	4.2		3.7	5.5	6.6	4.4	6.0	5.7		5.5	5.3
184								3.5	4.6		4.4	5.3			5.1

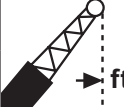
Lifting capacities / Capacidades de elevación

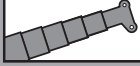
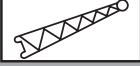
		 HYDRO	 27.2 ft	 360°	77,161 lbs	lbs x 1,000	SAE
---	---	--	--	---	-------------------	-------------	------------

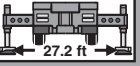
 ft	43.4 ft + 3.7 ft + 94.8 ft			112.0 ft + 3.7 ft + 94.8 ft			166.9 ft + 3.7 ft + 94.8 ft			208.0 ft + 3.7 ft + 94.8 ft			223.1 ft + 3.7 ft + 94.8 ft		
	0°	20°	40°	0°	20°	40°	0°	20°	40°	0°	20°	40°	0°	20°	40°
16.4	14.3														
19.7	14.3														
23.0	14.3														
26.2	14.3														
29.5	14.3			13.7											
32.8	14.3			13.7											
36.1	14.1			13.7											
39.4	13.7			13.7											
45.9	12.8			13.4											
52.5	11.9	10.8		12.8			9.7								
59.1	11.0	9.9		12.3			9.7								
65.6	10.4	9.3		11.9	9.9		9.7			7.3			6.8		
72.2	9.7	8.6		11.5	9.5		9.7			7.3			6.8		
78.7	9.0	7.9	6.8	10.8	9.0		9.7	8.6		7.3			6.8		
85.3	8.4	7.3	6.4	10.4	8.6		9.5	8.2		7.3			6.8		
91.9	7.5	6.6	6.0	9.9	8.4	6.6	9.3	7.9		7.3			6.8		
98.4	6.8	6.2	5.5	9.5	7.9	6.4	9.0	7.7		7.3	6.8		6.8		
105	6.4	5.7	5.3	9.3	7.7	6.2	8.8	7.5		7.3	6.6		6.8	6.4	
112	5.7	5.3	5.1	8.8	7.3	5.7	8.6	7.3	6.0	7.3	6.6		6.8	6.2	
118	5.3	5.1	4.9	8.6	6.8	5.5	8.4	7.1	6.0	7.3	6.4		6.8	6.0	
125	5.1	4.9		8.2	6.6	5.5	8.2	6.8	5.7	7.1	6.2	5.5	6.6	5.7	
131	4.6	4.4		7.9	6.2	5.3	7.9	6.6	5.5	6.8	6.0	5.3	6.4	5.5	5.1
138				7.3	6.0	5.1	7.7	6.4	5.3	6.6	5.7	5.3	6.2	5.3	4.9
144				6.8	5.7	4.9	7.5	6.4	5.3	6.4	5.5	5.1	6.0	5.3	4.9
151				6.6	5.5	4.9	7.3	6.2	5.1	6.2	5.3	4.9	5.5	5.1	4.6
158				6.0	5.3	4.6	6.2	6.0	5.1	6.0	5.1	4.9	5.3	4.9	4.4
164				5.1	5.1	4.6	5.1	6.0	4.9	5.5	5.1	4.6		4.6	4.4
171				4.2	4.9	4.4	4.2	5.7	4.9		4.9	4.4		4.4	4.2
184				2.4	3.7			4.4	4.6		4.6	4.2			4.0
197									4.0						

		 HYDRO	 27.2 ft	 360°	77,161 lbs	lbs x 1,000	SAE
---	---	---	---	--	-------------------	-------------	------------

 ft	43.4 ft + 3.7 ft + 114.5 ft			112.0 ft + 3.7 ft + 114.5 ft			167.0 ft + 3.7 ft + 114.5 ft			208.0 ft + 3.7 ft + 114.5 ft			223.1 ft + 3.7 ft + 114.5 ft		
	0°	20°	40°	0°	20°	40°	0°	20°	40°	0°	20°	40°	0°	20°	40°
19.7	10.4														
23.0	10.4														
26.2	10.4														
29.5	10.4														
32.8	10.4														
36.1	10.4			9.9											
39.4	9.9			9.9											
45.9	9.5			9.5											
52.5	8.8			9.3											
59.1	8.4			8.8											
65.6	7.9	7.3		8.4			7.3			5.7			5.3		
72.2	7.5	6.8		8.2			7.1			5.7			5.3		
78.7	7.1	6.4		7.7	6.6		6.8			5.5			5.3		
85.3	6.6	6.0		7.5	6.4		6.6			5.5			5.1		
91.9	6.2	5.7		7.3	6.2		6.4	5.5		5.3			5.1		
98.4	6.0	5.3	4.6	6.8	6.0		6.4	5.3		5.3			4.9		
105	5.5	4.9	4.2	6.6	5.7		6.2	5.3		5.1			4.9		
112	4.9	4.4	4.0	6.4	5.5	4.4	6.0	5.1		5.1	4.4		4.9		
118	4.6	4.2	3.7	6.2	5.3	4.2	5.7	4.9		5.1	4.4		4.6		
125	4.2	3.7	3.5	6.0	5.1	4.0	5.7	4.9		4.9	4.2		4.6		
131	3.7	3.5	3.3	5.7	4.9	4.0	5.5	4.6	4.0	4.9	4.2		4.6		
138	3.5	3.3	3.1	5.5	4.6	3.7	5.3	4.6	4.0	4.6	4.0		4.4		
144	3.3	3.1		5.3	4.4	3.5	5.3	4.4	3.7	4.6	4.0		4.4		
151	2.9	2.9		5.3	4.2	3.5	5.1	4.4	3.7	4.4	4.0		4.2		
158				4.9	4.0	3.3	5.1	4.2	3.5	4.4	3.7				
164				4.6	3.7	3.3	4.9	4.2	3.5	4.4	3.7				
171				4.4	3.5	3.1	4.4	4.0	3.3		3.7				
184				3.1	3.3	3.1		3.7	3.3		3.5				
197					3.1				3.1						

Lifting capacities / Capacidades de elevación

		 HYDRO	 27.2 ft	 360°	51,808 lbs	lbs x 1,000	SAE
---	---	---	---	--	-------------------	-------------	------------

 ft	43.4 ft + 3.7 ft + 35.8 ft			112.0 ft + 3.7 ft + 35.8 ft			167.0 ft + 3.7 ft + 35.8 ft			208.0 ft + 3.7 ft + 35.8 ft			223.1 ft + 3.7 ft + 35.8 ft		
	0°	20°	40°	0°	20°	40°	0°	20°	40°	0°	20°	40°	0°	20°	40°
9.8	43.4														
11.5	43.2														
13.1	42.1														
14.8	41.0														
16.4	39.7														
19.7	37.5	31.1		41.9											
23.0	35.3	29.1		40.6											
26.2	33.3	27.3		39.2											
29.5	31.5	25.6	21.4	38.1											
32.8	29.8	24.3	20.5	36.8	29.3		28.9								
36.1	28.4	23.1	19.6	35.7	28.4		28.9								
39.4	27.1	22.0	19.0	34.6	27.3		28.9								
45.9	24.3	20.1	17.9	32.4	25.6	20.3	28.7	23.8		16.5					
52.5	21.6	18.5	17.0	30.6	24.3	19.6	26.9	22.7		16.5			14.6		
59.1	19.4	17.4	16.3	28.9	22.9	19.0	25.6	21.6	19.2	16.5	16.1		14.6		
65.6	17.6	16.5		27.3	21.6	18.3	24.3	20.5	18.5	16.5	15.4		14.6	14.3	
72.2	16.3	15.9		24.9	20.7	17.9	23.1	19.6	17.9	15.9	14.8	13.7	14.6	13.7	12.8
78.7				20.3	19.8	17.4	22.0	18.7	17.2	15.2	14.1	13.2	14.1	13.2	12.3
85.3				16.5	19.0	17.0	18.7	18.1	16.5	14.8	13.4	12.8	13.4	12.6	11.9
91.9				13.4	15.7	16.5	15.7	17.4	16.1	14.3	13.0	12.3	13.2	12.1	11.5
98.4				10.8	12.8	14.6	13.0	15.0	15.7	13.7	12.6	11.9	12.8	11.7	11.0
105				8.6	10.4	11.9	10.6	12.6	14.6	12.6	12.1	11.5	12.1	11.2	10.8
112				6.6	8.2	9.3	8.6	10.4	12.1	10.6	11.7	11.2	10.4	11.0	10.4
118				4.9	6.2		7.1	8.6	10.1	8.8	10.4	10.8	8.6	10.1	10.1
125				3.5	4.4		5.5	6.8	8.4	7.3	8.8	9.9	7.1	8.6	9.7
131					2.9		4.2	5.3	6.6	6.0	7.3	8.2		7.1	8.2
138								4.2	5.3		6.0	6.8			6.6
144									4.0			5.5			

		 HYDRO	 27.2 ft	 360°	51,808 lbs	lbs x 1,000	SAE
---	---	---	---	--	-------------------	-------------	------------

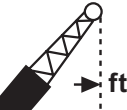
 ft	43.4 ft + 3.7 ft + 55.4 ft			112.0 ft + 3.7 ft + 55.4 ft			166.9 ft + 3.7 ft + 55.4 ft			208.0 ft + 3.7 ft + 55.4 ft			223.1 ft + 3.7 ft + 55.4 ft		
	0°	20°	40°	0°	20°	40°	0°	20°	40°	0°	20°	40°	0°	20°	40°
9.8	38.8														
11.5	38.1														
13.1	37.5														
14.8	36.8														
16.4	35.9														
19.7	34.2														
23.0	32.6				32.2										
26.2	31.1				32.2										
29.5	29.8	24.5			31.7										
32.8	28.2	22.9			30.9										
36.1	27.1	21.4			30.0			18.3							
39.4	25.6	20.1			29.3			18.3							
45.9	22.0	17.9	15.0		27.8	22.0		18.3							
52.5	19.2	16.1	13.7	26.5	20.7			18.3			12.3				
59.1	17.0	14.8	12.8	25.1	19.4	14.6	18.3	17.2		12.3				11.2	
65.6	15.2	13.4	11.9	24.0	18.3	13.9	18.3	16.3		12.3				11.2	
72.2	13.9	12.6	11.2	22.9	17.2	13.2	18.3	15.7		12.3	12.1			11.2	
78.7	12.6	11.7	10.6	21.2	16.1	12.8	17.9	15.0	13.2	12.3	11.5			11.2	10.8
85.3	11.5	10.8		18.3	15.2	12.3	17.2	14.6	13.0	12.3	11.0			11.2	10.4
91.9	10.6	10.4		15.2	14.3	11.9	16.5	13.9	12.6	11.9	10.8	9.9		11.0	10.1
98.4				12.6	13.7	11.5	14.3	13.4	12.1	11.5	10.4	9.5		10.6	9.7
105				10.4	13.0	11.2	11.9	13.0	11.9	11.0	9.9	9.3		10.1	9.3
112				8.4	11.0	10.8	9.9	12.6	11.5	10.8	9.7	9.0		10.1	9.0
118				6.6	9.0	10.6	8.2	10.6	11.2	9.3	9.3	8.6		8.8	8.8
125				5.1	7.3	8.6	6.6	8.8	10.6	7.7	9.0	8.4		7.3	8.4
131				3.7	5.7	6.8	5.3	7.3	8.8	6.2	8.4	8.2			8.2
138				2.6	4.2			6.0	7.3		7.1	7.9			7.5
144					2.9			4.6	6.0		5.7	7.1			7.1
151									4.6			6.0			

Lifting capacities / Capacidades de elevación













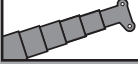
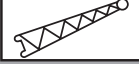

51,808 lbs

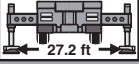
lbs x 1,000



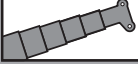
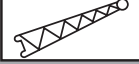

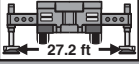
SAE

ft	43.4 ft + 3.7 ft + 75.1 ft			112.0 ft + 3.7 ft + 75.1 ft			166.9 ft + 3.7 ft + 75.1 ft			208.0 ft + 3.7 ft + 75.1 ft			223.1 ft + 3.7 ft + 75.1 ft		
	0°	20°	40°	0°	20°	40°	0°	20°	40°	0°	20°	40°	0°	20°	40°
11.5	24.5														
13.1	24.5														
14.8	24.5														
16.4	24.0														
19.7	23.1														
23.0	22.3														
26.2	21.4			19.6											
29.5	20.5			19.6											
32.8	19.6			19.6											
36.1	19.0			19.6											
39.4	18.1	16.8		19.6											
45.9	16.8	15.0		19.0			13.2								
52.5	15.4	13.4		18.1			13.2								
59.1	14.1	12.1		17.2	14.3		13.2								
65.6	12.6	11.0	9.5	16.3	13.4		13.2			9.5			8.8		
72.2	11.2	10.1	8.8	15.7	13.0		13.2	12.1		9.5			8.8		
78.7	10.4	9.3	8.4	15.0	12.1	9.3	13.2	11.7		9.5			8.8		
85.3	9.5	8.6	7.7	14.3	11.5	9.0	13.2	11.5		9.5	9.3		8.8		
91.9	8.6	7.9	7.5	13.7	10.8	8.6	13.0	11.0	8.8	9.5	8.8		8.8	8.4	
98.4	8.2	7.5	7.1	13.0	10.4	8.4	12.6	10.6	8.6	9.5	8.6		8.8	7.9	
105	7.5	7.1		12.1	9.7	7.9	12.3	10.4	8.4	9.5	8.2	7.5	8.6	7.7	
112	7.1	6.6		9.9	9.3	7.7	10.6	10.1	8.2	9.0	7.9	7.3	8.4	7.5	6.8
118				8.2	8.8	7.5	8.8	9.9	7.9	8.6	7.7	7.1	7.9	7.3	6.6
125				6.6	8.6	7.3	7.3	9.5	7.7	7.9	7.5	6.8	7.5	7.1	6.4
131				5.3	7.7	7.1	6.0	8.6	7.7	6.6	7.1	6.6		6.8	6.2
138				4.2	6.2	7.1		7.3	7.5		6.8	6.4		6.6	6.2
144				3.1	4.9	6.4		6.0	7.3		6.6	6.2			6.0
151					3.7	4.9		4.9	6.4			6.2			5.7
158					2.6				5.3			6.0			

     51,808 lbs lbs x 1,000 <div style="float: right; border: 1px solid black; padding: 2px;">SAE</div>															
ft	43.4 ft + 3.7 ft + 94.8 ft			112.0 ft + 3.7 ft + 94.8 ft			166.9 ft + 3.7 ft + 94.8 ft			208.0 ft + 3.7 ft + 94.8 ft			223.1 ft + 3.7 ft + 94.8 ft		
	0°	20°	40°	0°	20°	40°	0°	20°	40°	0°	20°	40°	0°	20°	40°
16.4	14.3														
19.7	14.3														
23.0	14.3														
26.2	14.3														
29.5	14.3			13.7											
32.8	14.3			13.7											
36.1	14.1			13.7											
39.4	13.7			13.7											
45.9	12.8			13.4											
52.5	11.9	10.8		12.8			9.7								
59.1	11.0	9.9		12.3			9.7								
65.6	10.4	9.3		11.9	9.9		9.7			7.3			6.8		
72.2	9.7	8.6		11.5	9.5		9.7			7.3			6.8		
78.7	9.0	7.9	6.8	10.8	9.0		9.7	8.6		7.3			6.8		
85.3	8.4	7.3	6.4	10.4	8.6		9.5	8.2		7.3			6.8		
91.9	7.5	6.6	6.0	9.9	8.4	6.6	9.3	7.9		7.3			6.8		
98.4	6.8	6.2	5.5	9.5	7.9	6.4	9.0	7.7		7.3	6.8		6.8		
105	6.4	5.7	5.3	9.3	7.7	6.2	8.8	7.5		7.3	6.6		6.8	6.4	
112	5.7	5.3	5.1	8.8	7.3	5.7	8.6	7.3	6.0	7.3	6.6		6.8	6.2	
118	5.3	5.1	4.9	8.6	6.8	5.5	8.4	7.1	6.0	7.3	6.4		6.8	6.0	
125	5.1	4.9		7.7	6.6	5.5	7.7	6.8	5.7	7.1	6.2	5.5		5.7	
131	4.6	4.4		6.2	6.2	5.3	6.4	6.6	5.5		6.0	5.3		5.5	5.1
138				5.1	6.0	5.1		6.4	5.3		5.7	5.3		5.3	4.9
144				4.0	5.7	4.9		6.4	5.3		5.5	5.1			4.9
151					5.3	4.9		5.7	5.1			4.9			4.6
158					4.2	4.6			5.1			4.9			
164					3.1	4.4			4.9						
171						3.3									

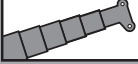
     51,808 lbs lbs x 1,000 <div style="float: right; border: 1px solid black; padding: 2px;">SAE</div>															
ft	43.4 ft + 3.7 ft + 114.5 ft			112.0 ft + 3.7 ft + 114.5 ft			166.9 ft + 3.7 ft + 114.5 ft			208.0 ft + 3.7 ft + 114.5 ft			223.1 ft + 3.7 ft + 114.5 ft		
	0°	20°	40°	0°	20°	40°	0°	20°	40°	0°	20°	40°	0°	20°	40°
19.7	10.4														
23.0	10.4														
26.2	10.4														
29.5	10.4														
32.8	10.4														
36.1	10.4			9.9											
39.4	9.9			9.9											
45.9	9.5			9.5											
52.5	8.8			9.3											
59.1	8.4			8.8											
65.6	7.9	7.3		8.4			7.3			5.7			5.3		
72.2	7.5	6.8		8.2			7.1			5.7			5.3		
78.7	7.1	6.4		7.7	6.6		6.8			5.5			5.3		
85.3	6.6	6.0		7.5	6.4		6.6			5.5			5.1		
91.9	6.2	5.7		7.3	6.2		6.4	5.5		5.3			5.1		
98.4	6.0	5.3	4.6	6.8	6.0		6.4	5.3		5.3			4.9		
105	5.5	4.9	4.2	6.6	5.7		6.2	5.3		5.1			4.9		
112	4.9	4.4	4.0	6.4	5.5	4.4	6.0	5.1		5.1	4.4		4.9		
118	4.6	4.2	3.7	6.2	5.3	4.2	5.7	4.9		5.1	4.4		4.6		
125	4.2	3.7	3.5	6.0	5.1	4.0	5.7	4.9		4.9	4.2				
131	3.7	3.5	3.3	5.7	4.9	4.0	5.5	4.6	4.0		4.2				
138	3.5	3.3	3.1	5.5	4.6	3.7		4.6	4.0		4.0				
144	3.3	3.1		4.6	4.4	3.5		4.4	3.7		4.0				
151	2.9	2.9		3.5	4.2	3.5		4.4	3.7						
158					4.0	3.3			3.5						
164					3.7	3.3			3.5						
171						3.1			3.3						

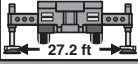
Lifting heights / Alturas de elevación

				156,527 lbs	lbs x 1,000	SAE
---	---	---	---	--------------------	-------------	------------

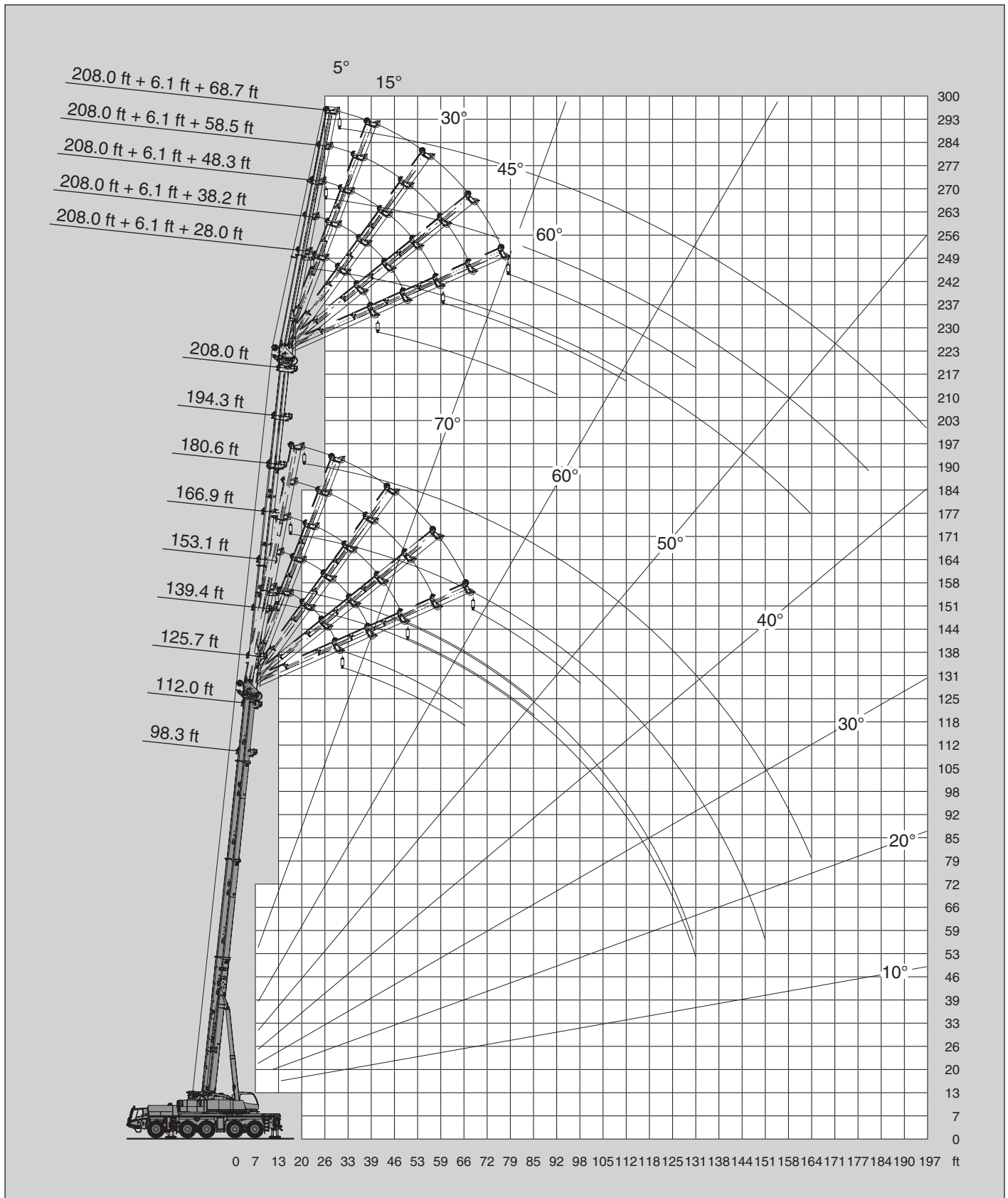

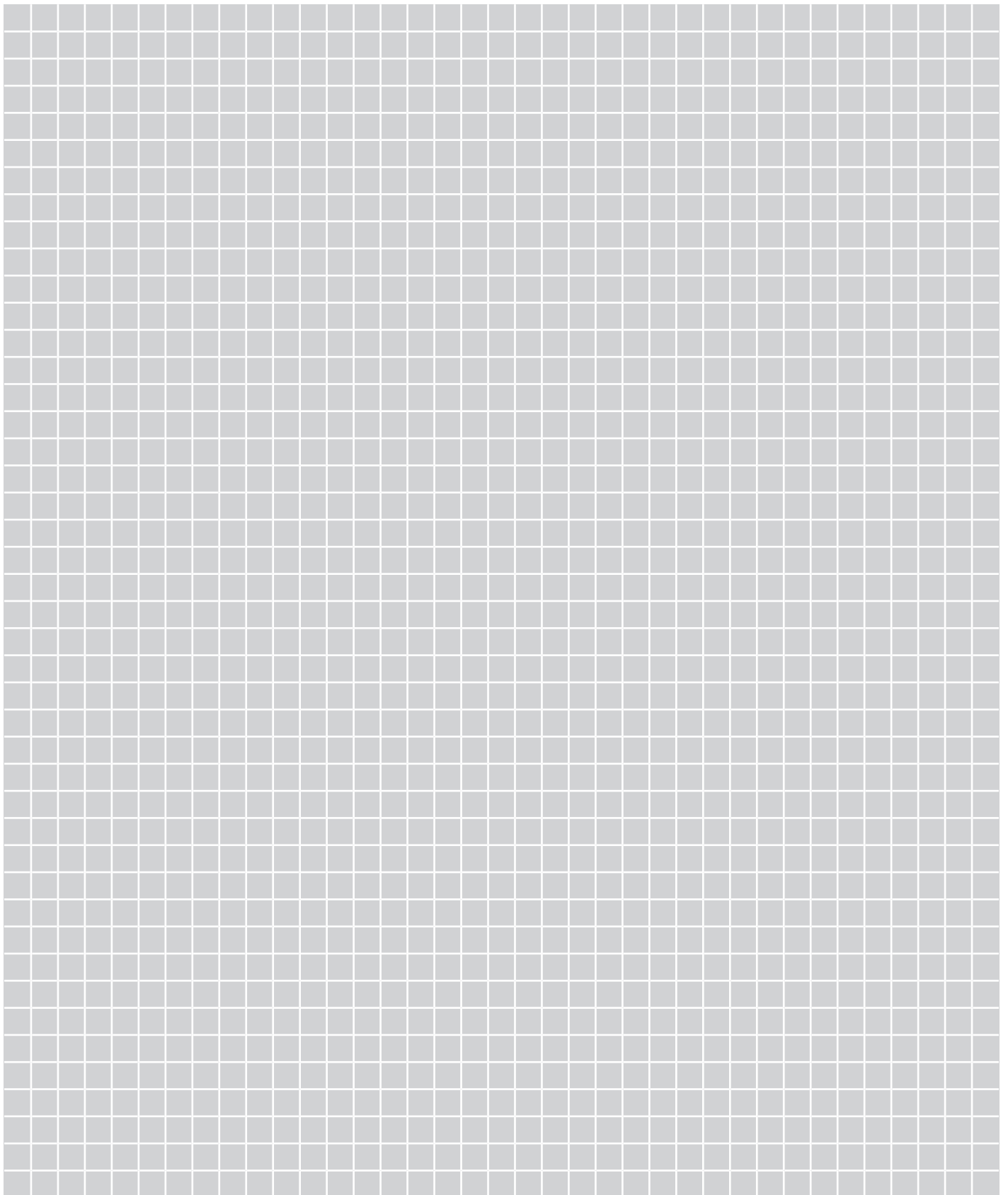

Axle weight distribution chart / Distribución de pesos por ejes

	Axle Eje	1	2	3	4	5	Total weight Peso total
	Tires 525/80 R 25 (20.50 R 25) [lbs]		23,914	23,906	29,483	29,375	29,390

Boom to front	Total [lbs]	Axle 1 [lbs]	Axle 2 [lbs]	Axle 3 [lbs]	Axle 4 [lbs]	Axle 5 [lbs]
Base machine with equipment for USA, 16.00 R 25 tires, no counterweight, no fuel, no driver	128,466	24,796	24,783	26,303	26,294	26,289
* Fuel in carrier	1,138	-259	-257	561	544	548
* Fuel in superstructure	468	-73	-73	209	202	204
* Driver in carrier	198	168	167	-46	-45	-45
* 11.0 ton [10.0 t]** headache ball (in transport position)	744	683	678	-210	-203	-204
35.3 ton [32.0 t]** (1 sheave) hook block (in transport position)	1,065	1,010	1,004	-322	-312	-314
17.7 ft / 43.3 ft Mechanical offset boom extension	3,101	1,811	1,799	-173	-167	-168
* 17.7 ft / 43.3 ft Hydraulic offset boom extension	3,420	2,069	2,055	-239	-232	-233
* Auxiliary winch with cable	3,722	-1,704	-1,693	2,418	2,343	2,358
* Auxiliary boom point sheave (single top)	139	139	138	-47	-45	-46
* 2 nd oil cooler	104	-10	-10	42	41	41
* Boom dismounting device	471	-10	-10	167	162	163
Drive 10 x 6	-831	-732	-160	0	0	0
* 20.50 R 25 tires in lieu of 16.00 R 25 tires	1,442	288	288	289	289	289
Eddy-current brake	985	144	143	237	230	231
* Towing attachment	30	-12	-12	18	18	18
* Tool box at rear	197	-86	-85	125	121	122

* Basic configuration, marked items are included

Counterweight on the carrier:						
Counterweight 7: 4,409 lbs [2.0 t]**	4,407	1,494	1,485	485	470	473
Counterweight 6: 22,046 lbs [10.0 t]**	21,739	7,428	7,380	2,354	2,281	2,296
Counterweight 5: 25,353 lbs [11.5 t]**	25,582	8,638	8,583	2,840	2,752	2,770
Counterweight 4: 25,353 lbs [11.5 t]**	25,467	8,685	8,629	2,769	2,684	2,701

** Metric

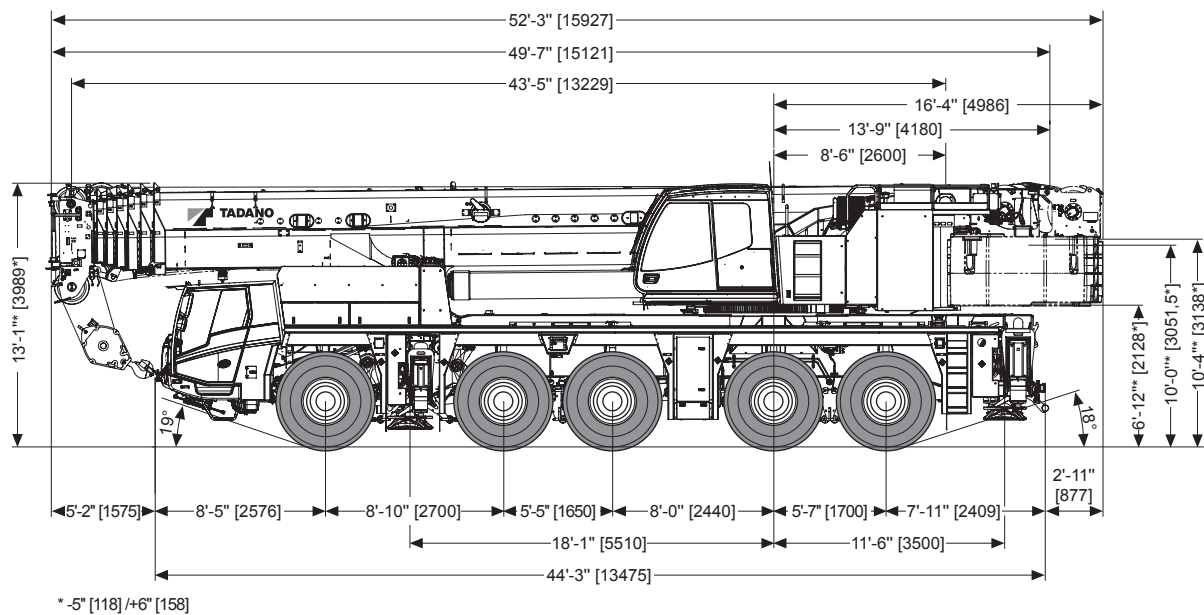

Axle weight distribution chart / Distribución de pesos por ejes

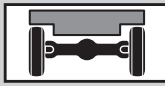

	Axle Eje	1	2	3	4	5	Dolly	Total weight Peso total
	Tires 525/80 R 25 (20.50 R 25) [lbs]	20,171	20,188	22,182	22,300	22,269	28,215	135,325*

Boom to front	Total [lbs]	Axle 1 [lbs]	Axle 2 [lbs]	Axle 3 [lbs]	Axle 4 [lbs]	Axle 5 [lbs]	Dolly [lbs]
Base machine with equipment for USA, 16.00 R 25 tires, no counterweight, no fuel, no driver	128,466	18,722	18,748	21,049	21,202	21,164	27,581
* Fuel in carrier	1,138	-259	-257	561	544	548	0
* Fuel in superstructure	468	49	49	126	122	123	0
* Driver in carrier	198	168	167	-46	-45	-45	0
* 11.0 ton [10.0 t]** headache ball (hanging at boom head)	744	-35	-35	-29	-28	-28	899
35.3 ton [32.0 t]** (1 sheave) hook block (boom head)	1,065	-47	-47	-39	-38	-38	1,274
88.1 ton [80.0 t]** (3 sheaves) hook block (boom head)	1,871	-91	-90	-75	-72	-73	2,271
17.7 ft / 43.3 ft Mechanical offset boom extension	3,101	129	128	107	103	104	2,530
* 17.7 ft / 43.3 ft Hydraulic offset boom extension	3,420	127	126	105	102	102	2,859
* Auxiliary winch with cable	3,722	1,520	1,510	235	228	229	0
* Auxiliary boom point sheave (single top)	139	-7	-6	-5	-5	-5	168
* 2 nd oil cooler	104	5	5	32	31	32	0
* Boom dismounting device	471	81	80	67	64	65	114
Drive 10 x 6	-891	-732	-160	0	0	0	0
* 20.50 R 25 tires in lieu of 16.00 R 25 tires	1,442	288	288	289	289	289	0
Eddy-current brake	985	144	143	237	230	231	0
* Towing attachment	30	-12	-12	18	18	18	0
* Tool box at rear	197	-86	-85	125	121	122	0

* Basic configuration, marked items are included

Counterweight on the carrier:							
Counterweight 7: 4,409 lbs [2.0 t]**	4,407	1,494	1,485	485	470	473	0
Counterweight 6: 22,046 lbs [10.0 t]**	21,739	7,428	7,380	2,354	2,281	2,296	0
Counterweight 5: 25,353 lbs [11.5 t]**	25,582	8,638	8,583	2,840	2,752	2,770	0
Counterweight 4: 25,353 lbs [11.5 t]**	25,467	8,685	8,629	2,769	2,684	2,701	0

** Metric

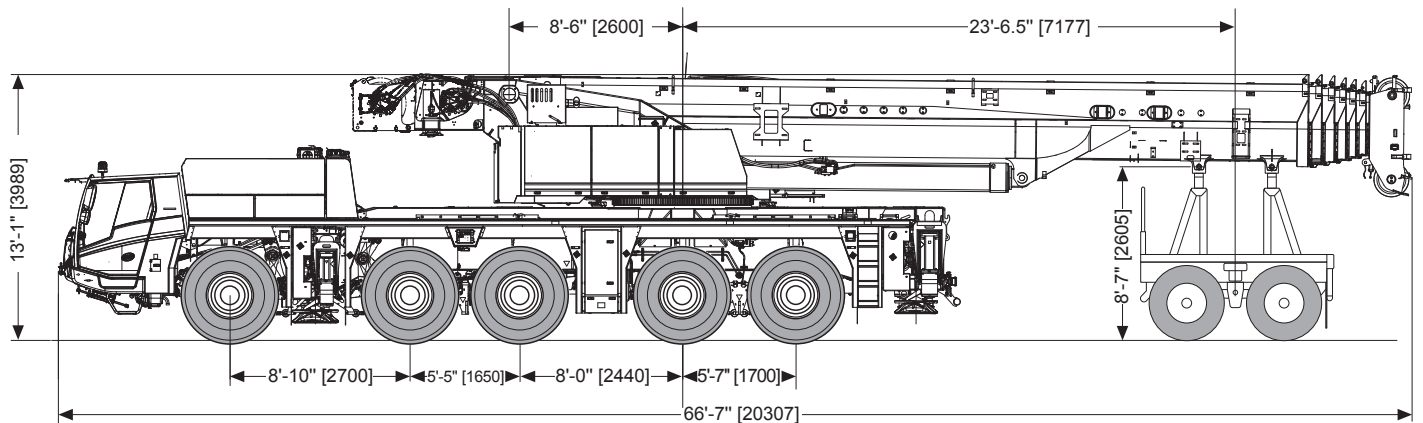

Counterweight versions / Variaciones de contrapeso

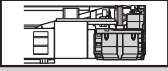
	Counterweight / Contrapeso	①	②	③	④	⑤	⑥	⑦
		[lbs]	26,455	26,455	26,455	25,353	25,353	22,046

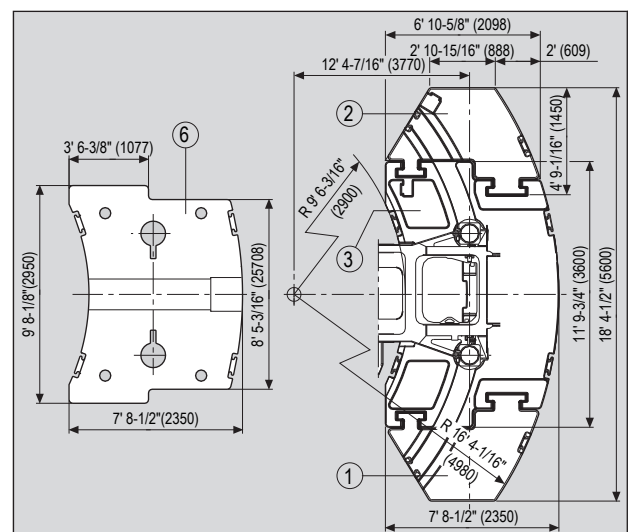
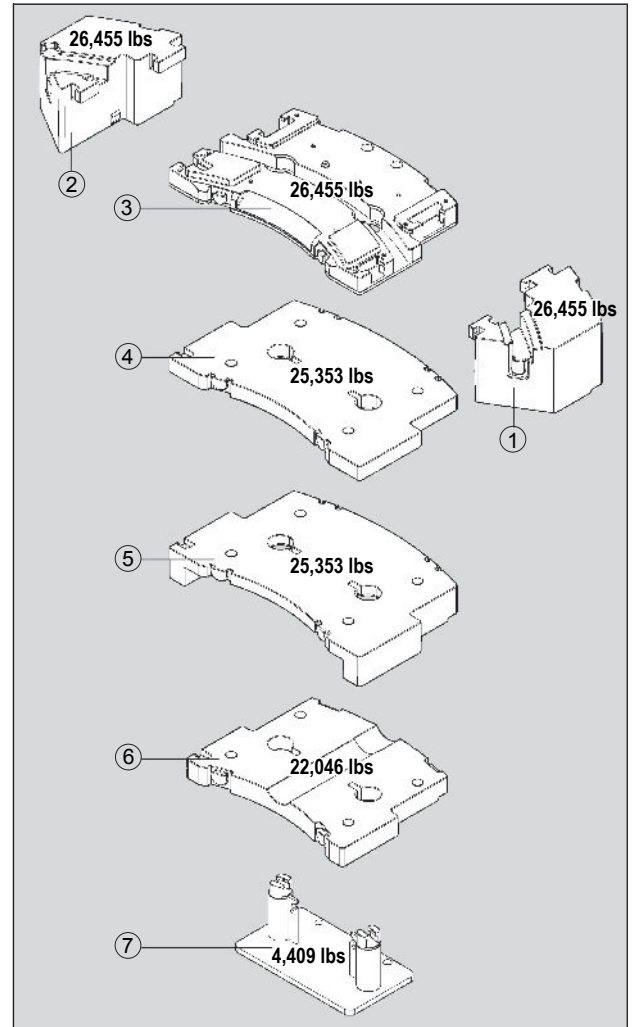
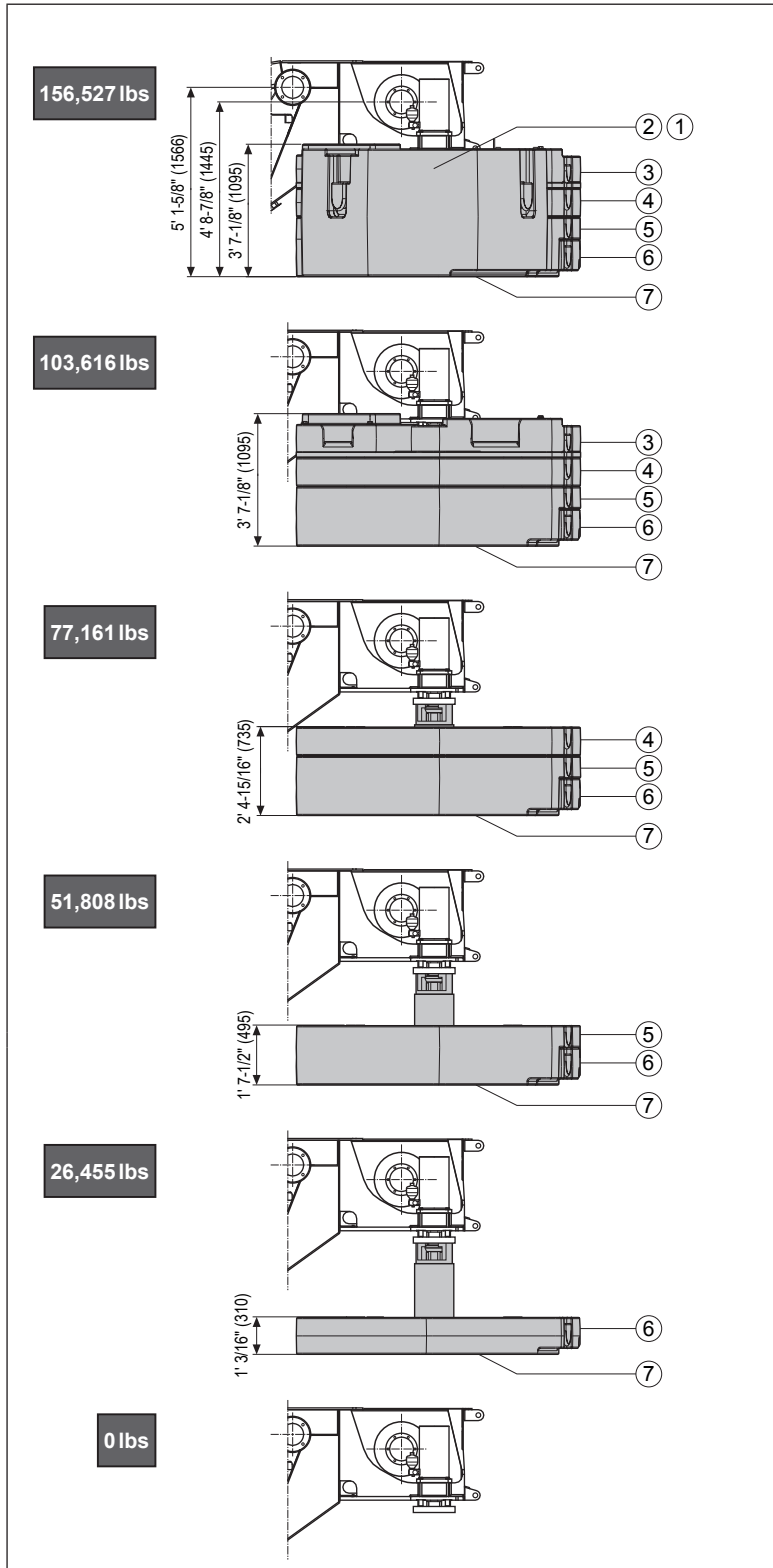



Frame Torsion-resistant, welded construction made from high strength, fine grained steel. Central lubricating system.

Outriggers 4 point, telescopic hydraulic outriggers, incl. automatic length detection and controls on both sides of carrier and in superstructure cab. Outrigger base 27'-2.75" (8.3 m) {18'-4.25" (5.6 m) mid extension} x 29'-6.75" (9.01 m).

Carrier engine Mercedes-Benz 6 cylinder model OM 471 LA (EPA Tier 4f), water-cooled diesel engine. Rated at 530 HP (390 kW) at 1,700 rpm. Torque 1,814 ft-lbs (2,460 Nm / 251 kpm) at 1,300 rpm. Engine rating according to ECE R 120. Fuel tank 159 gal (600 l). DEF Tank 11 gal (40 l).

Transmission ZF-AS-Tronic 12 AS 2531 mechanical transmission with electro-pneumatically operated dry-type clutch and automatic gear shifting with 12 forward gears and 2 reverse gears.

Transfer Case Two stage.

Drive 10 x 8 (10 x 6 optional*)

Axles

- 1st axle: steered, driven (*not driven), with differential lock, transverse.
- 2nd axle: steered, driven, shiftable, with differential lock, transverse.
- 3rd axle: steered, not driven.
- 4th axle: steered, driven, with differential lock, longitudinal and transverse.
- 5th axle: steered, driven, with differential lock, transverse.

Suspension Hydro-pneumatic with levelling adjustment.

Brake system Service disc brakes: dual circuit compressed air system with electronic wear indicator. Parking brake: spring loaded type acting on 2nd, 4th and 5th axle. Auxiliary brakes: Intarder and engine brake.

Tires (10) 445/95 R 25 (16.00 R 25), width 9'-10.13" (3.00 m).
(10) 525/80 R 25 (20.50 R 25), width 10'-6" (3.20 m).

Steering system ZF-Servocom, dual circuit hydraulic steering with emergency steering pump, mechanical hydraulically-assisted steering of front two axles and automatic steering of the 3rd and 4th axle up to a travel speed of 15.5 mph (25 km/h) and of the 5th axle up to 31.1 mph (50 km/h).

Carrier cab Two-man full width cab of composite (steel sheet metal and fibre-glass) structure, with safety glass, central locking system, air-cushioned seats, driver's seat offering various adjustment options, with memory function and heater, engine dependent water heater, air conditioning, Bluetooth hands-free equipment, multifunction display, rear view camera, radio/CD-player with USB port, control and operating elements for driving operation, Cruise Control and hill braking feature functions.

Electrical system 24 V DC, 2 batteries, outrigger area lighting, acoustic back-up alarm, lighting system with Bi halogen headlights; LED, daytime running light; LED, foglights, CAN bus system.

Optional Equipment (at extra charge)

Towing attachment, engine independent additional heater with engine pre-heat, ABS system, 525 / 80 R 25 (20.50 R 25) tires, spare wheel and tire, special painting and lettering.

Further optional equipment available upon request.

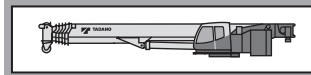

Frame Torsion-resistant, all-welded structure of high strength steel. Connected to carrier by single-row, ball bearing slewing ring with external gearing for 360° continuous rotation. Central lubricating system.

Superstructure engine Mercedes-Benz 4 cylinder model OM 934 LA (EPA Tier 4f), water-cooled diesel engine. Rated at 197 HP (145 kW) at 1,800 rpm. Torque 590 ft-lbs (800 Nm / 82 kpm) at 1,200 - 1,600 rpm. Engine rating according to ECE R 120. Fuel tank 66 gal (250 l). DEF Tank 2 gal (8 l).

Hydraulic system Three circuit diesel hydraulic system, 1 power-controlled axial piston twin pump (hydraulically adjustable) with accumulative power control and 1 axial piston pump, oil cooler.

Controls Electrical, 2 joy-stick levers for simultaneous operation of crane motions.

Telescopic boom 7 sections, made of high tensile, fine-grained steel, consisting of 1 base section and 6 telescoping sections extended by means of a single telescopic cylinder. All telescope sections extendable under partial load. 43.4 ft (13.2 m) to 223.1 ft (68.0 m) long. Boom head with 7 sheaves

Derricking system 1 double acting hydraulic cylinder with integral brake and holding valve.

Main winch Axial piston motor, winch drum with integrated planetary reduction and hydraulically controlled spring loaded, multiple disc brake and integrated free rotation (no sagging of load when hoisting). Hoist cable with 'Super-Stop' easy reeving system.

Slewing system Axial piston constant motor with three-stage planetary gear with service and parking brake. Open hydraulic circuit with wearless, dynamic free slewing function. Speed infinitely variable from 0 to 1.2 rpm.

Counterweight Total 156,527 lbs (71.0 t) divisible, assembled and disassembled by hydraulic cylinders controlled from superstructure cab.

Superstructure cab Spacious panoramic cab of composite structure with safety (tinted) glass windows, tiltable cockpit with hydraulically cushioned adjustable seat with heater, engine dependent water heater, engine independent heater (with engine pre-heat), air conditioning, radio/CD-player with MP3/USB/SD card port and Bluetooth hands-free equipment. Complete controls and instrumentation plus LCD graphic display for crane operation.

Electrical system 24 V DC system, 2 batteries. 1 working floodlight on base boom, 2 integrated in crane cab.

Safety devices 'Lift Adjuster', load moment limiter (LMD) with pilot lamp in several colors incl. asymmetric outrigger base, anemometer, slewing area and working limitation with 'Slow-Stop' feature, hoist limit switch, lower limit switch, drum turn indicator, safety valves protect against pipe and hose ruptures.

Optional Equipment (at extra charge)

Boom extensions 35.8 ft to 114.5 ft, offsets 0°, 20° and 40° or hydraulically 0° - 40°, heavy duty jib 15.3 ft, boom extensions HTLJ 28.0 ft to 68.7 ft (hydraulically offsets and telescopic 0° - 60°), selection of hook blocks 11 tons - 220 tons, auxiliary winch (same as main winch), special painting and lettering, outrigger load display.

Further optional equipment available upon request.

Equipo



Chasis portante Construcción de acero de alta resistencia soldado, resistente a la torsión y a la flexión. Sistema de engrase central.

Estabilizadores Estabilizadores hidráulicos de 4 puntos incl. detección de longitud automática y posibilidad de manejo desde ambos lados del chasis portante y desde la cabina de la grúa.
Extensión de los estabilizadores: 8,3 m (y 5,6 m) x 9,0 m.

Motor Mercedes Benz modelo OM 471 LA (EPA Tier 4f), 6 cilindros, diesel, refrigerado por agua. Nominal 390 kW (530 CV) a 1700 min⁻¹. Par 2460 Nm (251 kpm) a 1300 min⁻¹. Potencia del motor según ECE R 120. Depósito de combustible de 600 l. Depósito AdBlue 40 l.

Transmisión Transmisión mecánica tipo ZF-AS Tronic modelo 12 AS 2531 con accionamiento electro - neumático embrague en seco y cambio automático, 12 marchas delanteras y 2 marchas traseras.

Transmisión Caja de distribución (transfer) con 2 relaciones de velocidad.

Tracción 10 x 8 (10 x 6 como opción*)

Ejes

- 1º eje: de dirección, accionado, (*no accionado), con bloqueo diferencial transversal.
- 2º eje: de dirección, accionado, conectar según necesidad, con bloqueo diferencial transversal.
- 3º eje: de dirección, no accionado.
- 4º eje: de dirección, accionado, con bloqueo diferencial transversal y longitudinal.
- 5º eje: de dirección, accionado, con bloqueo diferencial transversal.

Suspensión Suspensión hidroneumática con regulación de nivel.

Frenos Sistema de frenos de disco neumático de doble circuito con indicador electrónico de desgaste. Freno de estacionamiento como freno de acumuladores a resorte accionando en los ejes 2, 4 y 5. Intarder y freno de motor como freno continuo.

Neumáticos (10) 445 / 95 R 25 (16.00 R 25), (ancho 3.00 m).
(10) 525 / 80 R 25 (20.50 R 25), (ancho 3.20 m).

Dirección Hidráulica ZF Servocom de doble circuito. Bomba hidráulica de emergencia accionada por la transmisión. Dirección mecánica al 1o y 2o eje y direccionable al 3o y 4o eje hasta una velocidad de 25 km/h y al 5o eje hasta una velocidad de conducción de 50 km/h.

Cabina Cabina de conductor frontal para dos personas construida en material compuesto de chapa de acero y plástico, acristalamiento de seguridad, bloqueo central, asientos neumáticos, asiento del conductor regulable en múltiples posiciones con función memoria y calefactable, calefacción por agua dependiente del motor, climatizador, dispositivo manos libres con Bluetooth, display multifunción, cámara de marcha atrás, Radio/Reproductor CD con toma USB, elementos de control y mando para el modo de conducción, Regulador de velocidad, sistema automático de frenado.

Sistema eléctrico 24 voltios de corriente continua, 2 baterías, iluminación de la zona de apoyo, alarma acústica para indicar la marcha atrás, sistema de luces con faros bihalógenos, luz LED de marcha diurna, faro LED antiniebla, sistema de bus CAN.

Equipo adicional (con suplemento de precio)
Embrague de remolque, calefacción adicional con precalentamiento del motor, Sistema anti bloqueo ABS, neumáticos 525/80 R 25 (20.5 R 25), rueda de repuesto, pintura especial y rotulación. Otros equipamientos sobre pedido.

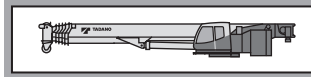

Superestructura Construida en aceros soldados, resistente a la torsión. Corona de giro con rodamiento de una fila de bolas con dientes externos para giro continuo a 360°. Sistema de engrase central.

Motor Mercedes Benz modelo OM 934 LA (EPA Tier 4f), 4 cilindros, diesel, refrigerado por agua.
Las revoluciones aumentan de forma gradual accionando el acelerador. Nominal 145 kW (197 CV) a 1800 min⁻¹. Par 800Nm (82 kpm) a 1200 - 1600 min⁻¹. Potencia del motor según ECE R 120. Depósito de combustible de 250 l. Depósito AdBlue 10 l.

Sistema hidráulico Dieselhidráulico con sistema hidráulico de 3 circuitos, 1 bomba doble de pistones axiales de caudal variable (hidráulicamente regulable) con regulación de caudal total y 1 bomba de pistones axiales, enfriador de aceite.

Mandos 2 palancas de control de tipo joy-stick para movimientos simultáneos de la grúa (4 direcciones), asistidos eléctricamente.

Pluma telescópica 7 secciones, un tramo base y 6 telescópicos de acero de alta resistencia soldado, 1 cilindro hidráulico, los tramos se pueden telescopar hidráulicamente bajo carga. Longitud de 13,2 m a 68,0 m.
Cabeza de pluma con 7 poleas.

Elevación de pluma Mediante un cilindro hidráulico de doble efecto con válvula de retención integrada.

Cabrestante principal Motor hidráulico de pistones axiales y caudal fijo. Tambor del cabrestante con reducción planetaria y frenos de disco múltiples accionados, con sistema libre de elevación. Cable de elevación con sistema fácil de guiado y 'Super-Stop'.

Sistema de giro Motor de cilindrada constante de émbolos axiales, engranaje planetario de tres etapas con freno de servicio y estacionamiento. Circuito hidráulico abierto con desbloqueo del mecanismo giratorio dinámico sin desgaste, Velocidad de giro gradual de 0 a 1,2 min⁻¹.











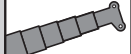

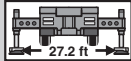
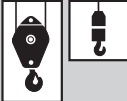



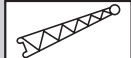





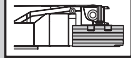

Contrapeso Peso total 71 t divisible, se acciona desde la cabina de la grúa.

Cabina de la grúa Cabina espaciosa y confortable, en construcción de acero y fibra de vidrio, con cristales tintados de seguridad. Asiento de operador regulable amortiguado hidráulicamente, inclinable junto con los instrumentos y mandos, asiento calefactado. Calefacción por agua caliente dependiente e independiente del motor (con precalentamiento del motor), climatización, Radio/Reproductor CD con toma para MP3/USB/tarjeta SD y dispositivo manos libres con Bluetooth. Controles, instrumentos y mandos de conducción como display digital LCD para la operación de la grúa.

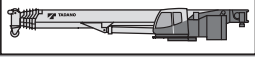
Sistema eléctrico 24 voltios de corriente continua, 2 baterías. 1 faro de trabajo en pluma base, 2 integrados en la cabina de grúa.

Dispositivos de seguridad "Lift Adjuster", limitador del momento de carga (LMC) con luz de señalización tipo semáforo, incl. distancia entre apoyos asimétrica, anemómetro, limitación de la zona de giro y del área de trabajo con función "Slow Stop", interruptor de fin de carrera, interruptor de fin de carrera del torno, indicador de giros del torno de cable. Válvulas de retención en los cilindros hidráulicos.

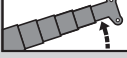
Equipo adicional (con suplemento de precio)
Plumín de 11.8 m a 35.8 m regulable de 0°, 20° y 40° (o hidráulicamente 0° a 40°), plumín de carga pesada de 4,7 m, plumín HTLJ de 8.5 m a 21 m (hidráulicamente regulable y telescopable 0° - 60°), gancho de 10 a 200 to, 2o cabrestante (similar a cabrestante principal), pintura especial y rotulación, control carga (gatos de apoyo).
Otros equipamientos sobre pedido.

 445/95 R 25 (16.00 R 25)	Tires / Size Neumáticos / Tamaño de ruedas		Telescopic boom Pluma telescópica
	Axle load Carga por eje		Outriggers Estabilizadores
	Hook block / Swivel hook Gancho / Gancho de bola		Counterweight Contrapeso
	Carrier speeds Velocidades del chasis		Radius Radio
	Transmission / Gear Transmisión / Marchas		Boom extension Plumin
	Gradeability Superacion de pendientes		Boom extension hydraulically Plumin hidráulicamente
	Off road Todo terreno		Boom extension HTLJ Plumin HTLJ
	On road En carretera		Radius Radio
	Superstructure speeds Velocidades de la superestructura		Counterweight versions Variaciones de contrapeso
	Main winch Cabrestante principal		Carrier chasis
	Auxiliary winch 2° cabrestante		Superstructure superestructura
	Slewing system Sistema de giro		The data are for basic information only and the operator's manual must be consulted before operating this crane. All data and performances refer to the standard crane. The addition of optional and other equipment may affect the performance of the crane.
	Slewing system hydraulically locked Sistema de giro embulonamiento hidráulico		
	Derricking system Elevación de pluma		
	Boom telescoping Telescopaje de pluma		



TADANO AMERICA Corporation

4242 West Greens Road, Houston, TX 77066

Phone: 281-869-0030 Fax: 281-869-0040

www.tadanoamerica.com E-mail: tac.sales@tadano.com

Parts Hotline: 281-869-0033 Service Hotline: 281-869-5925